



**Film Capacitor Solutions
for the World**

C A T A L O G U E 2 0 1 9



Deki Electronics is like a bonsai. Small yet complete.
Complete range of plastic film capacitors with a choice of technologies.

Every branch and twig shaped or eliminated until the chosen image is achieved.
Clear focus on quality and providing solutions.

The image maintained and improved by constant pruning and trimming.
Commitment to training and knowledge enhancement.

Deki at a Glance

Year of establishment: 1984 in technical collaboration with Okaya Electric Industries, Japan.

Capacity: 1.2 billion pieces per annum.

Technologies available: Film foil inductive & non-inductive construction, metallised non-inductive construction

Types of capacitors: Plain Polyester / Metallised Polyester, Plain Polypropylene / Metallised Polypropylene, Plain & Metallised Polypropylene Mixed.

Encapsulation: Wet, powder epoxy coating and box.

Pitch of capacitors: 5 mm to 52.5 mm in epoxy coating and box.

Applications: Blocking / Coupling / Bypassing / Timing circuits / Tuning & oscillation / Filtering & frequency discrimination / Temperature compensation / Interference suppression / Voltage dropper / Snubber / Discharge ignition / Pulse coupling, etc.

Segments covered: Consumer Electronics / Telecom / Lighting (CFL, LED - bulbs, tubelights, street lights) / Medical Electronics / Industrial Electronics / Auto Electronics / IT Hardware / Fan Regulators / Energy meters, etc.

Approvals: ERTL / IATF 16949-2016 / ISO 9001-2015 / ISO 14001-2015 / ISO 18001-2007 / UL & ENEC for X2.

Customer specification approvals: Sony / Sanyo / Philips / Sharp / JVC / Toshiba / Panasonic / Osram, etc.

PPM level: Single Digit.

Exporting To: Europe / Hong Kong / China / Thailand / Philippines / Malaysia / South Korea / Middle East



MANUFACTURING FACILITY

Deki's state-of-the-art manufacturing facility is housed at B-20, Sector 58, Noida, an established industrial township within the National Capital Region of Delhi, India. The capacity has grown steadily from 10 million pieces in 1984 to 1.2 billion pieces per annum as on 1st October 2012.

The plant and machinery are largely imported from Europe, Japan, Taiwan and Korea and every effort to maintain them in the most efficient health is made. The entire maintenance, capital goods and spares development is handled by an Engineering Solutions cell. Strict adherence to well-planned, preventive schedules is ensured.

The housekeeping policy at the plant is based on the 5S concept. The central theme in all such efforts is employee ownership. Fifty eight areas with identified owners ensure that a clean, safe and comfortable working environment is made available. Each member cleans his own workplace and only when necessary, invites help from the housekeeping team.

TQM AND WORK CULTURE

A number of TQM initiatives have been put in place since 1999. Policy deployment is done every year in March based on the company's Single Page Strategy. The single page strategy document lists the strategic direction and the business enablers which will help in achieving the results and the 'must do' actions for the current year. Roadmaps arising out of this are reviewed every month.

External and internal customer satisfaction surveys and employee satisfaction surveys are carried out every six months. Inputs from these surveys are used to make improvement plans which are shared with the customers and employees.

Monthly PPM activity currently takes place with some chosen customers with an objective to maintain our PPM level in single digits.

The management team of Deki is committed to provide a stimulating, learning-oriented, transparent

and professional environment wherein total involvement of each and every member is encouraged. The work culture is oriented towards arriving at decisions by consensus. All members have pledged to strictly follow all decisions so arrived at. A prayer session is held every morning. One of the members is then given an opportunity to share a thought of common interest with the team.

Training, at Deki, is an integral part of the development curriculum with more than 4% of working time spent on it. Training needs are identified during regular interactions and especially during performance appraisals, road map reviews and shop floor meetings. Accordingly, training schedules are drawn up and followed up through coordination to ensure that the identified needs are effectively addressed. Shop floor personnel are engaged in problem solving and improvement teams. These small group activities have helped in the personal development of individuals as they are now equipped with problem solving tools such as 7 QC tools, CEDAC (Cause and Effect diagram with addition of Cards) and DMAIC methodology of 6 Sigma. The 6 Sigma movement was started in October 2009 and more than 45% of the workforce is involved in it.

A moving suggestion box scheme is also in use. All suggestions are collected during the week and presented in the morning assembly on Saturdays. All suggestions found viable are implemented as top priority action and awarded suitably.

QUALITY ASSURANCE

The quality assurance system enforced at Deki, certified in accordance with ISO 9002 since November 1994, has been upgraded to ISO 9001:2015 in December 2017 and quality procedures are laid out in the quality manual. The procedures have been developed taking into consideration international standards, customer requirements and internal performance standards. The system is designed to ensure satisfaction of customers in respect of quality, functional performance, delivery performance, price/performance ratio and overall service satisfaction. Deki team members have been extensively trained to

follow principles of “first time right” and in case of all corrective actions, the PDCA cycle.

Quality assurance is an all pervasive activity at Deki, transcending all vital functions starting from raw material vendor selection, sourcing, incoming inspection through process inspection to final inspection and storage/ despatch. Modern quality tools such as the 7 QC tools, Statistical Process Controls (SPC), Failure Mode and Effects Analysis (FMEA), Design of Experiments (DOE), Cause and Effect Diagram with Addition of Cards (CEDAC) and Six Sigma are used regularly to ensure continual improvement in quality and reliability.

AQL (Acceptable quality level): All outgoing inspection is carried out as per Inspection Standard ISO 2859 / IS 2500 or IEC 410. Sampling plan followed is single sampling for normal inspection. AQL for all electrical properties is 0.1; this ensures that not even a single failure is acceptable.

RELIABILITY

All capacitors are subject to qualification approval test as per relevant IEC standards in order to ensure reliability:

Plain Polyester film / foil capacitors: IEC 384-11

Plain Polypropylene film / foil capacitors: IEC 384-13

Metallised Polyester film capacitors: IEC 384-2

AC & Pulse MPP film capacitors: IEC 384-17

Interference Suppression Capacitors: IEC 384-14

The environmental and endurance testing is carried out periodically at the in-house test laboratory.

TECHNICAL CENTRE

The Deki Technical Centre is recognised as "In-house R&D Unit" since June 2011 by the Department of Scientific & Industrial Research, Government of India. It is primarily responsible for:

Customer Application Support. Assistance is offered to customers for selection of appropriate type of capacitors to suit intended application.

Design and Development of Capacitors. Market requirements are clearly understood and converted

into new designs in close association with customers. All designs are subjected to reliability testing and confirmation as part of the pre-release procedure.

Turnover from new products is being monitored since 2001 and we are consistently generating 25% of our turnover from new products.

Documentation Centre. Specifications of raw material, process specifications and customer product specifications are kept here. In addition, all relevant national and international standards are available in the centre.

Training Cell. Training is undertaken for manufacturing and marketing teams.

Competitor Analysis. Market probe for development around the world and for benchmarking exercises.

Reliability Testing. The centre is equipped with an environmental test laboratory wherein a host of reliability and endurance testing can be carried out. This in-house facility is used for ensuring reliability before release of any new design, input or process.

Approval Coordination. This is also the nodal agency for coordination with all external test facilities for testing and approval of Deki capacitors.

Pilot Plant. The centre has an independent production facility wherein the critical processes can be carried out under controlled conditions.

Technical Face. The centre is the technical interface between the company and its customers. The centre head is responsible for making the company technically proficient.

Technical Seminars are conducted on a regular basis for common interest groups of customers where application aspects specific to the user industry are addressed.

The centre also contributes regularly to the Deki news bulletin **Charge**.

	Series No.	Capacitance Range in μf	Rated Voltage	Marking Example	Page
DC FILM CAPACITORS					
POLYESTER FILM CAPACITORS					
Plain Polyester Film Capacitors (Inductive)	01 (Dip)	0.001-0.47	63VDC-1600VDC	D102K2J	16
Plain Polyester Film Capacitors (Starter Applications for Lighting)	10 (Dip), 11 (Dip)	0.0033-0.0068	630VDC-1000VDC	D332K2J	20
Plain Polypropylene+Plain Polyester Film Capacitors (PEP) (Inductive)	38 (Dip)	0.00068-0.0056	1000VDC-1250VDC	DPEP/102K3A	21
Plain Polyester Film Capacitors (Non-Inductive)	25 (Dip), 31 (Box)	0.001-0.47	100VDC-100VDC	PET-NI/D472K2J	23
Metallized Polyester Film Capacitors	02 (Dip), 06 (Box), 13 (Dip), 14 (Dip), 15 (Box), 16 (Box)	0.001-10	50VDC-1000VDC	MPET/D683J2G	27
Plain Polyester Axial Film Capacitors (Non-Inductive)	131 (Round)	0.001-1	100VDC-1250VDC	DPET-NI/ 0.08/K/1250	34
Metallized Polyester Axial Capacitors MPET	12 (Round), 36 (Flat)	0.01-15	100VDC-630VDC	MPET/D474K2E	35
Fuse Type Metallized Polyester Film Capacitors (MPET-F Series)	88 (Dip)	0.047-3.3	450VDC-630VDC	MPET-F/D105K2I	37
POLYPROPYLENE FILM CAPACITORS					
Plain Polypropylene Film Capacitors (Inductive)	03 (Dip)	0.0001-0.1	100VDC-2000VDC	DPP/821/J2J	39
High Voltage Ceramic Disc Replacement Film Capacitors	134 (Dip)	0.0001-0.02	630VDC-2000VDC	D001/472K/8BC3D	43
Metallized Polypropylene Film Capacitors	04 (Dip), 27 (Box), 113 (Dip)	0.001-4.7	63VDC-630VDC	MPP/D473K2I	45
Fuse Type Metallized Polypropylene Film Capacitors (MPP-F Series)	92 (Dip)	0.047-4.7	450VDC-630VDC	MPP-F/D104K2J	48
Fuse Type Metallized Polypropylene Axial Film Capacitors (MPP-F Axial Series)	118 (Flat)	0.033-15	450VDC-630VDC	MPP-F/D154K2E	50
Metallized Polypropylene Axial Capacitors	40 (Round), 50 (Flat)	0.0047-10	250VDC-1000VDC	MPP/D225K2G	51
AC FILM CAPACITORS					
POLYESTER FILM CAPACITORS					
Metallized Polyester High Capacitance Stability Film Capacitors MPET AC	23 (Box), 24 (Dip)	0.1-1	310VAC	MPET-AC/D224K310V	53
Metallized Polyester Axial Film Capacitors	136 (Round), 148 (Flat)	0.01-4.7	250VAC-440VAC	MPET-AC/D224K310V; MPET-SW-ULTIMA/D325J250VAC	55
POLYPROPYLENE FILM CAPACITORS					
Metallized Polypropylene Film Capacitors MPP AC	17 (Dip), 22 (Box), 112 (Dip)	0.01-2.2	275VAC-440VAC	MPP-AC/D683K275V	56
Metallized Polypropylene High Capacitance Stability Film Capacitors (MPP-AC-Series Construction)	117 (Dip), 122 (Box)	0.022-2.2	305VAC-500VAC	MPP-AC-S/D684K310V	58
Metallized Polypropylene High Capacitance Stability Axial Film Capacitors (MPP-AC-Series Construction Axial Series)	119 (Flat), 135 (Round)	0.022-4.7	305VAC-500VAC	MPP-AC-S/D474K500V	61
Metallized Polypropylene Axial Film Capacitors (MPP-AC Axial series)	52 (Flat), 140 (Round)	0.01-10	250VAC-440VAC	MPP-AC/D104K310V	65
AC & PULSE FILM CAPACITORS					
AC & Pulse Metallized Polypropylene Film Capacitors (MPP/MPP)	18 (Dip), 30 (Box)	0.001-0.15	1000VDC-2000VDC	MPP-MPP/D332J3D	68
AC & Pulse Metallized Polypropylene Film Capacitors (PP/MMPP Series)	05 (Dip), 29 (Box)	0.0001-0.068	1000VDC-2000VDC	PP-MPP/D822J3C	71
AC & Pulse Metallized Polypropylene Film Capacitors (PP/MPP Series)	63 (Dip), 68 (Box)	0.0068-0.47	1000VDC-2000VDC	PP-MPP/D222K3B	74
Plain Polypropylene Film Capacitors (Non-Inductive)	21 (Box), 32 (Dip)	0.0022-0.47	250VDC-1000VDC	PP-NI/D122K250VAC	78
Inductive Self Healing Polypropylene DPSH Capacitors	70 (Dip)	0.0015-0.01	1250VDC-2000VDC	DPSH/102K3D	82
AC & Pulse Metallized Polypropylene Axial Film Capacitors (PP/MPP Series)	129 (Round), 132 (Flat)	0.001-1	400VDC-1600VDC	PP-MPP/D104K3D	84
Plain Polypropylene Axial Film Capacitors (Non-Inductive)	97 (Round)	0.001-2.2	100VDC-1600VDC	PP-NI/D472K2J	85

	Series No.	Capacitance Range in μf	Rated Voltage	Marking Example	Page
RFI FILM CAPACITORS					
Interference Suppression Capacitors (ENEC APPROVED) Class X2	07 (Box)	0.01-10	310VAC	 IS/MKP X2 D 104 K 310VAC 40/110/56/B	88
Interference Suppression Capacitors (UL APPROVED) Class X2	20 (Box)	0.0047-10	275VAC-310VAC	 IS/MKP X2 D 334 K 310VAC 40/105/56/B	90
Interference Suppression Capacitors Class Y2	33 (Box)	0.001-0.033	305VAC	IS /MKP Y2/D222K/300VAC	92
Interference Suppression Capacitors Class Y2	133 (Dip)	0.00022-0.0068	305VAC	D001/222K/7AY02	93
FAN REGULATOR CAPACITORS					
Metallized Polyester Film Capacitors Economic Type (MPET-EC)	57,81	1-6.8	250VAC	MPET- EC/D105K250VAC	94
Metallized Polyester Film Capacitors Economic Type (MPET-EC-Ultima)	77,82,83	1-4.6	250VAC	MPET- EC-ULTIMA/D105K250VAC	95
Metallized Polyester Film Capacitors Switch Type (MPET-SW)	46,102,98	0.75-5.6	250VAC	MPET-SW /D105K250 VAC	97
Metallized Polyester Film Capacitors Switch Type (MPET-SW-Ultima)	86, 96, 103, 104, 106	0.75-5.6	250VAC	MPET-SW-ULTIMA/D105J250VAC	98
Metallized Polypropylene Film Capacitors Switch Type (MPP-SW)	04, 64,105	1-5.6	250VAC	MPP/D255J250VAC	99
Metallized Polypropylene Film Capacitors Switch Type (MPP-SW-Ultima)	84	1-4.6	250VAC	MPP-ULTIMA/D155K250VAC	101
Metallized Polypropylene Film Capacitors (MPP-Ultima)	74,44,93,95	1-4.6	250VAC	MPP-ULTIMA/D155J250VAC	102
AUTOMOTIVE CAPACITORS					
CDI FILM CAPACITORS					
Metallized Polyester and Polypropylene CDI Film Capacitors	08(MPET), 09(MPP)	0.68-3.3	400VDC	CDI-MPET/D155K2G; CDI-MPP/D155K2G	104
NOISE SUPPRESSOR CAPACITORS					
Metallized Polyester Film Capacitors Automotive	37	Customized	100VDC-250VDC	DEKI/MPET/2.0/K/100	105
MOTOR RUN CAPACITORS					
Metallized Polypropylene Motor Run Film Capacitors	123(Rectangular), 137 (Round Box)	1-10	440VAC	DEKI/MPP-MR/2.5 μF J440VAC	106
DC LINK FILM CAPACITORS					
Metallized Polypropylene DC Link Capacitors	91	10-120	450VDC-1100VDC	DC LINK/D755K450V	108
SNUBBER CAPACITORS					
Metallized Polypropylene IGBT Snubber Capacitors	121	0.047-5.6	700VDC-3000VDC	 IGBT-SNUBBER PP-MMPP 1.0 μF /K/1000V	102
Metallized Polypropylene IGBT Snubber Capacitors	150	1.5-10	700VDC-3000VDC	 IGBT-SNUBBER MPP-MPP 1.0 μF /K/1000V	112

Guide to Film Capacitors

Application / Function desired

Expected Capacitor Parameter

Circuit Diagram

BLOCKING

Once the capacitor is charged it passes no more DC (except for minor leakage, i.e., IR) hence C provides a high series impedance for limiting low frequency AC or DC current.

↑ IR
High insulation resistance.

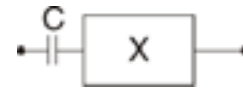

Deki Range

For $0.0001\mu\text{F} \leq C \leq 0.1\mu\text{F}$ — Plain Polypropylene Film Capacitors.

For $0.001\mu\text{F} \leq C \leq 0.47\mu\text{F}$ — Plain Polyester Film Capacitors.

For $0.001\mu\text{F} \leq C \leq 10\mu\text{F}$ — Metallised Polyester Film Capacitors.

COUPLING

The capacitor actually acts as a conductor to AC (because of moving particles present in the dielectric) i.e., C provides a low series impedance for transferring AC signal information from one system to another.

Low dissipation factor ($\tan \delta$).
Low inductance.

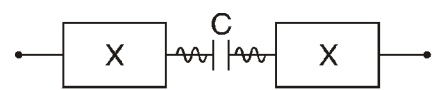

Deki Range

For $0.0001\mu\text{F} \leq C \leq 0.1\mu\text{F}$ — Plain Polypropylene Film Capacitors.

For $0.001\mu\text{F} \leq C \leq 0.47\mu\text{F}$ — Plain Polyester Film Capacitors.

For $0.001\mu\text{F} \leq C \leq 10\mu\text{F}$ — Metallised Polyester Film Capacitors.

BYPASSING

Capacitor provides a low series impedance AC path around the given circuit element.

Low dissipation factor ($\tan \delta$).
Low inductance.
High insulation resistance.

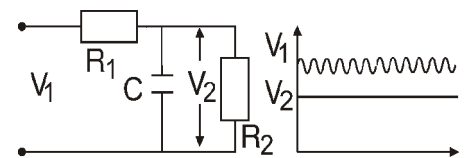

Deki Range

For $0.0001\mu\text{F} \leq C \leq 0.1\mu\text{F}$ — Plain Polypropylene Film Capacitors.

For $0.001\mu\text{F} \leq C \leq 0.47\mu\text{F}$ — Plain Polyester Film Capacitors.

For $0.001\mu\text{F} \leq C \leq 10\mu\text{F}$ — Metallised Polyester Film Capacitors.

TIMING CIRCUITS

In timing circuits capacitors are used to introduce time delays.

Stability of electrical characteristics (with reference to ambient temperature, etc.).
Close capacitance tolerance

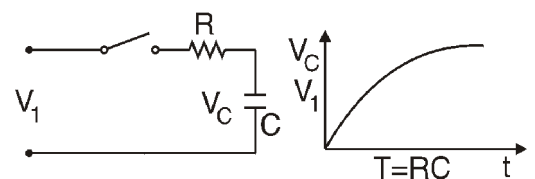

Deki Range

For $0.0001\mu\text{F} \leq C \leq 0.1\mu\text{F}$ — Plain Polypropylene Film Capacitors.

For $0.001\mu\text{F} \leq C \leq 10\mu\text{F}$ — Metallised Polypropylene Film Capacitors.

TUNING AND OSCILLATION

In tuning circuits capacitors and inductors are used to select the desired frequency signal.

Stability of electrical characteristics (with reference to ambient temperature and frequency).
Close capacitance tolerance.



Deki Range

For $0.0001\mu\text{F} \leq C \leq 0.1\mu\text{F}$ — Plain Polypropylene Film Capacitors.

For $0.001\mu\text{F} \leq C \leq 10\mu\text{F}$ — Metallised Polypropylene Film Capacitors.

Guide to Film Capacitors (contd.)

Application / Function desired

SAMPLE AND HOLD CIRCUIT

In this application C retains the stored energy.

Expected Capacitor Parameter

Low dielectric absorption.

Circuit Diagram

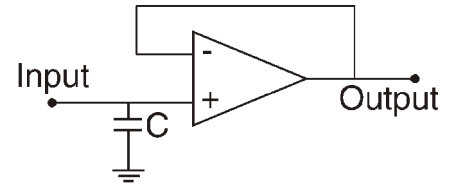

Deki Range

For $0.0001\mu\text{F} \leq C \leq 0.1\mu\text{F}$ — Plain Polypropylene Film Capacitors.

For $0.001\mu\text{F} \leq C \leq 10\mu\text{F}$ — Metallised Polypropylene Film Capacitors.

FILTERING AND FREQUENCY

DISCRIMINATION

Capacitor filter network designed for the frequency band $f_L - f_H$

Stability of electrical characteristics.
Low dissipation factor.
Close capacitance tolerance.

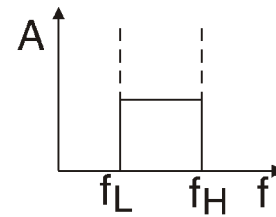

Deki Range

For $0.0001\mu\text{F} \leq C \leq 0.1\mu\text{F}$ — Plain Polypropylene Film Capacitors.

For $0.001\mu\text{F} \leq C \leq 10\mu\text{F}$ — Metallised Polypropylene Film Capacitors.

TEMPERATURE COMPENSATION

Circuit design utilises change of capacitance with temperature

Linear temperature coefficient
Stability of electrical values

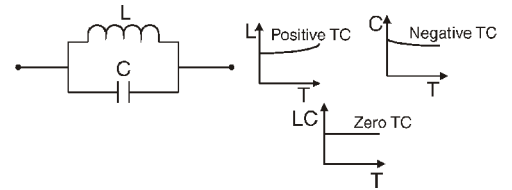

Deki Range

For $0.0001\mu\text{F} \leq C \leq 0.1\mu\text{F}$ — Plain Polypropylene Film Capacitors.

For $0.001\mu\text{F} \leq C \leq 10\mu\text{F}$ — Metallised Polypropylene Film Capacitors.

INTERFERENCE SUPPRESSION

Capacitors are connected across the mains input to suppress the interference generated by appliances or in the mains.

Should be able to handle high transient pulses.
High reliability against active and passive flammability.

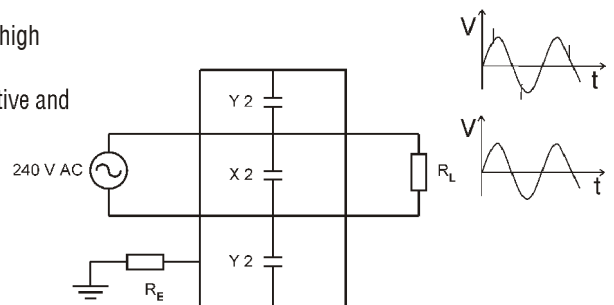

Deki X2 Range

For $0.0047\mu\text{F} \leq C \leq 10\mu\text{F}$ — Interference Suppression Capacitors Class X2

Deki Y2 Range

For $0.00022\mu\text{F} \leq C \leq 0.033\mu\text{F}$ — Interference Suppression Capacitors Class Y2

VOLTAGE DROPPER

Capacitors are connected in series to drop the input voltage. Used mainly in electronic energy meters and fan regulators.

Low loss factor.
Good reliability.
Flame retardant.

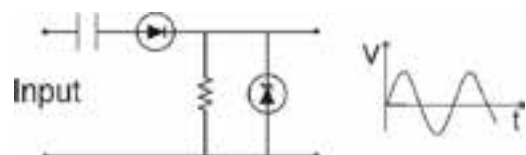

Deki Range

For rated voltage less than 250V AC — $0.0047\mu\text{F} \leq C \leq 10\mu\text{F}$ — Interference Suppression Capacitors Class X2.

For rated voltage more than 250V AC — $0.022\mu\text{F} \leq C \leq 4.7\mu\text{F}$ — Metallized Polypropylene High Capacitance Stability Film Capacitors.

For rated voltage less than 220V AC and higher capacitance — $0.022\mu\text{F} \leq C \leq 4.7\mu\text{F}$ — Metallized Polyester High Capacitance Stability Film Capacitors.

Guide to Film Capacitors (contd.)

Application / Function desired

TV FLY-BACK TUNING

Expected Capacitor Parameter

Low dissipation factor.
High dielectric strength.
High pulse rise time rating.

Circuit Diagram

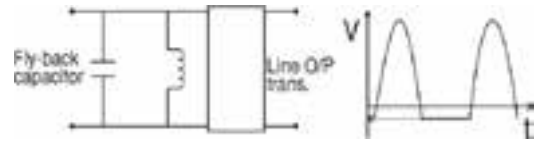

Deki Range

For $0.001\mu\text{F} \leq C \leq 0.15\mu\text{F}$ — AC & Pulse Metallized Polypropylene Film Capacitors (MPP/MPP Series).

$0.0068\mu\text{F} \leq C \leq 0.47\mu\text{F}$ — AC & Pulse Metallized Polypropylene Film Capacitors (PP/MPP Series).

TV S-CORRECTION

Low dissipation factor.
Stability of electrical characteristics.
Good current carrying capability.



Deki Range

For $0.001\mu\text{F} \leq C \leq 0.15\mu\text{F}$ — AC & Pulse Metallized Polypropylene Film Capacitors (MPP/MPP Series).

For $0.001\mu\text{F} \leq C \leq 2.2\mu\text{F}$ — Plain Polypropylene Film Capacitors Non-Inductive (PP-NI).

SNUBBER APPLICATION

Low dissipation factor.
High dielectric strength.
High pulse rise time rating.

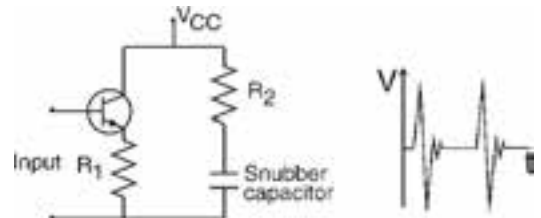

Deki Range

For $0.0001\mu\text{F} \leq C \leq 0.1\mu\text{F}$ — Polypropylene Film Capacitors (PP/MPP Series).

For $0.001\mu\text{F} \leq C \leq 2.2\mu\text{F}$ — Plain Polypropylene Film Capacitors Non-Inductive (PP-NI).

For $0.0068\mu\text{F} \leq C \leq 0.47\mu\text{F}$ — AC & Pulse Metallized Polypropylene Film Capacitors (PP/MPP Series).

For $0.047\mu\text{F} \leq C \leq 10\mu\text{F}$ — Metallized Polypropylene IGBT Snubber Capacitors.

CAPACITOR DISCHARGE IGNITION

During the positive half cycle the capacitor is charged to full voltage. Then, during the negative half cycle energy stored in the capacitor is discharged through the ignition coil.

Good current carrying capability.
Good response for fast discharge.

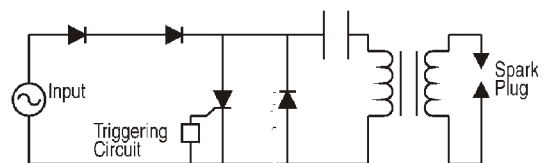

Deki Range

For discharge current of 80 amps — $1\mu\text{F} \leq C \leq 3.3\mu\text{F}$ — CDI Capacitors (Metallized Polyester Film Capacitors).

For discharge current of 100 amps and above — $0.68\mu\text{F} \leq C \leq 3.3\mu\text{F}$ — CDI Capacitors (Metallized Polypropylene Film Capacitors).

Guide to Film Capacitors (contd.)

Application / Function desired

PULSE COUPLING

Coupling/decoupling of high energy, fast rise pulses

Expected Capacitor Parameter

Good pulse and AC characteristics.
High voltage proof.
Low dissipation factor.

Circuit Diagram

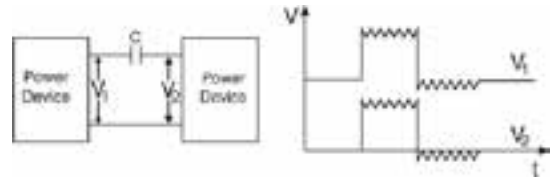

Deki Range

For Low Power Signal

Good dv/dt

For $0.0001\mu\text{F} \leq C \leq 0.1\mu\text{F}$ — Plain Polypropylene Film Capacitors.

Good dv/dt and V_{RMS} of 700V AC — $0.001\mu\text{F} \leq C \leq 0.15\mu\text{F}$ — AC & Pulse Metallized Polypropylene Film Capacitors (MPP/MPP Series)

Very High dv/dt and V_{RMS} of 500V AC — $0.0068\mu\text{F} \leq C \leq 0.47\mu\text{F}$ — AC & Pulse Metallized Polypropylene Film Capacitors (PP/MPP Series)

LAMP CIRCUIT

For pre-heating and striking application.

Good pulse and AC characteristics.
Low dissipation factor.
High temperature rating.

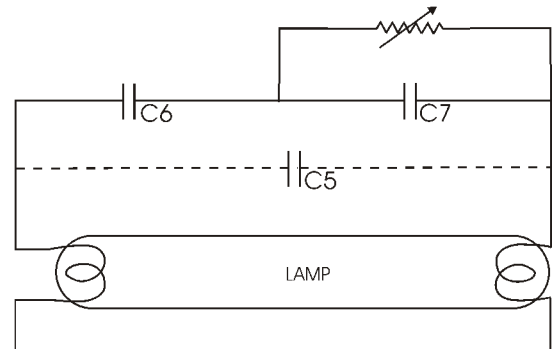

Deki Range

For C5 - $0.0022\mu\text{F}$ - $0.0068\mu\text{F}$ (1000V DC - 1600V DC).

C6 - $0.0047\mu\text{F}$ - $0.01\mu\text{F}$ (630V DC - 1600V DC).

C7 - $0.0018\mu\text{F}$ - $0.0068\mu\text{F}$ (630V DC - 1600V DC).

Recommended Capacitors

PP Film Foil Inductive type for temp $\leq 85^\circ\text{C}$

PET Film Foil Inductive for high temperature with low voltage and low frequency, say 40 kHz and $60 V_{\text{RMS}}$.

PEP Film Foil Inductive for high temperature upto 110°C with high voltage and high frequency say 40 kHz and $110 V_{\text{RMS}}$.

FAN REGULATOR

For speed control of fan.

Good self healing properties.
Smaller in size.
Higher break down voltage.
Flame proof.

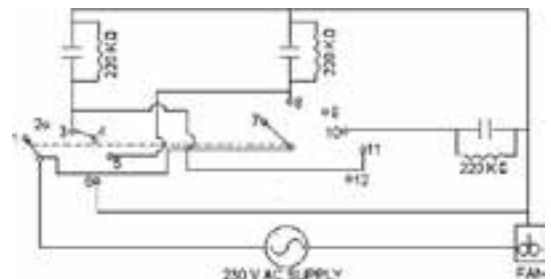

Deki Range

$0.75\mu\text{F}$ - $5.6\mu\text{F}$ — Metallized Polyester Film Capacitors (MPET-EC, MPET-SW).

$1.0\mu\text{F}$ - $5.6\mu\text{F}$ — Metallized Polyester Film Capacitors (MPET-EC-Ultima, MPET-SW-Ultima).

$1.0\mu\text{F}$ - $5.6\mu\text{F}$ — Metallized Polypropylene Film Capacitors (MPP-SW).

$1.0\mu\text{F}$ - $4.6\mu\text{F}$ — Metallized Polypropylene Film Capacitors (MPP-Ultima, MPP-SW-Ultima).

FILM CAPACITOR BASICS

General information

Plastic film capacitors are generally subdivided into film/foil capacitors and metallised film capacitors. The following description gives brief information about their technical features.

Film/foil capacitors

Film/foil capacitors generally consist of two aluminium foil electrodes with plastic film material used as dielectric.

In order to guarantee the necessary safety and reliability of a capacitor it is essential to use a sufficient film thickness.

Typical advantages that relatively large film/foil capacitors have over smaller metallised capacitors is their higher insulation resistance, their better capacitance stability and their good current carrying capability. High voltage and good pulse handling capability are additional features of these capacitors. Lead connections are made by means of welding.

Metallised film capacitors

In contrast to film/foil capacitors, where aluminium foils are used as electrodes, the electrodes of metallised film capacitors consist of a thin metal layer (0.03 micron thickness, approx.) which is vacuum deposited on the dielectric film. The connection of metallised capacitors is accomplished by means of a metal spraying process and by welding the leads on to the sprayed ends.

The main advantages of metallised capacitors are,

- 1) relatively small dimensions, a result of vacuum deposited electrodes, and,
- 2) self healing property.

Owing to the self healing property, relatively thinner films can be used for metallised capacitors than film/foil capacitors.

DC Capacitor

A capacitor designed essentially for application with direct voltage.

AC Capacitor

A capacitor designed essentially for application with alternating voltage.

Climatic category

Indicates the conditions applicable to climatic testing of capacitors as per the relevant standards. It is indicated as a combination of test temperatures for cold proof, heat proof and test days for damp proof (steady state) which the capacitor will withstand.

The category = XX / YYY / ZZ

XX = Test temperature for cold proof

YYY = Test temperature for heat proof

ZZ = Test days applicable

Category temperature range

Denotes the range of ambient temperature for which the capacitor has been designed to operate continuously. This is defined by the temperature limits of the appropriate category.

Rated temperature

The maximum ambient temperature at which the rated voltage may be continuously applied.

Lower category temperature

The minimum ambient temperature for which a capacitor has been designed to operate continuously.

Upper category temperature

The maximum ambient temperature for which a capacitor has been designed to operate continuously.

Self healing

The process by which the electrical properties of the capacitor, after a local breakdown of the dielectric, are rapidly restored to those before the breakdown.

Rated voltage

The maximum direct voltage or the maximum r.m.s. alternating voltage or peak value of pulse voltage which may be applied continuously to a capacitor at any temperature between the lower category temperature and the rated temperature.

FILM CAPACITOR BASICS

Rated capacitance

The capacitance value for which the capacitor has been designed and which is usually indicated upon it.

The capacitance shall be measured at one of the following frequencies unless otherwise prescribed by the relevant specification:

$$C_R \leq 1 \text{ nF}: 1\text{MHz}$$

$$1 \text{ nF} < C_R \leq 10 \text{ }\mu\text{F}: 1 \text{ kHz}$$

$$C_R > 10 \text{ }\mu\text{F}: 50\text{Hz or } 100\text{Hz}$$

The tolerance on all frequencies for measuring purposes shall not exceed $\pm 20\%$.

The measuring voltage shall not exceed 3% of rated voltage or $5 V_{RMS}$ (whichever is lower) unless otherwise prescribed in the relevant specification.

Insulation resistance

The insulation resistance is the quotient of an applied DC voltage to the current flowing after a specified time.

$$R (\text{insulation}) = \frac{V (\text{applied voltage})}{I (\text{leakage current})}$$

$$\begin{aligned} \text{The time constant (S)} &= M \Omega \times Mf \\ &= \text{Insulation Resistance} \times \text{Rated Capacitance} \end{aligned}$$

Before this measurement is made, the capacitors shall be fully discharged. The insulation resistance shall be measured, at the following measuring voltage, between the points specified.

Voltage rating of capacitor	Measuring voltage
$U_R < 10 \text{ V}$	$U_R \pm 10\%$
$10 \text{ V} \leq U_R < 100 \text{ V}$	$10 \pm 1 \text{ V}$
$100 \text{ V} \leq U_R < 500 \text{ V}$	$100 \pm 15 \text{ V}$
$500 \text{ V} \leq U_R$	$500 \pm 50 \text{ V}$

The insulation resistance shall be measured after the voltage has been applied for $1 \text{ min} \pm 5 \text{ sec}$.

Tangent of loss angle ($\tan \delta$)

The dissipation factor or tangent of loss angle is the power loss of the capacitor divided by the reactive power of the capacitor at a sinusoidal voltage of specified frequency.

Equivalent circuit of capacitor

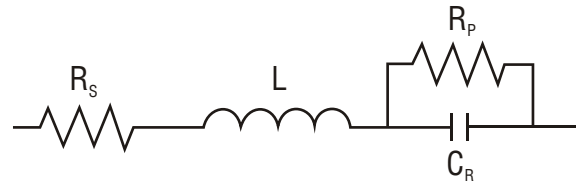

$\tan \delta = \omega CR = 2 \times \pi \times f \times C \times R$ where R is the Equivalent Series Resistance.

The tangent at loss angle shall be measured under the same conditions as those given for the measurement of capacitance at one or more frequencies as prescribed in the detailed specifications.

The measuring method shall be such that the error does not exceed 10% of the specified value or 0.0001, whichever is higher.

Quality factor

The reciprocal of tangent of loss angle

$$Q = \frac{1}{\omega CR}$$

Equivalent series resistance (ESR)

The ESR is the resistive part of the equivalent series circuit and is temperature and frequency dependent. The ESR can be calculated from the dissipation factor ($\tan \delta$) as follows:

$$ESR = \tan \delta / \omega C$$

Power dissipation

The power dissipated by a capacitor is a function of the voltage across or the current (I) through the equivalent series resistance ESR.

$$P = v \times C \times \tan \delta \times U^2$$

$$P = 2 \times \pi \times f \times C \times \tan \delta \times U^2$$

where f = frequency, $\tan \delta$ = maximum value specified, U = rated voltage

TYPICAL PARAMETERS

Capacitance change $\Delta C/C$ versus Temperature θ

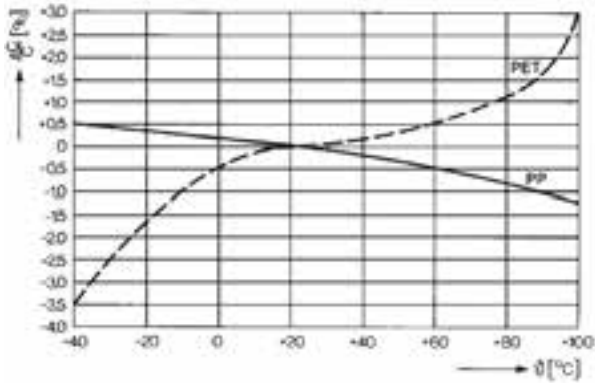

Capacitance change $\Delta C/C$ versus Frequency f

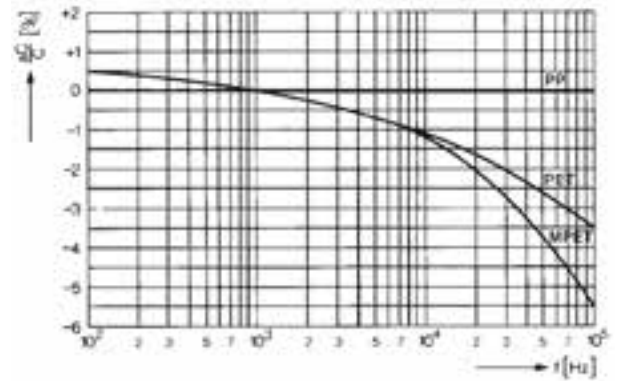

Dissipation factor $\tan \delta$ versus Temperature θ
(measured at 1 kHz)

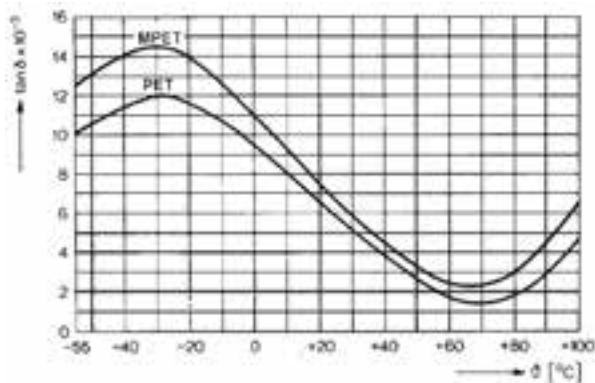

Dissipation factor $\tan \delta$ versus Frequency f

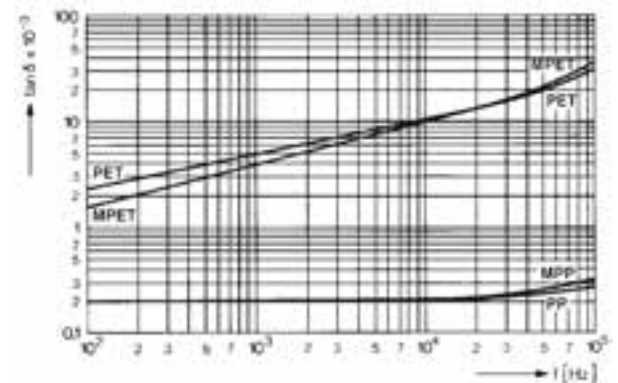

Time constant τ versus Temperature θ

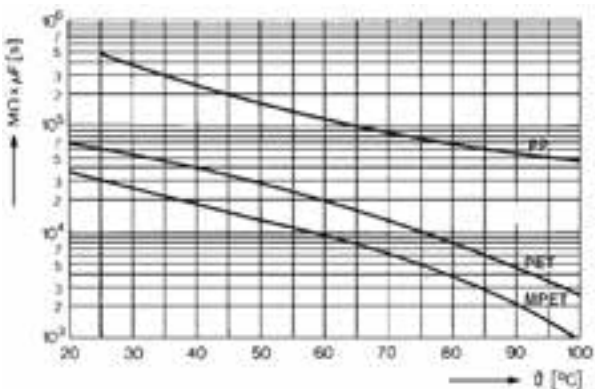

Legend

- PET:** Plain polyester film / foil capacitor
- PP:** Plain polypropylene film / foil capacitor
- MPET:** Metallised polyester film capacitor
- MPP:** Metallised polypropylene film capacitor

STORAGE AND OPERATING CONDITIONS OF CAPACITORS

Storage Time: ≤2 years from the date of marking

Storage Temperature: -40 to + 80° C

Storage Humidity: ≤70% (Average per year)

≤85% (For 30 full days randomly distributed throughout the year without condensation).

The levels of humidity must be reduced according to the ambient temperature as per the graph.

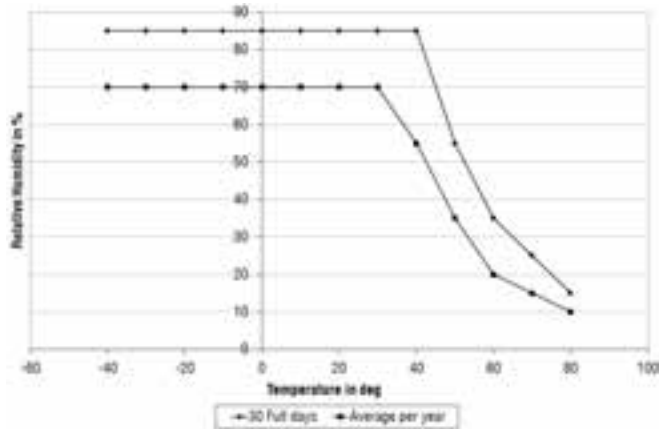

Special Operating conditions (Humid Environment):

If the capacitors are used for a long time in a humid ambient, the capacitor might absorb humidity and oxidize the metal electrodes causing the failure of the capacitor.

In case of AC application/ X2 application, high humidity would increase the corona effect which will cause a drop in the capacitance value and increase in the dissipation factor.

The normal operating conditions should be:

Working Temp in ° C	Rel. Humidity in %
25° C	70% (average for a year)
30° C	90% (2 weeks continuously)

If the operating conditions differ from the above, please contact for our Technical Assistance.

Plain Polyester Film Capacitors

Series Code
01

Inductive

Main Application

Blocking, bypassing, filtering, coupling and decoupling, interference suppression in low voltage application, low pulse application.

Construction

Film/foil inductive type construction with aluminum foil as electrode and polyester (PET) film as dielectric, coated with epoxy resin.

Climatic Category

40/105/56

Rated and Maximum Temperature Rating

85°C and 105°C

Applicable Specification

IEC 384-11

Capacitance Value

0.001µF-0.47µF

Capacitance Tolerance

±5%,±10%

Insulation Resistance

Minimum Insulation Resistance R_{IS} V_R
(or) time constant $T = C_R \times R_{IS}$ ≤ 100 V DC
at 25° C, relative humidity $\leq 70\%$ ≥ 250 V DC

Rated Voltage

63VDC-1600VDC

Voltage Proof

Between terminals: 2 times of rated voltage for 2 sec.

Tan δ

0.8% (maximum) at 1 kHz.

Life Test Conditions

(Loading at elevated temperature)

Loaded at 1.5 times of rated voltage at 85° C or 1.5 times of category voltage at 100° C 1000 hours. Category voltage is 80% of rated voltage.

After the Test

$\Delta C/C$: $\leq 5\%$ of initial value.

Increase of Tan δ : ≤ 0.01 or 1.2 times the value measured before the test, whichever is higher.

Insulation resistance: $\geq 50\%$ of the initial value mentioned in IR chart.

Approvals

Capacitors tested at ERTL (North) as per IEC 384-11.

$C_R \leq 0.33 \mu F$	$C_R > 0.33 \mu F$
30 GΩ	10000 s
100 GΩ	10000 s

Derating graph for Plain Polypropylene Film Capacitors Non-Inductive

Max. Voltage (Vrms) vs. Frequency
(Sinusoidal Waveform at $T \leq 55^\circ C$)

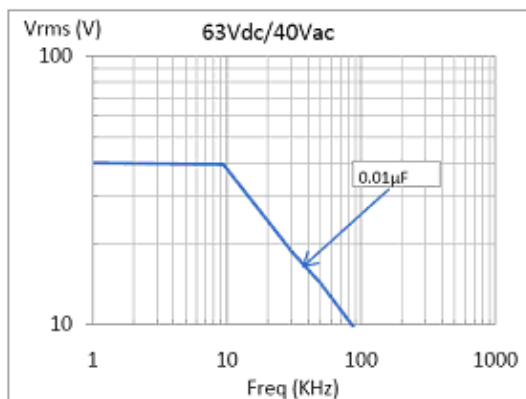

Max. Current (Irms) vs. Frequency
(Sinusoidal Waveform at $T \leq 55^\circ C$)

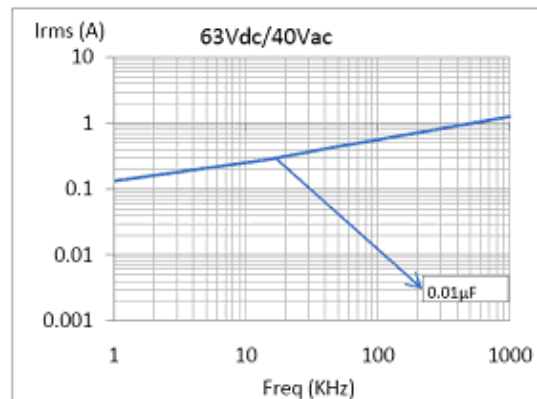

Max. Voltage (Vrms) vs. Frequency
(Sinusoidal Waveform at $T \leq 55^\circ\text{C}$)

Max. Current (Irms) vs. Frequency
(Sinusoidal Waveform at $T \leq 55^\circ\text{C}$)

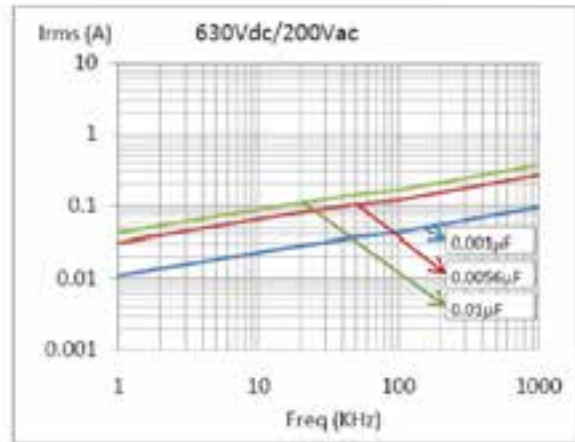
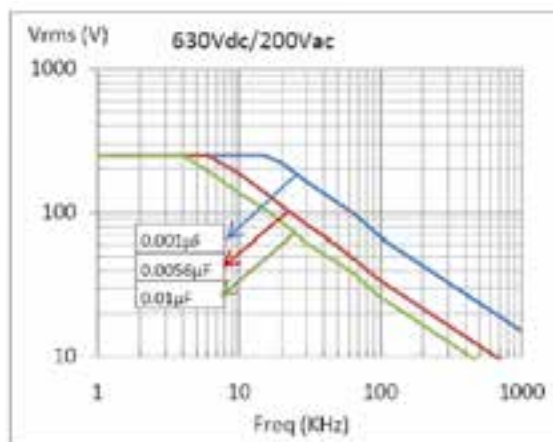
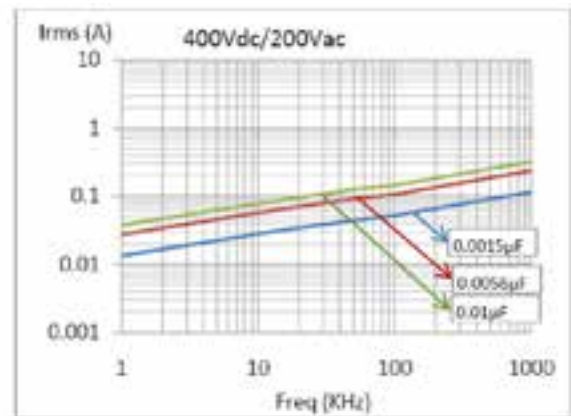
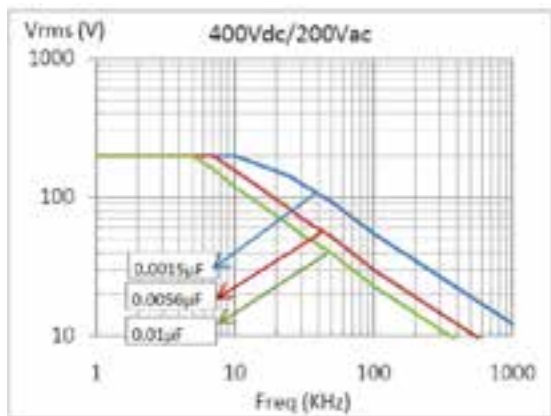
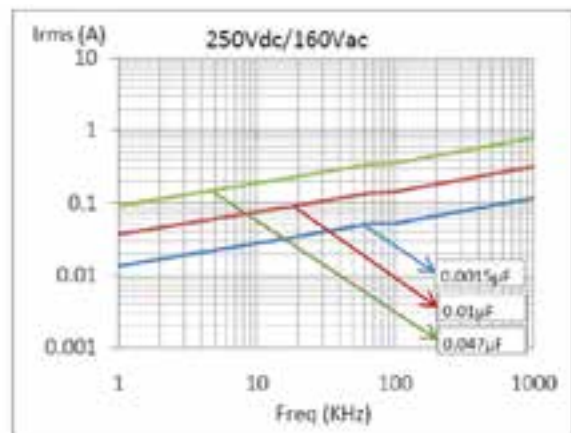
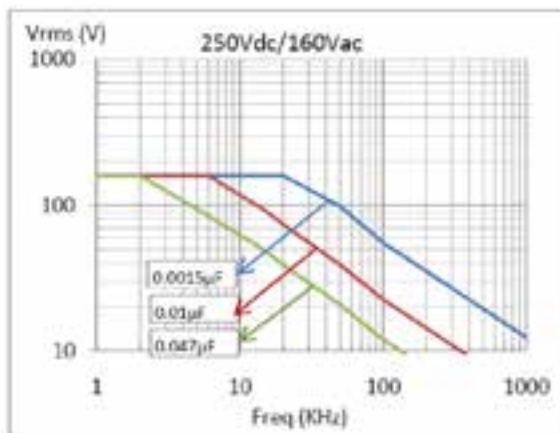
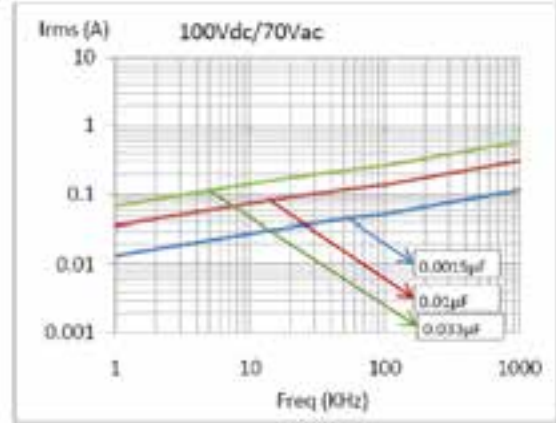
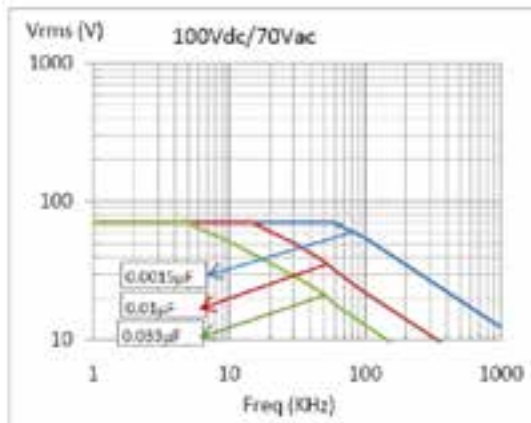

Max. Voltage (Vrms) vs. Frequency
(Sinusoidal Waveform at $T \leq 55^\circ\text{C}$)

Max. Current (Irms) vs. Frequency
(Sinusoidal Waveform at $T \leq 55^\circ\text{C}$)

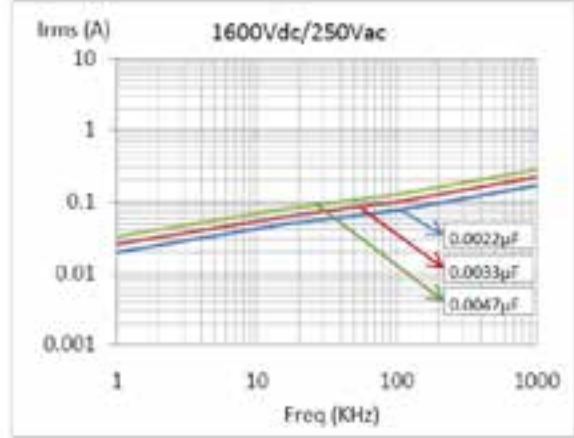
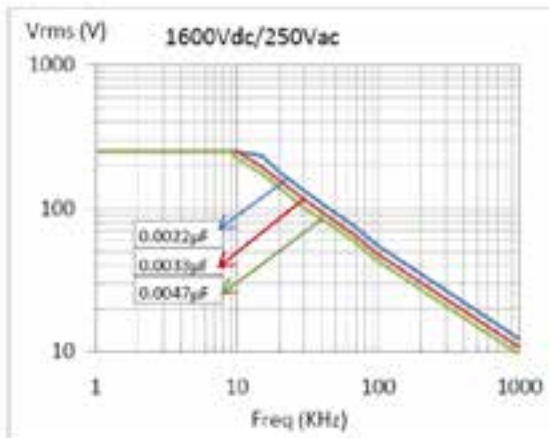
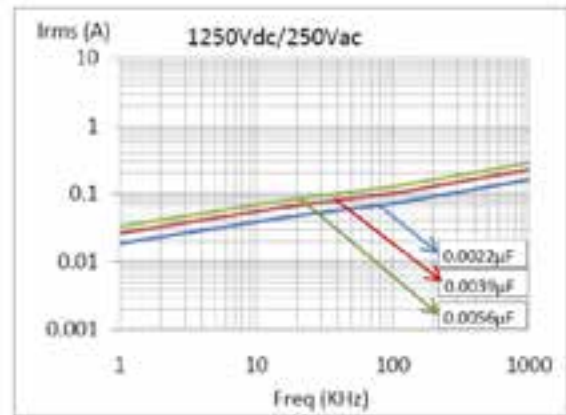
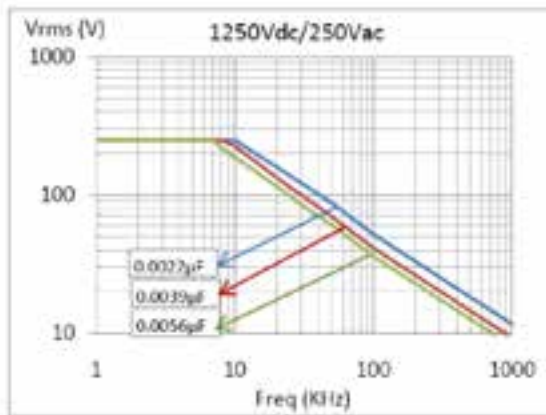
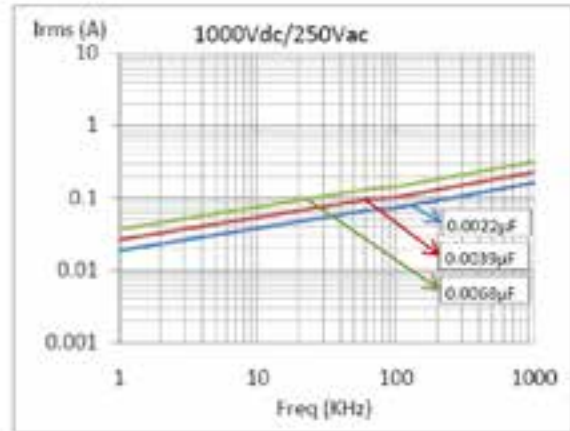
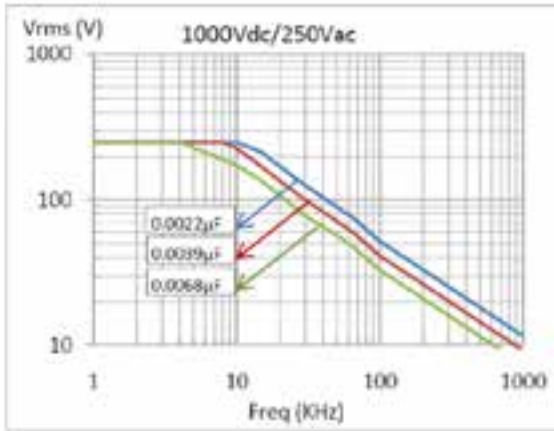

**Ordering code and packaging unit: Plain Polypropylene Film Capacitors
(Inductive) Series Code 01**

Rated Voltage	Rated Cap. (µF)	Dimensions (mm)							DV/DT V/µs	Wt. g	Ordering code	Packing units	
		W max.	H max.	L max.	d ±0.05	S ±0.5	F max.	Ammo				Bulk	
63V DC	0.1	11.0	14.0	6.0	0.5	7.0	5.0	10000	0.76	01 104 +1J*^	2000	2000	
	100V DC	0.001	6.5	11.5	3.5	0.5	4.0	5.0	10000	0.22	01 102 +2A*^	5000	2000
		0.0033	6.5	11.5	3.5	0.5	4.0	5.0	10000	0.32	01 332 +2A*^	5000	2000
		0.0068	7.5	11.5	3.5	0.5	4.0	5.0	10000	0.25	01 682 +2A*^	5000	2000
		0.01	7.5	11.5	4.0	0.5	4.0	5.0	10000	0.35	01 103 +2A*^	4500	2000
		0.033	7.5	13.0	5.0	0.5	5.0	5.0	10000	0.40	01 333 +2A*^	4000	2000
		0.068	10.0	14.0	5.5	0.5	7.0	5.0	10000	0.60	01 683 +2A*^	2000	2000
		0.082	11.0	14.0	6.0	0.5	7.0	5.0	10000	0.70	01 823 +2A*^	2000	2000
		0.1	11.0	14.0	6.0	0.5	7.0	5.0	10000	0.75	01 104 +2A*^	2000	2000
		0.22	12.0	17.0	6.5	0.5	8.5	-	10000	1.56	01 224 +2A*^	-	1000
0.47	16.0	19.0	8.5	0.5	11.5	-	10000	2.88	01 474 +2A*^	-	400		
250V DC	0.001	6.5	11.5	3.5	0.5	4.0	5.0	10000	0.28	01102 +2E*^	5000	2000	
	0.0033	6.5	12.0	3.5	0.5	4.0	5.0	10000	0.28	01 332 +2E*^	5000	2000	
	0.01	7.5	13.0	4.0	0.5	5.0	5.0	10000	0.35	01 103 +2E*^	2500	2000	
	0.022	9.0	13.0	4.5	0.5	6.0	5.0	10000	0.45	01 223 +2E*^	2500	2000	
	0.047	11.0	14.0	6.0	0.5	7.0	7.5	10000	0.80	01 473 +2E*^	2000	2000	
	0.056	13.0	14.0	6.5	0.5	7.0	-	10000	0.90	01 563 +2E*^	-	2000	
	0.1	13.0	18.0	6.5	0.5	9.0	-	10000	1.30	01 104 +2E*^	-	1000	
400V DC	0.001	6.5	11.5	3.5	0.5	4.0	5.0	10000	0.28	01 102 +2G*^	5000	2000	
	0.0033	6.5	11.5	4.0	0.5	4.0	5.0	10000	0.35	01 332 +2G*^	5000	2000	
	0.0056	8.5	11.5	4.0	0.5	5.5	5.0	10000	0.45	01 562 +2G*^	4000	2000	
	0.01	8.5	12.0	4.5	0.5	6.5	5.0	10000	0.65	01 103 +2G*^	4000	2000	
	0.047	12.0	15.0	8.0	0.5	7.0	-	10000	1.00	01 473 +2G*^	-	1000	
	0.056	10.0	15.0	8.0	0.5	7.5	-	10000	1.30	01 563 +2G*^	-	1000	
630V DC	0.01	15.0	18.0	9.0	0.5	11.0	-	10000	2.16	01 104 +2G*^	-	400	
	0.001	6.5	11.5	3.5	0.5	4.0	5.0	10000	0.28	01 102 +2J*^	5000	2000	
	0.0033	8.5	15.0	4.5	0.5	5.0	5.0	10000	0.45	01 332 +2J*^	4000	2000	
	0.0068	11.0	15.0	5.0	0.5	5.5	5.0	10000	0.55	01 682 +2J*^	2000	2000	
	0.01	10.0	15.0	5.5	0.5	7.5	7.5	10000	0.75	01 103 +2J*^	2000	2000	
1000V DC	0.033	13.0	15.0	8.0	0.5	8.5	-	10000	1.70	01 333 +2J*^	-	1000	
	0.0022	8.5	15.0	5.0	0.5	5.0	5.0	10000	0.48	01 222 +3A*^	4000	2000	
	0.0033	9.0	15.0	5.0	0.5	5.0	5.0	10000	0.62	01 332 +3A*^	4000	2000	
	0.0047	10.0	15.0	6.0	0.5	5.0	5.0	10000	0.72	01 472 +3A*^	4000	2000	
1250V DC	0.0068	12.0	15.0	6.5	0.5	5.0	5.0	10000	0.84	01 682 +3A*^	3000	2000	
	0.0022	8.5	15.0	5.0	0.5	5.0	5.0	10000	0.48	01 222 +3B*^	3000	2000	
	0.0033	9.5	15.0	6.0	0.5	5.0	5.0	10000	0.65	01 332 +3B*^	2500	2000	
	0.0047	11.0	15.0	7.0	0.5	5.0	5.0	10000	0.84	01 472 +3B*^	1500	2000	
1600V DC	0.0056	11.0	15.0	7.0	0.5	5.0	5.0	10000	0.85	01 562 +3B*^	1500	2000	
	0.0022	9.5	15.0	6.0	0.5	5.0	5.0	10000	0.70	01 222 +3C*^	1500	2000	
	0.0033	10.0	18.0	6.5	0.5	5.0	5.0	10000	0.80	01 332 +3C*^	1500	2000	
	0.0047	12.0	18.0	7.5	0.5	7.5	5.0	10000	1.15	01 472 +3C*^	1000	2000	

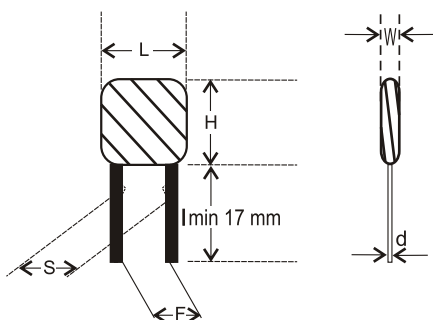

Plain Polyester Film Capacitors

Series Code
10, 11

Starter Applications for Lighting

Main Application

Suitable for radio interference suppression in starters for fluorescent lamps, compact fluorescent lamps and PL lamps.

Construction

Film/foil inductive type construction with aluminum foil as electrode and polyester (PET) film as dielectric coated with epoxy resin or impregnated in transparent epoxy resin.

Climatic Category

40/105/21

Rated and Maximum Operating Temperature

85°C and 105°C

Applicable Specification

IEC 384-11, IEC-68

Capacitance Value

0.0033µF-0.0068µF

Capacitance Tolerance

±10%, ±20%

Insulation Resistance

Minimum Insulation Resistance R_{IS}
(or) time constant $T = C_R \times R_{IS}$
at 25° C, relative humidity ≤70%

V_R
≥500 V DC

Rated Voltage

630VDC-1000VDC

Voltage Proof

Between terminals: 2 times of rated voltage for 2 sec.

Tan δ

0.8% (maximum) at 1 kHz.

Life Test Conditions

(Loading at elevated temperature)

Loaded at 1.5 times of rated voltage at 85° C or
1.5 times of category voltage at 100° C 1000 hours.
Category voltage is 80% of rated voltage.

After the Test

$\Delta C/C$: ≤ 5% of initial value.

Increase of Tan δ: ≤ 0.01 or 1.2 times the value
measured before the test, whichever is higher.

Insulation resistance: ≥ 50% of the value mentioned in
IR chart.

Endurance Test

Deactivated lamp test as per IEC 155-1993.

Ordering code and packaging unit: Plain Polyester Film Capacitors (Starter Applications for Lighting) Dip Type

Rated Voltage	Rated Cap. (µF)	Dimensions (mm)								Ordering code	Packing units	
		W max.	H max.	T max.	d ±0.05	S ±0.5	F ±0.5	DV/DT V/µs	Wt. g		Ammo	Bulk
Epoxy Coated - Series Code 10												
630 VDC/	0.0033	8.5	15	4.5	0.5	5.0	5.0	10000	0.56	10 332 +2J*^	4500	2000
250 VAC	0.0047	8.5	15	4.5	0.5	5.0	5.0	10000	0.64	10 472 +2J*^	4500	2000
	0.006	8.5	15	4.5	0.5	5.5	5.0	10000	0.72	10 602 +2J*^	2000	2000
Only Impregnated - Series Code 11												
630 VDC/	0.003	10.0	14	4.0	0.5	5.0	5.0	10000	0.50	11 302 +2J*^	4500	2000
250 VAC	0.0033	8.5	15	4.5	0.5	5.0	5.0	10000	0.50	11 332 +2J*^	4500	2000
	0.0047	8.5	15	4.5	0.5	5.0	5.0	10000	0.60	11 472 +2J*^	4500	2000
	0.006	8.5	15	4.5	0.5	5.5	5.0	10000	0.65	11 602 +2J*^	2000	2000
1000 VDC/	0.005	9.05	19	5.0	0.5	5.5	5.0	10000	0.68	11 502 +3A*^	4000	2000
250 VAC												

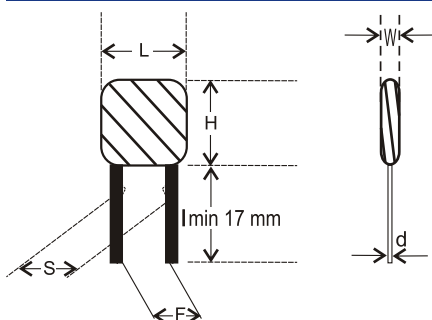

Plain Polypropylene+Plain Polyester Film Capacitors

Series Code
38

PEP - Inductive

Main Application

Oscillator, timing and LC/RC filter circuits, snubber circuits, high frequency coupling of fast digital and analog ICs. Wherever stable capacitance with respect to frequency and temperature is required. Mainly used in CFL and where stable temperature characteristics are required.

Construction

Film/foil inductive type construction with aluminum foil as electrode and PET + PP film as mixed dielectric coated with epoxy resin.

Climatic Category

40/100/56

Rated and Maximum Operating Temperature

85°C and 100°C

Capacitance Value

0.00068µF-0.0056µF

Capacitance Tolerance

±2.5%, ±5%, ±10%

Insulation Resistance

Minimum Insulation Resistance R_{IS} $C_R \leq 0.33\mu F$
 (or) time constant $T = C_R \times R_{IS}$ 100 GΩ
 at 25° C, relative humidity ≤70%

Rated Voltage

1000VDC-1250VDC

Voltage Proof

Between terminals: 2 times of rated voltage.

Tan δ

0.25% (maximum) at 1.0 kHz.

Life Test Conditions

(Loading at elevated temperature)

Loaded at 1.5 times of rated voltage at 85° C or 1.5 times of category voltage at 100° C for 1000 hours. Category voltage is 80% of rated voltage.

After the Test

$\Delta C/C \leq 3\%$.

Increase of Tan δ: ≤ 1.4 times the value measured before the test.

Insulation resistance: ≥ 50% of the value mentioned in IR chart.

Max. Voltage (Vrms) vs. Frequency
(Sinusoidal Waveform at T ≤ 55° C)

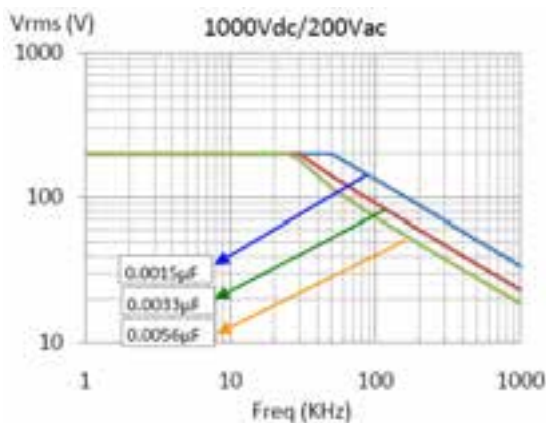

Max. Current (Irms) vs. Frequency
(Sinusoidal Waveform at T ≤ 55° C)

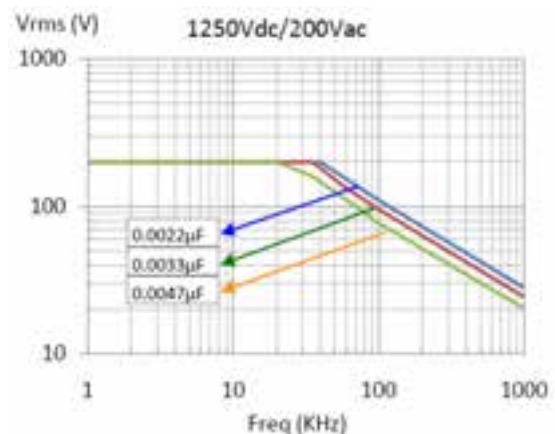

Ordering codes and packaging units
Plain Polypropylene+Plain Polyester Film Capacitors PEP - Inductive

Rated Voltage	Rated Cap. (µF)	Dimensions (mm)							DV/DT V/µs	Wt. g	Ordering code	Packing units	
		W ±0.5	H ±0.5	L ±0.5	d ±0.05	S ±0.5	F 0.8/-0.2	Ammo				Bulk	
1000V DC	0.00068	8.5	13.5	5.0	0.5	5.0	5	10000	0.040	38 681 +3A [^]	3500	2000	
	0.001	7.5	13.0	4.0	0.5	4.5	5	10000	0.350	38 102 +3A [^]	5000	2000	
	0.0022	8.5	14.0	5.0	0.5	5.0	5	10000	0.400	38 222 +3A [^]	3000	2000	
	0.0033	8.5	14.0	5.5	0.5	5.0	5	10000	0.450	38 332 +3A [^]	3000	2000	
	0.0047	9.5	14.0	6.5	0.5	5.0	5	10000	0.600	38 472 +3A [^]	2500	2000	
	0.0056	9.5	14.0	6.5	0.5	5.0	5	10000	0.650	38 562 +3A [^]	2000	2000	
1250V DC	0.00068	8.5	13.5	5.0	0.5	5.0	5	10000	0.550	38 681 +3B [^]	3500	2000	
	0.001	7.5	13.0	4.0	0.5	5.0	5	10000	0.045	38 102 +3B [^]	3500	2000	
	0.0022	8.5	14.0	5.0	0.5	5.0	5	10000	0.055	38 222 +3B [^]	3000	2000	
	0.0033	9.5	15.0	6.0	0.5	5.0	5	10000	0.550	38 332 +3B [^]	2000	2000	
	0.0047	9.5	14.0	6.5	0.5	5.0	5	10000	0.750	38 472 +3B [^]	1500	2000	
	0.0056	9.5	14.0	6.5	0.5	5.0	5	10000	0.820	38 562 +3B [^]	1500	2000	

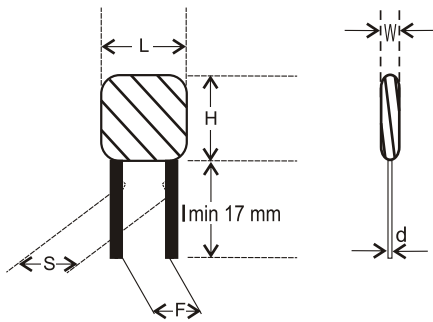

Plain Polyester Film Capacitors

Series Code
25, 31

Non-Inductive

Main Application

Blocking, bypassing, filtering, coupling and decoupling, interference suppression in low voltage application, low pulse application.

Construction

Film/foil inductive type construction with aluminium foil as electrode and polyester (PET) film as dielectric coated with flame retardant epoxy resin or encased in flame retardant box.

Climatic Category

40/105/56

Rated and Maximum Operating Temperature

85°C and 105°C

Applicable Specification

IEC 384-11

Capacitance Value

0.001µF-0.47µF

Capacitance Tolerance

±5%, ±10%

Insulation Resistance

Minimum Insulation Resistance R_{IS}	V_R	$C_R \leq 0.1 \mu F$	$C_R > 0.1 \mu F$
(or) time constant $T = C_R \times R_{IS}$	$\leq 100 \text{ V DC}$	30 GΩ	10000 s
(at 25° C, relative humidity $\leq 70\%$)	$\geq 250 \text{ V DC}$	100 GΩ	10000 s

Rated Voltage

100VDC-1000VDC

Voltage Proof

Between terminal 2 times of rated voltage for 2 sec.

Tan δ

0.8% (maximum) at 1 kHz.

Life Test Conditions

(Loading at elevated temperature)

Loaded at 1.5 times of rated voltage at 85° C for 1000 hours.

After the Test

$\Delta C/C: \leq 5\%$ of initial value.

Change in Tan δ: ≤ 0.01 or 1.2 times the value measured before the test, whichever is higher.

Insulation resistance: $\geq 50\%$ of the value mentioned in IR chart.

Derating Graph for Plain Polyester Film Capacitors (Non-Inductive)

Max. Voltage (Vrms) vs. Frequency
(Sinusoidal Waveform at $T \leq 85^\circ \text{C}$)

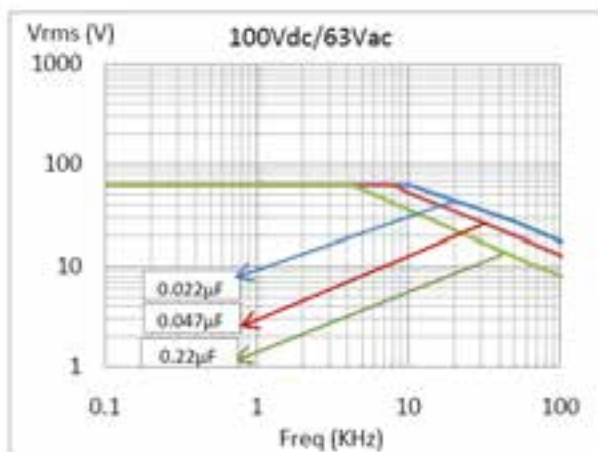

Max. Current (Irms) vs. Frequency
(Sinusoidal Waveform at $T \leq 85^\circ \text{C}$)

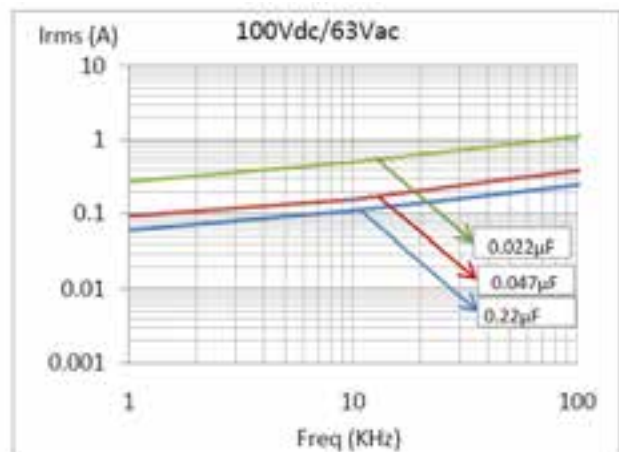

Max. Voltage (Vrms) vs. Frequency
(Sinusoidal Waveform at $T \leq 85^\circ \text{C}$)

Max. Current (Irms) vs. Frequency
(Sinusoidal Waveform at $T \leq 85^\circ \text{C}$)

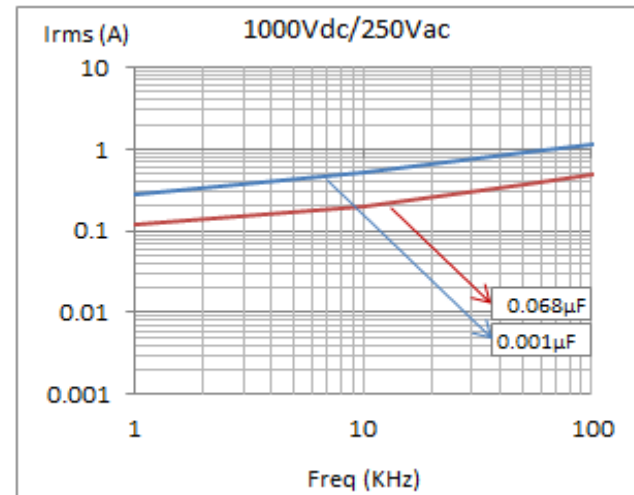
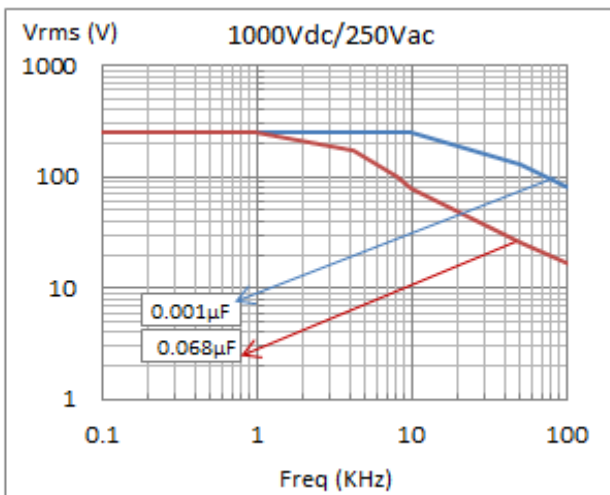
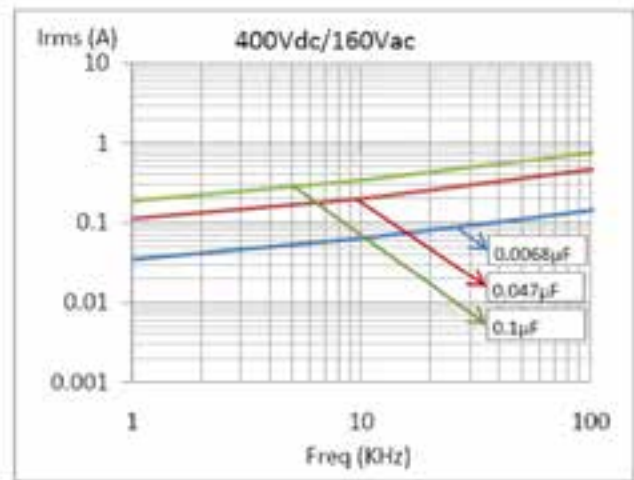
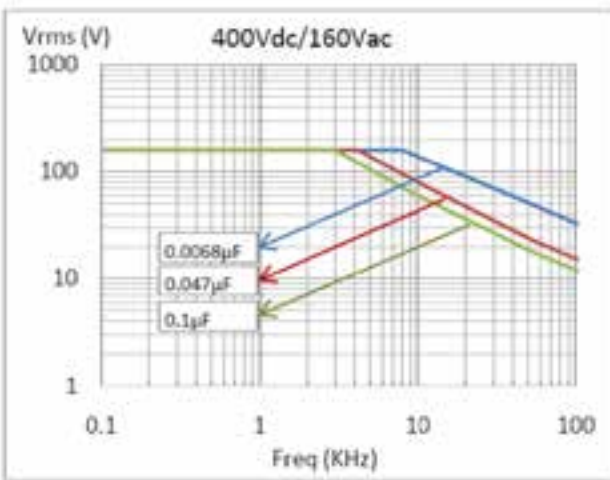
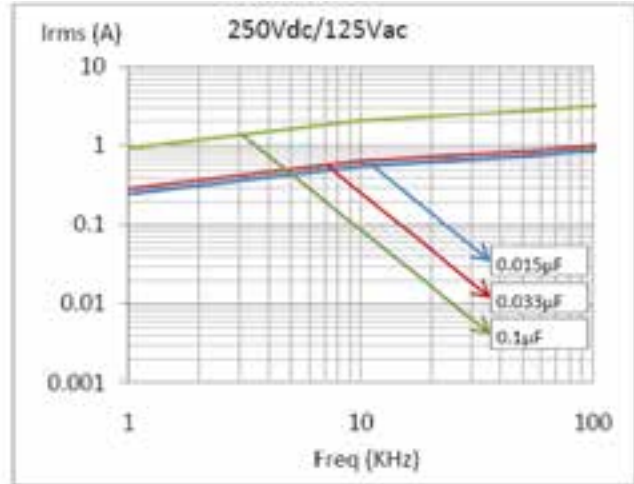
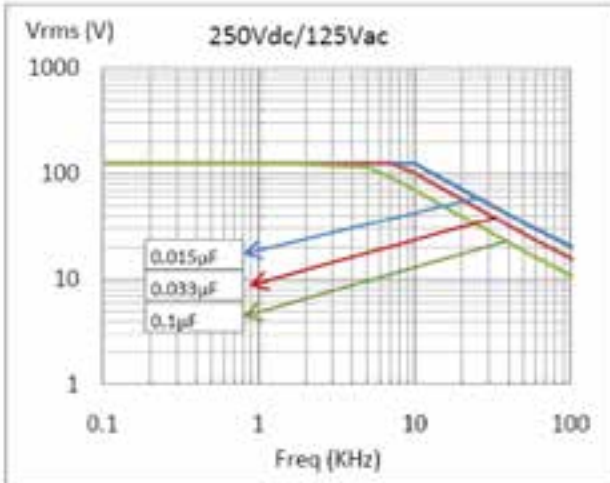

**Ordering code and packing units: Plain Polyester Film Capacitors
(Non-inductive) Dip Type Series Code 25**

Rated Voltage	Rated Cap. (µF)	Dimensions (mm)							DV/DT V/µs	Wt. g	Ordering code	Packing units	
		W max.	H max.	L max.	d ±0.05	S ±1.0	F ±0.5	Ammo				Bulk	
100 VDC	0.015	4.5	9.5	14	0.6	10.0	10	10000	0.4	25 153 +2A [^]	2000	500	
	0.022	5.5	10.0	14	0.6	10.0	10	10000	0.6	25 223 +2A [^]	2000	500	
	0.033	6.0	10.5	14	0.6	10.0	10	10000	0.7	25 333 +2A [^]	2000	500	
	0.047	7.0	11.5	14	0.6	10.0	10	10000	0.9	25 473 +2A [^]	2000	500	
	0.1	7.5	13.0	19	0.8	15.0	15	10000	1.7	25 104 +2A [^]	2000	500	
	0.22	7.5	15.5	27	0.8	22.5	-	10000	3.2	25 224 +2A [^]	1000	250	
	0.33	9.0	17.0	27	0.8	22.5	-	10000	4.4	25 334 +2A [^]	500	250	
	0.47	11.0	19.0	27	0.8	22.5	-	10000	6.0	25 474 +2A [^]	500	250	
250 VDC	0.01	5.0	9.5	14	0.6	10.0	10	10000	0.5	25 103 +2E [^]	2000	500	
	0.015	5.5	10.0	14	0.6	10.0	10	10000	0.6	25 153 +2E [^]	2000	500	
	0.022	6.5	11.0	14	0.6	10.0	10	10000	0.8	25 223 +2E [^]	2000	500	
	0.033	5.5	11.0	19	0.8	15.0	15	10000	1.1	25 333 +2E [^]	2000	250	
	0.047	7.0	12.5	19	0.8	15.0	15	10000	1.4	25 473 +2E [^]	2000	250	
	0.1	7.5	15.0	27	0.8	22.5	-	10000	2.7	25 104 +2E [^]	1000	250	
	0.22	10.0	18.0	27	0.8	22.5	-	10000	4.5	25 224 +2E [^]	500	250	
	0.33	10.5	19.5	32	0.8	27.5	-	10000	6.3	25 334 +2E [^]	500	250	
400 VDC	0.0068	6.5	12.0	14	0.6	10.0	10	10000	0.5	25 682 +2G [^]	2000	500	
	0.01	6.0	10.5	14	0.6	10.0	10	10000	0.7	25 103 +2G [^]	2000	500	
	0.015	6.5	12.5	19	0.6	15.0	15	10000	0.9	25 153 +2G [^]	2000	250	
	0.022	7.5	13.5	19	0.8	15.0	15	10000	1.2	25 223 +2G [^]	2000	250	
	0.033	7.5	16.0	19	0.8	15.0	15	10000	1.6	25 333 +2G [^]	2000	250	
	0.039	8.5	14.0	19	0.8	15.0	15	10000	1.8	25 393 +2G [^]	2000	250	
	0.047	9.0	16.0	19	0.8	15.0	15	10000	2.1	25 473 +2G [^]	1000	250	
	0.1	11.0	19.0	19	0.8	15.0	15	10000	3.8	25 104 +2G [^]	500	250	
630 VDC	0.0047	6.0	10.5	14	0.6	10.0	10	10000	0.7	25 472 +2J [^]	2000	500	
	0.0068	7.0	11.5	14	0.6	10.0	10	10000	0.9	25 682 +2J [^]	2000	500	
	0.01	6.5	13.0	19	0.8	15.0	10	10000	1.2	25 103 +2J [^]	2000	500	
	0.015	7.5	13.0	19	0.8	15.0	15	10000	1.5	25 153 +2J [^]	2000	250	
	0.022	7.5	14.5	19	0.8	15.0	15	10000	2.0	25 223 +2J [^]	1000	250	
	0.033	7.5	15.5	27	0.8	22.5	-	10000	2.8	25 333 +2J [^]	1000	250	
	0.047	9.0	17.0	27	0.8	22.5	-	10000	3.5	25 473 +2J [^]	500	250	
	0.1	11.5	20.5	32	0.8	27.5	-	10000	6.2	25 104 +2J [^]	500	250	

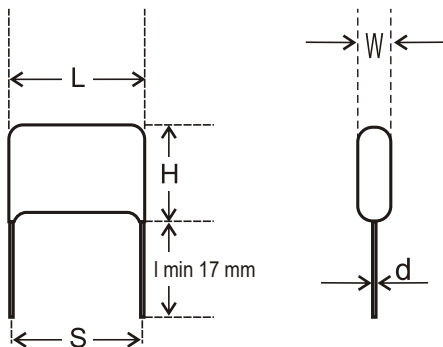

**Ordering code and packing units: Plain Polyester Film Capacitors
(Non-inductive) Box Type Series Code 31**

Rated Voltage	Rated Cap. (µF)	Dimensions (mm)							DV/DT V/µs	Wt. g	Ordering code	Packing units Bulk
		W ±0.5	H ±0.5	L ±0.5	d ±0.5	S ±0.5	F ±0.5					
100VDC	0.001	5.0	11.0	13.0	0.6	10.0	10.0	10000	1.50	31 102 + 2A ^A	500	
	0.0022	5.0	11.0	13.0	0.6	10.0	10.0	10000	1.50	31 222 + 2A ^A	500	
	0.0047	5.0	11.0	13.0	0.6	10.0	10.0	10000	1.50	31 472 + 2A ^A	500	
	0.01	6.0	12.0	13.0	0.6	10.0	10.0	10000	1.80	31 103 + 2A ^A	500	
	0.047	6.0	12.0	13.0	0.6	10.0	10.0	10000	2.00	31 473 + 2A ^A	500	
	0.068	6.0	12.0	18.0	0.8	15.0	15.0	10000	2.70	31 683 + 2A ^A	250	
	0.22	7.0	16.0	26.5	0.8	22.5	22.5	10000	5.89	31 224 + 2A ^A	250	
250VDC	0.47	9.0	18.0	32.0	0.8	27.5	27.5	10000	10.5	31 474 + 2A ^A	250	
	0.001	5.0	11.0	13.0	0.6	10.0	10.0	10000	1.50	31 102 + 2E ^A	500	
	0.0022	5.0	11.0	13.0	0.6	10.0	10.0	10000	1.50	31 222 + 2E ^A	500	
	0.0047	5.0	11.0	13.0	0.6	10.0	10.0	10000	1.50	31 472 + 2E ^A	500	
	0.01	6.0	12.0	13.0	0.6	10.0	10.0	10000	1.80	31 103 + 2E ^A	500	
	0.047	6.0	12.0	13.0	0.6	10.0	10.0	10000	2.00	31 473 + 2E ^A	500	
	0.068	6.0	12.0	18.0	0.8	15.0	15.0	10000	2.70	31 683 + 2E ^A	250	
400VDC	0.22	7.0	16.0	26.5	0.8	22.5	22.5	10000	5.89	31 224 + 2E ^A	250	
	0.47	9.0	18.0	32.0	0.8	27.5	27.5	10000	10.5	31 474 + 2E ^A	250	
	0.001	5.0	11.0	13.0	0.6	10.0	10.0	10000	1.50	31 102 + 2G ^A	500	
	0.0022	5.0	11.0	13.0	0.6	10.0	10.0	10000	1.50	31 222 + 2G ^A	500	
	0.0047	5.0	11.0	13.0	0.6	10.0	10.0	10000	1.50	31 472 + 2G ^A	500	
	0.068	6.0	12.0	18.0	0.8	15.0	15.0	10000	2.70	31 683 + 2G ^A	250	
	0.1	8.5	14.5	18.0	0.8	15.0	15.0	10000	6.14	31 104 + 2G ^A	250	
630VDC	0.22	8.5	17.0	26.5	0.8	22.5	22.5	10000	7.95	31 224 + 2G ^A	250	
	0.47	11.0	20.0	32.0	0.8	27.5	27.5	10000	14.84	31 474 + 2G ^A	250	
	0.001	5.0	11.0	13.0	0.6	10.0	10.0	10000	1.50	31 102 + 2J ^A	500	
	0.0022	5.0	11.0	13.0	0.6	10.0	10.0	10000	1.50	31 222 + 2J ^A	500	
	0.0047	5.0	11.0	13.0	0.6	10.0	10.0	10000	1.50	31 472 + 2J ^A	500	
1000VDC	0.01	6.0	12.0	13.0	0.6	10.0	10.0	10000	1.90	31 103 + 2J ^A	500	
	0.047	8.5	14.5	18.0	0.8	15.0	15.0	10000	4.48	31 473 + 2J ^A	250	
	0.1	8.5	17.0	26.5	0.8	22.5	22.5	10000	7.60	31 104 + 2J ^A	250	
	0.22	11.0	20.0	32.0	0.8	27.5	27.5	10000	14.10	31 224 + 2J ^A	250	
	0.001	6.0	12.0	13.0	0.6	10.0	10.0	10000	1.50	31 102 + 3A ^A	500	
0.068	12.0	22.0	26.0	0.8	22.5	22.5	10000	7.67	31 683 + 3A ^A	250		

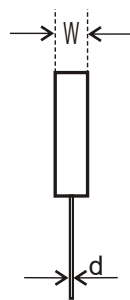
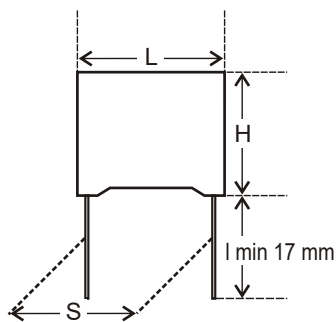

Metalized Polyester Film Capacitors

Series Code
14, 16, 13, 15, 02, 06

5.0mm, 7.5mm, 10-27.5mm pitch

Main Application

Blocking, bypassing, filtering, timing, coupling and decoupling, interference suppression in low voltage applications, low pulse operations.

Construction

Low inductive cell of metallized polyester film coated with flame retardant epoxy resin or encased in flame retardant box.

Climatic Category

40/105/56

Rated and Maximum Operating Temperature

85°C and 105°C

Applicable Specification

IEC 384-2. CACT approved for telecom applications from 10 to 27.5 mm pitch.

Capacitance Value

0.001µF-10µF

Capacitance Tolerance

±5%, ±10%

Insulation Resistance

Minimum Insulation Resistance R_{IS} V_R
(or) time constant $T = C_R \times R_{IS}$ ≤ 100 V DC
at 25° C, relative humidity $\leq 70\%$ > 100 V DC

Rated Voltage

50VDC-1000VDC

Voltage Proof

Between terminals: 1.6 times of rated voltage for 2 sec.

Tan δ

Frequency (kHz)	$C_R < 0.1\mu F$	$0.1\mu F \leq C_R \leq 1\mu F$	$C_R > 1\mu F$
At 1	0.8%	1.0%	1.5%
At 10	1.5%	1.5%	-
At 100	3.0%	-	-

Life Test Conditions

(Loading at elevated temperature)

Loaded at 1.25 times of rated voltage at 85° C or 1.25 times of category voltage at 100° C for 1000 hours.

Category voltage is 80% of rated voltage at 100°C as per IEC 384-2.

After the Test

$\Delta C/C$: $\leq 5\%$ of initial value.

Increase of Tan δ: ≤ 0.003 , $C_R \leq 1\mu F$; ≤ 0.002 , $C_R > 1\mu F$;

Insulation resistance: $\geq 50\%$ of the initial value mentioned in IR chart.

$C_R \leq 0.33\mu F$ $C_R > 0.33\mu F$

3750 MΩ 1250 s

7500 MΩ 2500 s

Derating graph for metallized polyester film capacitors (Sub miniature) 5.0 mm pitch Series Code 14, 16

Max. Voltage (Vrms) vs. Frequency (Sinusoidal Waveform at $T \leq 55^\circ C$)

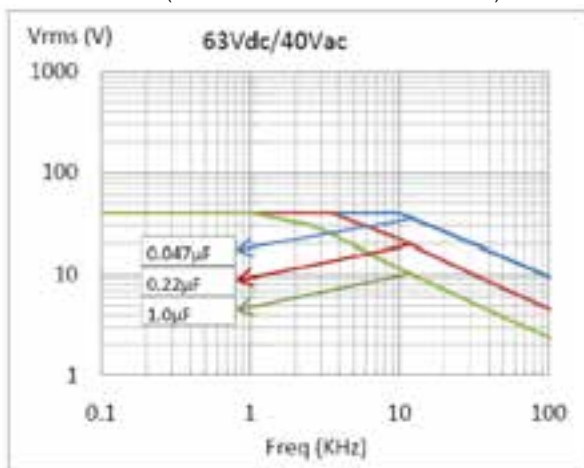

Max. Current (Irms) vs. Frequency (Sinusoidal Waveform at $T \leq 55^\circ C$)

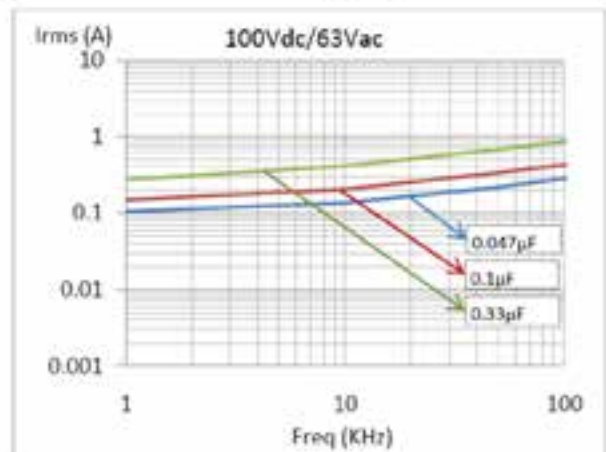
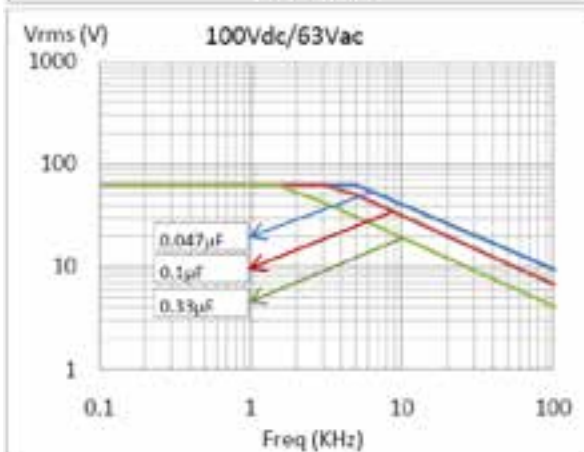
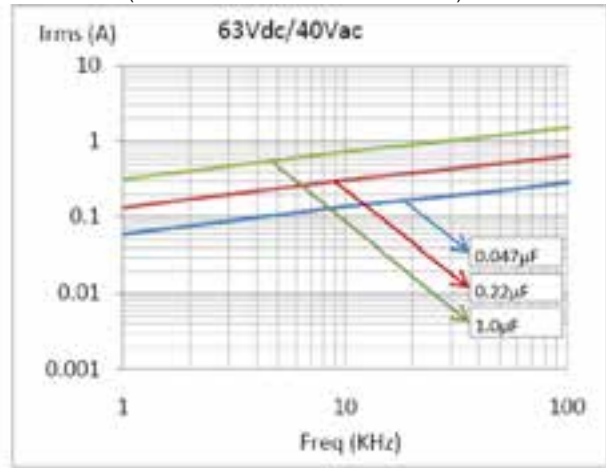

Max. Voltage (Vrms) vs. Frequency
(Sinusoidal Waveform at T ≤ 55° C)

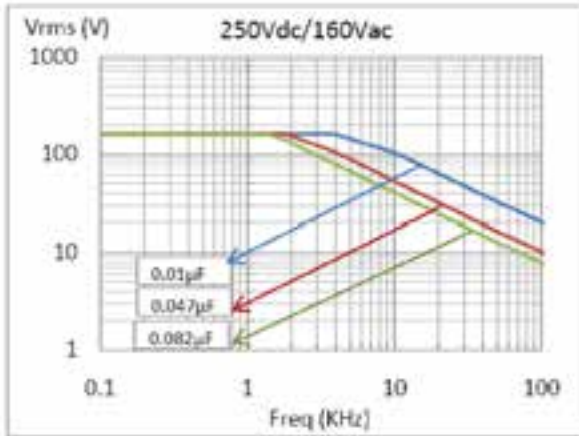

Max. Current (Irms) vs. Frequency
(Sinusoidal Waveform at T ≤ 55° C)

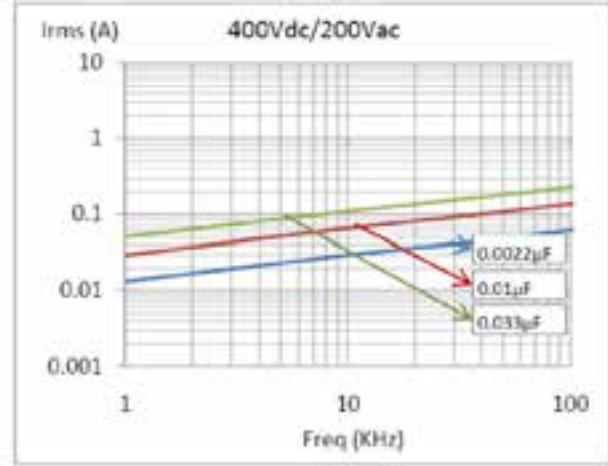
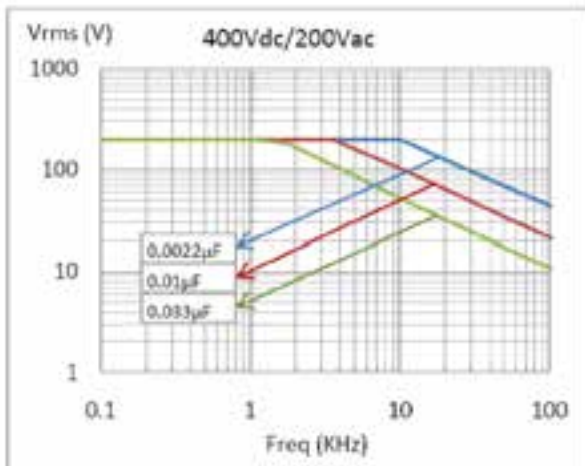
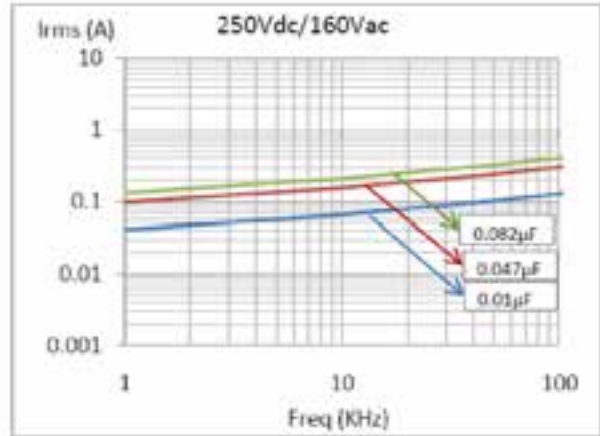

**Ordering code and packaging unit: Metallized polyester film capacitors
(Sub miniature Dip-Type) 5.0 mm pitch Series Code 14**

Rated Voltage	Rated Cap. (µF)	Dimensions (mm)						DV/DT V/µs	Wt. g	Ordering code	Packing units	
		W max.	H max.	L max.	d ±0.05	S ±0.75	F ±0.5				Ammo	Bulk
50 VDC	0.1	2.5	6.5	7.2	0.5	5	5	50	0.25	14 104 +1H*^	3000	4000
	0.33	3.5	8.5	7.2	0.5	5	5	50	0.35	14 334 +1H*^	2000	4000
	0.68	5.0	11.0	7.2	0.5	5	5	50	0.60	14 684 +1H*^	1500	2000
	1.0	6.0	11.0	7.2	0.5	5	5	50	0.60	14 105 +1H*^	1000	4000
63 VDC	0.01	2.5	6.5	7.2	0.5	5	5	60	0.25	14 103 +1J*^	3000	4000
	0.1	2.5	6.5	7.2	0.5	5	5	60	0.25	14 104 +1J*^	3000	4000
	0.47	5.0	11.0	7.2	0.5	5	5	60	0.60	14 474 +1J*^	1500	2000
	0.68	6.0	11.0	7.2	0.5	5	5	60	0.60	14 684 +1J*^	1000	2000
100 VDC	0.0015	2.5	6.5	7.2	0.5	5	5	110	0.25	14 152 +2A*^	3000	4000
	0.1	3.5	8.5	7.2	0.5	5	5	110	0.35	14 104 +2A*^	2000	4000
	0.33	6.0	11.0	7.2	0.5	5	5	110	0.60	14 334 +2A*^	1000	2000
250 VDC	0.0015	2.5	6.5	7.2	0.5	5	5	320	0.35	14 152 +2E*^	3000	4000
	0.01	3.0	6.5	7.2	0.5	5	5	320	0.35	14 103 +2E*^	2500	4000
	0.1	6.0	11.0	7.2	0.5	5	5	320	0.60	14 104 +2E*^	1000	2000
400 VDC	0.0015	2.5	6.5	7.2	0.5	5	5	600	0.35	14 152 +2G*^	3000	4000
	0.01	3.5	8.5	7.2	0.5	5	5	600	0.35	14 103 +2G*^	2000	4000
	0.033	5.0	11.0	7.2	0.5	5	5	600	0.60	14 333 +2G*^	1500	2000

**Ordering code and packaging unit: Metallized polyester film capacitors
(Sub miniature Box-Type) 5.5mm pitch Series Code 16**

Rated Voltage	Rated Cap. (µF)	Dimensions (mm)						DV/DT V/µs	Wt. g	Ordering code	Packing units	
		W ±0.5	H ±0.5	L ±0.5	d ±0.05	S ±0.5	F ±0.5				Ammo	Bulk
50 VDC	0.1	2.5	6.5	7.2	0.5	5	5	50	0.25	16 104 +1H [^]	3000	4000
	0.47	4.5	9.5	7.2	0.5	5	5	50	0.45	16 474 +1H [^]	1500	2000
	1	6.0	11.0	7.2	0.5	5	5	50	0.60	16 105 +1H [^]	1000	4000
63 VDC	0.047	2.5	6.5	7.2	0.5	5	5	60	0.25	16 473 +1J [^]	3000	4000
	0.1	2.5	6.5	7.2	0.5	5	5	60	0.25	16 104 +1J [^]	3000	4000
	0.68	6.0	11.0	7.2	0.5	5	5	60	0.60	16 684 +1J [^]	1000	2000
100 VDC	0.001	2.5	6.5	7.2	0.5	5	5	110	0.25	16 102 +2A [^]	3000	4000
	0.01	2.5	6.5	7.2	0.5	5	5	110	0.28	16 103 +2A [^]	2500	4000
	0.1	3.5	7.5	7.2	0.5	5	5	110	0.35	16 104 +2A [^]	2000	4000
	0.33	6.0	11.0	7.2	0.5	5	5	110	0.60	16 334 +2A [^]	1000	2000
250 VDC	0.001	2.5	6.5	7.2	0.5	5	5	320	0.35	16 102 +2E [^]	3000	4000
	0.01	2.5	6.5	7.2	0.5	5	5	320	0.35	16 103 +2E [^]	2500	4000
	0.1	6.0	11.0	7.2	0.5	5	5	320	0.60	16 104 +2E [^]	1000	2000
400 VDC	0.001	2.5	6.5	7.2	0.5	5	5	600	0.35	16 102 +2G [^]	3000	4000
	0.01	3.5	7.5	7.2	0.5	5	5	600	0.35	16 103 +2G [^]	2000	4000
	0.047	6.0	11.0	7.2	0.5	5	5	600	0.60	16 473 +2G [^]	1000	2000

**Derating graph for metallized polyester film capacitors
(Miniature) 7.5 mm pitch Series Code 13, 15**

Max. Voltage (Vrms) vs. Frequency
(Sinusoidal Waveform at T ≤ 55° C)

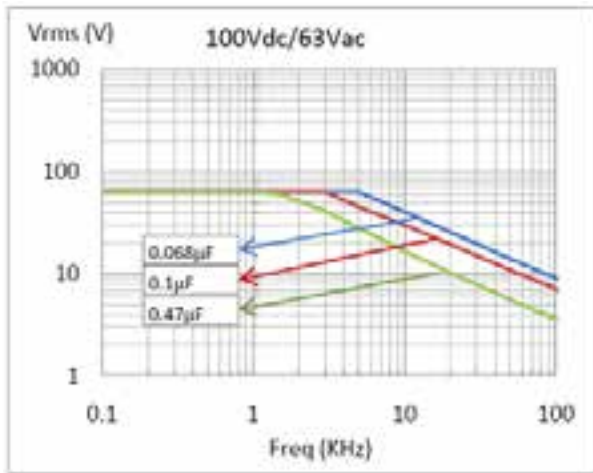

Max. Current (Irms) vs. Frequency
(Sinusoidal Waveform at T ≤ 55° C)

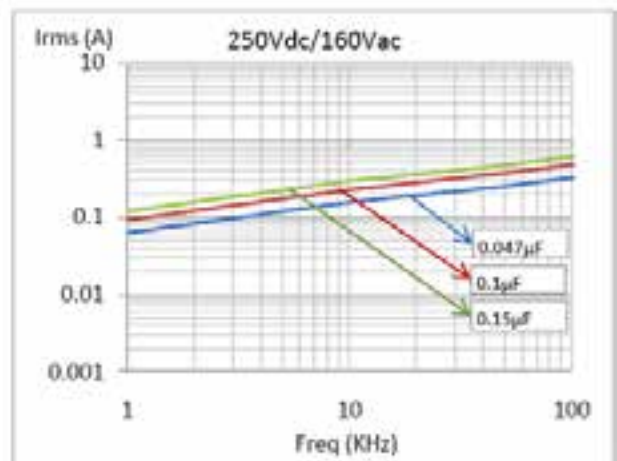
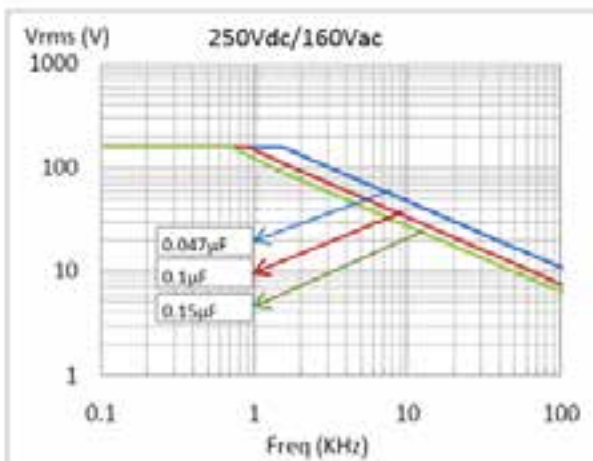
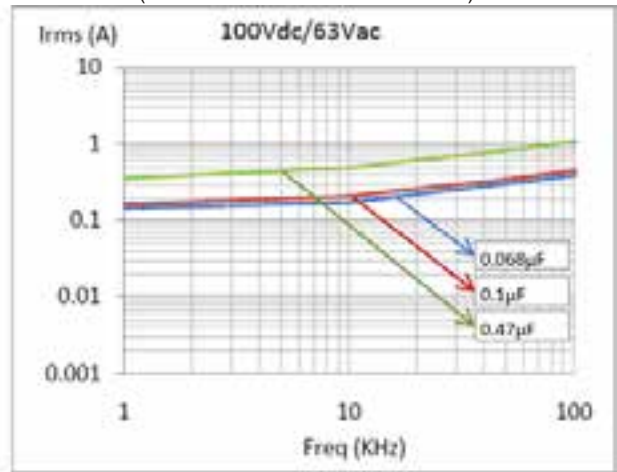

Max. Voltage (Vrms) vs. Frequency
(Sinusoidal Waveform at T ≤ 55° C)

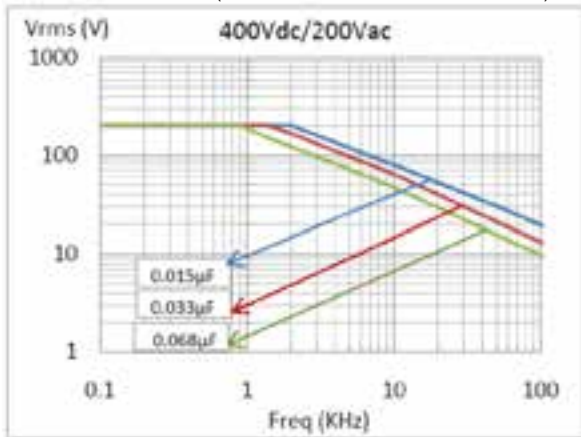

Max. Current (Irms) vs. Frequency
(Sinusoidal Waveform at T ≤ 55° C)

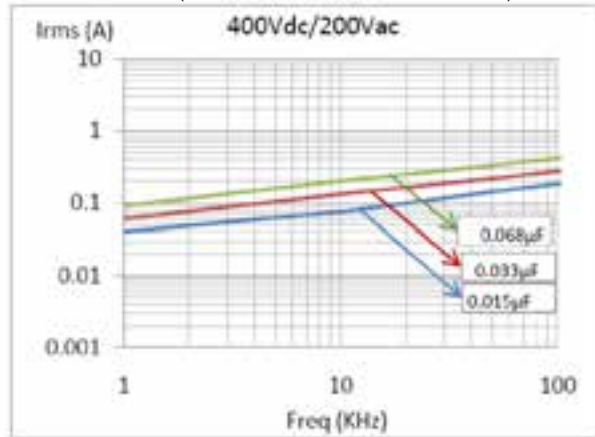

**Ordering code and packaging unit: Metallized polyester film capacitors
(Miniature - Dip Type) 7.5 mm pitch Series Code 13**

Rated Voltage	Rated Cap. (µF)	Dimensions (mm)						DV/DT V/µs	Wt. g	Ordering code	Packing units		
		W max.	H max.	L max.	d ±0.05	S ±0.75	F ±0.5				Ammo	Reel	Bulk
63 VDC	0.10	3.5	6.5	10.5	0.5	7.5	7.5	18	0.45	13 104 +1J*^	1500	1500	1000
	0.33	4.0	9.0	10.5	0.5	7.5	7.5	18	0.50	13 334 +1J*^	1500	1000	1000
	1.00	6.0	12.0	10.5	0.5	7.5	7.5	18	0.80	13 105 +1J*^	750	750	1000
100 VDC	0.033	3.5	6.5	10.5	0.5	7.5	7.5	36	0.45	13 333 +2A*^	1500	1500	1000
	0.1	5.0	10.0	10.5	0.5	7.5	7.5	36	0.50	13 104 +2A*^	1500	1000	1000
	0.47	5.5	11.0	10.5	0.5	7.5	7.5	36	0.90	13 474 +2A*^	750	750	1000
250 VDC	0.022	3.5	8.0	10.5	0.5	7.5	7.5	70	0.45	13 223 +2E*^	1500	1500	1000
	0.1	5.0	10.0	10.5	0.5	7.5	7.5	70	0.70	13 104 +2E*^	1500	1000	1000
	0.22	6.0	12.0	10.5	0.5	7.5	7.5	70	0.90	13 224 +2E*^	750	750	1000
400 VDC	0.022	4.5	10.0	10.5	0.5	7.5	7.5	190	0.50	13 223 +2G*^	1500	1000	1000
	0.047	5.5	11.0	10.5	0.5	7.5	7.5	190	0.70	13 473 +2G*^	1000	750	1000
	0.068	6.0	12.0	10.5	0.5	7.5	7.5	190	1.10	13 683 +2G*^	750	750	1000
630 VDC	0.0015	3.5	6.5	10.5	0.5	7.5	7.5	450	0.50	13 152 +2J*^	1500	1000	1000
	0.01	5.5	11.0	10.5	0.5	7.5	7.5	450	0.70	13 103 +2J*^	1000	1000	1000
	0.015	6.5	12.0	10.5	0.5	7.5	7.5	450	0.90	13 153 +2J*^	750	750	1000
	0.022	6.5	12.0	10.5	0.5	7.5	7.5	450	0.90	13 223 +2J*^	750	750	1000

**Ordering code and packaging unit: Metallized polyester film capacitors
(Miniature - Box Type) 7.5 mm pitch Series Code 15**

Rated Voltage	Rated Cap. (µF)	Dimensions (mm)						DV/DT V/µs	Wt. g	Ordering code	Packing units		
		W ±0.5	H ±0.5	L ±0.5	d ±0.05	S ±0.75	F ±0.5				Ammo	Reel	Bulk
63 VDC	0.1	3.5	6.5	10.5	0.5	7.5	7.5	18	0.45	15 104 +1J*^	1500	1500	1000
	0.47	5.0	11.0	10.5	0.5	7.5	7.5	18	0.70	15 474 +1J*^	1000	1000	1000
	0.68	5.0	11.0	10.5	0.5	7.5	7.5	18	0.70	15 684 +1J*^	1000	1000	1000
	1	6.0	12.0	10.5	0.5	7.5	7.5	18	0.80	15 105 +1J*^	750	750	1000
100 VDC	0.033	3.5	6.5	10.5	0.5	7.5	7.5	36	0.45	15 333 +2A*^	1500	1500	1000
	0.1	4.5	9.0	10.5	0.5	7.5	7.5	36	0.60	15 104 +2A*^	1500	1000	1000
	0.47	6.0	12.0	10.5	0.5	7.5	7.5	36	0.90	15 474 +2A*^	750	750	1000
250 VDC	0.01	3.5	6.5	10.5	0.5	7.5	7.5	70	0.50	15 103 +2E*^	1500	1500	1000
	0.1	4.0	9.0	10.5	0.5	7.5	7.5	70	0.70	15 104 +2E*^	1500	1000	1000
	0.22	6.0	12.0	10.5	0.5	7.5	7.5	70	0.90	15 224 +2E*^	750	750	1000
400 VDC	0.0047	3.5	6.5	10.5	0.5	7.5	7.5	190	0.45	15 472 +2G*^	1500	1500	1000
	0.01	4.0	9.0	10.5	0.5	7.5	7.5	190	0.60	15 103 +2G*^	1500	1000	1000
	0.068	6.0	12.0	10.5	0.5	7.5	7.5	190	0.90	15 683 +2G*^	750	750	1000
630 VDC	0.01	5.0	11.0	10.5	0.5	7.5	7.5	450	0.60	15 103 +2J*^	1000	1000	1000
	0.015	6.0	12.0	10.5	0.5	7.5	7.5	450	0.60	15 153 +2J*^	750	750	1000
	0.022	6.0	12.0	10.5	0.5	7.5	7.5	450	0.70	15 223 +2J*^	750	750	1000

**Derating graph for metallized polyester film capacitors
10-27.5 mm pitch Series Code 02, 06**

Max. Voltage (Vrms) vs. Frequency
(Sinusoidal Waveform at $T \leq 55^\circ C$)

Max. Current (Irms) vs. Frequency
(Sinusoidal Waveform at $T \leq 55^\circ C$)

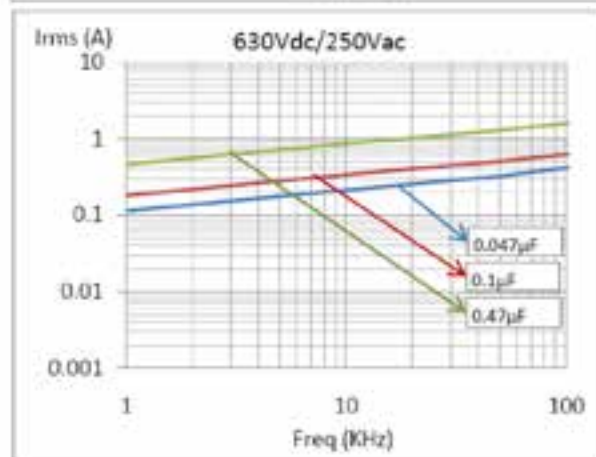
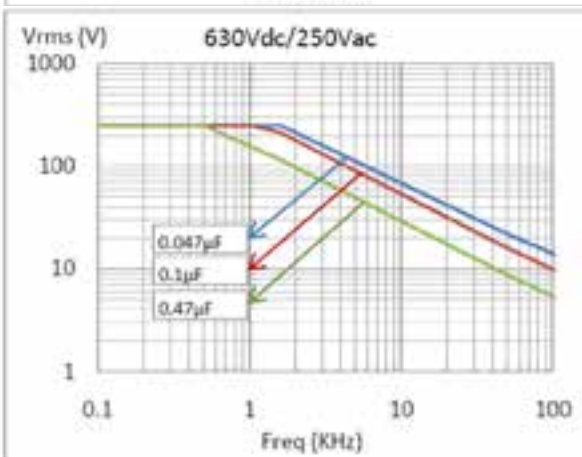
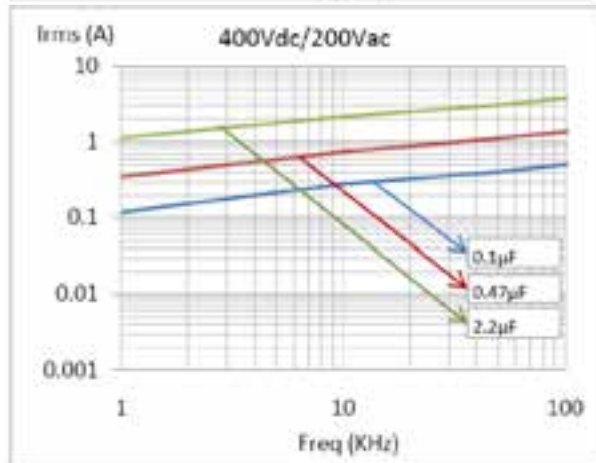
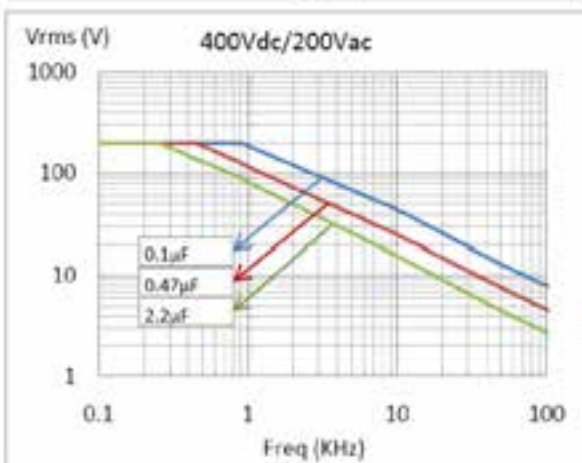
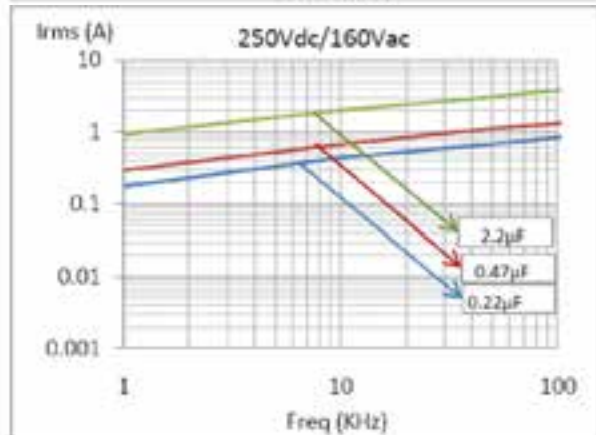
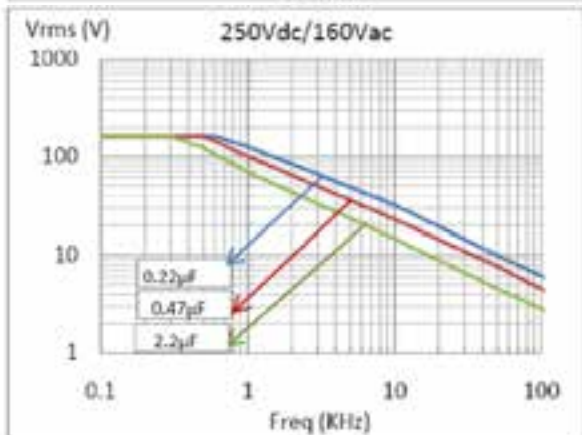
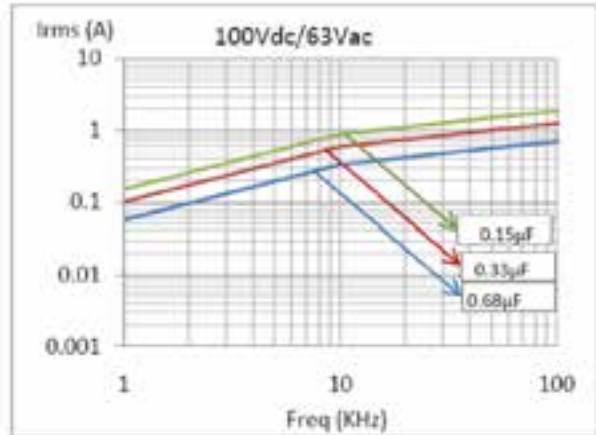
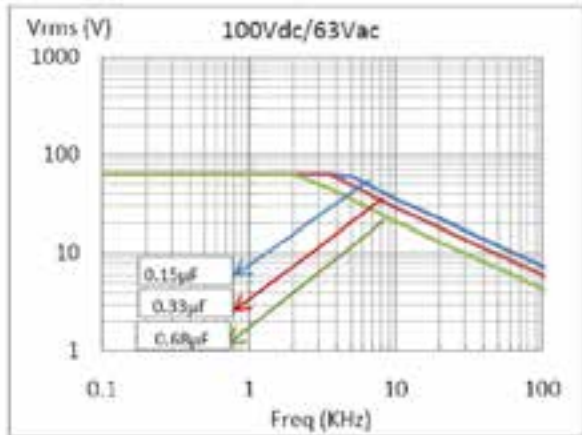

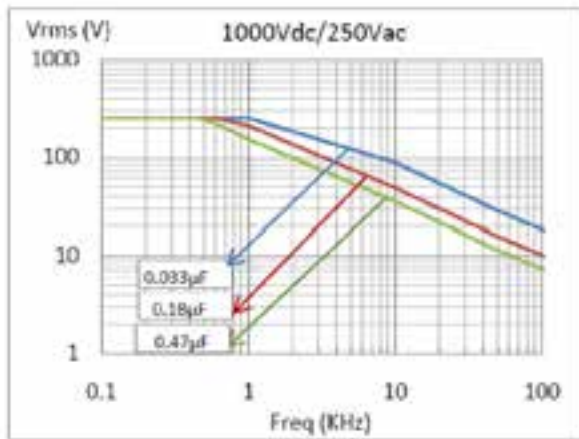
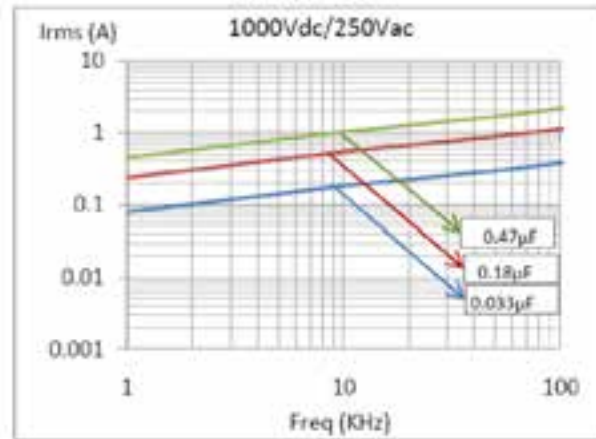
Max. Voltage (Vrms) vs. Frequency
 (Sinusoidal Waveform at $T \leq 55^\circ \text{C}$)

 Max. Current (Irms) vs. Frequency
 (Sinusoidal Waveform at $T \leq 55^\circ \text{C}$)

**Ordering code and packaging unit: Metallized polyester film capacitors
 (Dip Type) 10-27.5 mm pitch Series Code 02**

Rated Voltage	Rated Cap. (μF)	Dimensions (mm)						DV/DT $\text{V}/\mu\text{s}$	Wt. g	Ordering code	Packing units	
		W max.	H max.	L max.	d ± 0.05	S ± 0.75	F ± 0.5				Ammo	Bulk
100 VDC	0.1	4.0	9.0	13	0.6	10.0	10.0	28	0.60	02 104 +2A [^]	1500	1000
	1	9.0	15.0	19	0.8	15.0	15.0	20	1.30	02 105 +2A [^]	-	1000
	1.5	8.0	15.0	19	0.8	15.0	15.0	8	2.00	02 155 +2A [^]	-	1000
	4.7	8.5	18.0	27	0.8	22.5	-	7	5.20	02 475 +2A [^]	-	500
	10.0	12.0	19.0	31	0.8	27.5	-	5	8.50	02 106 +2A [^]	-	250
250 VDC	0.027	4.0	9.0	13	0.6	10.0	10.0	70	0.65	02 273 +2E [^]	1500	1000
	0.1	6.0	12.0	13	0.6	10.0	10.0	70	0.75	02 104 +2E [^]	1500	1000
	0.47	7.0	13.0	19	0.8	15.0	15.0	28	2.10	02 474 +2E [^]	-	1000
	1	7.0	16.5	27	0.8	22.5	22.5	12	3.60	02 105 +2E [^]	-	500
	2.2	9.5	19.5	27	0.8	22.5	-	12	6.50	02 225 +2E [^]	-	250
400 VDC	3.3	12	21.0	27	0.8	22.5	-	12	7.50	02 335 +2E [^]	-	250
	0.01	4.0	9.0	13	0.6	10.0	10.0	110	0.60	02 103 +2G [^]	1500	1000
	0.1	6.0	12.5	19	0.8	15.0	15.0	44	1.00	02 104 +2G [^]	-	1000
	0.68	8.0	15.0	27	0.8	22.5	-	20	3.50	02 564 +2G [^]	-	500
	1	7.0	16.0	31	0.8	27.5	-	16	4.00	02 105 +2G [^]	-	250
	1.5	10.0	19.0	31	0.8	27.5	-	16	5.00	02 155 +2G [^]	-	250
630 VDC	2.2	10.3	19.0	31	0.8	27.5	-	16	6.87	02 225 +2G [^]	-	250
	3.3	14.0	21.5	31	0.8	27.5	-	16	9.50	02 335 +2G [^]	-	250
	0.01	5.0	12.0	13	0.6	10.0	10.0	70	0.65	02 103 +2J [^]	1500	1000
	0.1	8.0	16.0	19	0.8	15.0	15.0	70	2.00	02 104 +2J [^]	-	1000
	0.47	12.0	21.0	32	0.8	27.5	-	24	6.50	02 474 +2J [^]	-	250
1000 VDC	1	17.0	29.0	31	0.8	27.5	-	24	9.50	02 105 +2J [^]	-	250
	0.18	10.0	22.5	31	0.8	27.5	-	35	-	02 184 + 3A [^]	-	250
	0.47	16.0	24.0	31	0.8	27.5	-	35	-	02 474 + 3A [^]	-	250

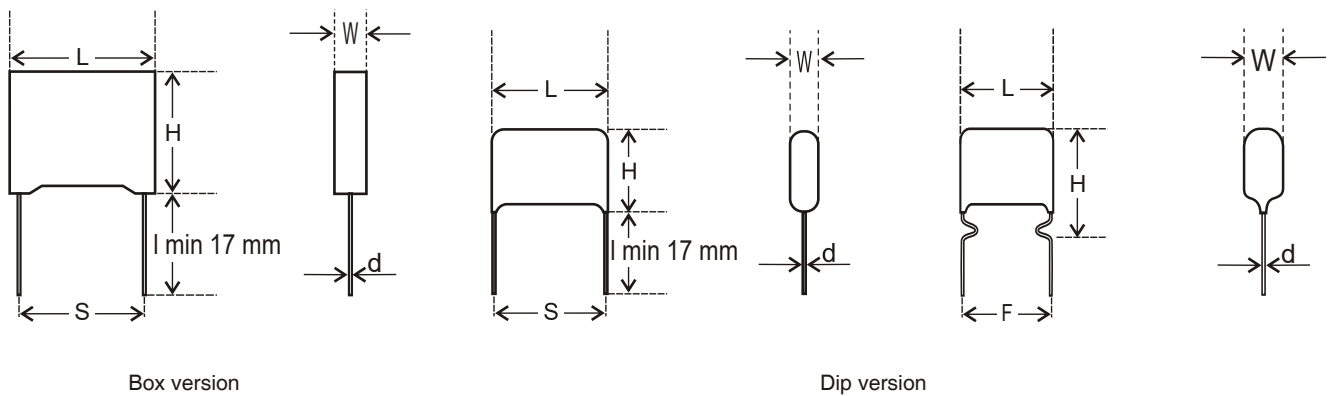
**Ordering code and packaging unit: Metallized polyester film capacitors
(Box Type) 10-27.5 mm pitch Series Code 06**

Rated Voltage	Rated Cap. (μF)	Dimensions (mm)					S ±0.75	F ±0.5	DV/DT V/μs	Wt. g	Ordering code	Packing units Bulk
		W ±0.5	H ±0.5	L ±0.5	d ±0.05							
100 VDC	0.056	4.0	9.0	13.0	0.6	10.0	10.0	28	0.4	06 563 +2A*^	1000	
	0.47	5.5	11.5	19.0	0.8	15.0	15.0	20	0.7	06 474 +2A*^	1000	
	1	7.5	13.5	19.0	0.8	15.0	15.0	20	1.3	06 105 +2A*^	1000	
	4.7	9.5	18.5	32.0	0.8	27.5	-	7	5.2	06 475 +2A*^	500	
	6.8	11.5	20.5	32.0	0.8	27.5	-	7	6.5	06 685 +2A*^	250	
250 VDC	0.027	4.0	9.0	13.0	0.6	10.0	10.0	70	0.4	06 273 +2E*^	1000	
	0.1	5.0	10.0	13.0	0.6	10.0	10.0	70	0.5	06 104 +2E*^	1000	
	0.47	5.5	14.5	27.0	0.8	22.5	22.5	12	2.1	06 474 +2E*^	1000	
	1	7.5	17.0	26.5	0.8	22.5	22.5	12	3.6	06 105 +2E*^	500	
	2.2	10.5	19.5	32.0	0.8	27.5	-	10	6.4	06 224 +2E*^	250	
400 VDC	0.01	4.0	9.0	13.0	0.6	10.0	10.0	110	0.4	06 103 +2G*^	1000	
	0.1	6.0	12.0	18.0	0.8	15.0	15.0	44	0.9	06 104 +2G*^	1000	
	0.47	7.5	16.5	27.0	0.8	22.5	22.5	20	3.4	06 474 +2G*^	500	
	1	10.0	19.0	32.0	0.8	27.5	-	16	5.0	06 105 +2G*^	250	
630 VDC	0.01	5.0	11.0	13.0	0.6	10.0	10.0	70	0.4	06 103 +2J*^	1000	
	0.047	7.0	13.0	19.0	0.8	15.0	15.0	70	1.2	06 473 +2J*^	1000	
	0.1	6.0	15.0	27.0	0.8	22.5	22.5	28	2.1	06 104 +2J*^	1000	
	0.47	12.0	21.0	32.0	0.8	27.5	-	24	6.5	06 474 +2J*^	250	



Plain Polyester Axial Film Capacitors

Series Code
131

Non-Inductive (Tape Wrapped)

Main Application

Blocking, bypassing, filtering, coupling and decoupling, interference suppression in low voltage application, low pulse application.

Construction

Film/foil inductive type construction with aluminum foil as electrode and polyester film as dielectric wrapped in polyester tape filled with epoxy resin.

Climatic Category

40/105/21

Rated and Maximum Operating Temperature

85°C and 105°C

Applicable Specification

IEC 384-11

Capacitance Value

0.001µF- 1.0 µF

Rated Voltage

100VDC-1250VDC

Capacitance Tolerance

±5%, ±10%

Voltage Proof

Between terminals: 2 times of rated voltage for 2 sec.

Tan δ

0.8% (maximum) at 1 kHz.

Life Test Conditions

(Loading at elevated temperature)

Loaded at 1.5 times of rated voltage at 85° C for 1000 hours.

After the Test

$\Delta C/C$: ≤ 10% of initial value.

Increase of Tan δ: ≤ 0.004 times the value measured before the test.

Insulation resistance: ≥ 50% of the value mentioned in IR chart.

Insulation Resistance

Minimum Insulation Resistance R_{IS}
(or) time constant = $C_R \times R_{IS}$

at 25° C, relative humidity ≤70%

$C_R \leq 0.33\mu F$
30000 MΩ

$C_R > 0.33\mu F$
10000 s

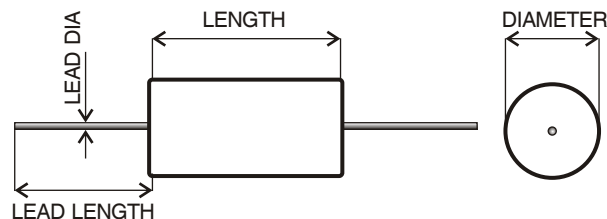

Metallized Polyester Axial Film Capacitors

Series Code
12, 36

MPET-Axial

Main Application

Blocking, bypassing, filtering, timing, coupling and decoupling low pulse operations.

Construction

Low inductive cell of metallized polyester film wrapped with polyester tape filled by resin.

Climatic Category

40/100/21

Maximum Operating Temperature

100°C

Applicable Specification

IEC 384-2

Capacitance Value

0.01µF - 15.0µF

Capacitance Tolerance

±5%, ±10%

Insulation Resistance

Minimum Insulation Resistance R_{is} V_R $C_R \leq 0.33\mu F$ $C_R > 0.33\mu F$
 (or) time constant = $C_R \times R_{is}$ ≤ 100 V DC 3750 MΩ 1250 s
 at 25° C, relative humidity $\leq 70\%$ > 100 V DC 7500 MΩ 2500 s

Rated Voltage

100VDC-630VDC

Voltage Proof

Between terminals: 1.6 times of rated voltage for 2 sec.

Tan δ

Frequency	$C_R < 0.1\mu F$	$0.1\mu F \leq C_R \leq 1\mu F$	$C_R > 1\mu F$
1kHz	0.8%	1.0%	1.0%
10kHz	1.5%	1.5%	-

Life Test Conditions

(Loading at elevated temperature)

Loaded at 1.25 times of rated voltage at 85°C for 1000 hours.

After the Test:

$\Delta C/C$: $\leq 5\%$ of initial value.

Increase of Tan δ: ≤ 0.005 , $C_R \leq 1\mu F$; ≤ 0.003 , $C_R > 1\mu F$

Insulation resistance: $\geq 50\%$ of the value mentioned in IR chart.

Ordering code and packing units: Metallized Polyester Round Axial Film Capacitors Series Code 12

Rated Voltage	Rated Cap. (µF)	Dimensions (mm)			Lead Length (Min)	Weight g	Ordering Code	Packing Units Bulk
		Outer Diameter (Max)	Length (Max)	Lead Diameter (±0.05)				
100VDC	0.033	10.0	15	0.6	30	2.1	12 333 + 2A ^A	500
	0.100	10.5	15	0.6	30	2.4	12 104 + 2A ^A	500
	1.000	14.5	15	0.6	30	4.7	12 105 + 2A ^A	250
	1.500	15.5	21	0.8	30	6.9	12 155 + 2A ^A	250
	2.200	16.5	21	0.8	30	7.1	12 225 + 2A ^A	250
	4.700	20.0	29	0.8	30	14.5	12 475 + 2A ^A	200
250VDC	6.800	21.0	35	0.8	30	19.0	12 685 + 2A ^A	200
	0.033	10.0	15	0.6	30	2.1	12 333 + 2E ^A	500
	0.100	10.5	15	0.6	30	2.4	12 104 + 2E ^A	500
	1.000	14.5	15	0.6	30	4.7	12 105 + 2E ^A	250
	4.700	18.0	35	0.8	30	13.7	12 475 + 2E ^A	100
	9.000	23.0	35	0.8	30	27.0	12 905 + 2E ^A	100
400VDC	0.033	10.0	15	0.6	30	2.1	12 333 + 2G ^A	500
	0.100	10.5	15	0.6	30	2.4	12 104 + 2G ^A	500
	0.470	12.0	29	0.8	30	4.8	12 474 + 2G ^A	250
	1.000	15.5	29	0.8	30	8.6	12 105 + 2G ^A	200
	2.200	19.5	35	0.8	30	16.0	12 225 + 2G ^A	100
	3.300	23.0	35	0.8	30	22.8	12 335 + 2G ^A	100
	10.000	27.5	45	1.0	30	43.0	12 106 + 2G ^A	50
630VDC	15.000	31.0	45	1.0	30	52.0	12 156 + 2G ^A	50
	0.033	10.0	15	0.6	30	2.5	12 333 + 2J ^A	250
	0.100	14.0	15	0.6	30	5.0	12 104 + 2J ^A	250
	0.470	17.0	29	0.8	30	9.0	12 474 + 2J ^A	250
	1.000	21.5	29	0.8	30	17.1	12 105 + 2J ^A	200
	1.500	19.5	45	1.0	30	21.1	12 155 + 2J ^A	100
2.200	23.0	45	1.0	30	29.5	12 225 + 2J ^A	100	

Ordering code and packing units: Metallized Polyester Flat Axial Film Capacitors Series Code 36

Rated Voltage	Rated Cap. (µF)	Dimensions (mm)				Lead Diameter (±0.05)	Lead Length (Min)	Weight g	Ordering Code	Packing Units Bulk
		W (Max)	H (Max)	L (Max)	Lead Diameter					
100VDC	0.010	5.5	8.5	15	0.6	30	1.3	36 103 + 2A ^A	500	
	0.047	6.0	10.0	15	0.6	30	1.8	36 473 + 2A ^A	500	
	0.100	6.5	10.5	15	0.6	30	1.9	36 104 + 2A ^A	500	
	0.410	6.5	11.0	21	0.8	30	2.0	36 414 + 2A ^A	500	
	1.000	8.5	13.5	21	0.8	30	3.4	36 105 + 2A ^A	200	
	4.700	11.5	19.5	35	0.8	30	6.3	36 475 + 2A ^A	200	
	6.800	14.5	23.0	35	0.8	30	8.5	36 685 + 2A ^A	200	
	10.000	14.5	23.0	45	1.0	30	14.0	36 106 + 2A ^A	50	
250VDC	0.010	5.5	8.5	15	0.6	30	1.3	36 103 + 2E ^A	500	
	0.047	6.0	10.0	15	0.6	30	1.8	36 473 + 2E ^A	250	
	0.100	6.5	10.5	15	0.6	30	1.9	36 104 + 2E ^A	250	
	0.410	7.5	12.0	15	0.6	30	2.7	36 414 + 2E ^A	250	
	1.000	8.5	13.5	21	0.8	30	3.4	36 105 + 2E ^A	200	
	2.200	9.5	16.5	29	0.8	30	4.1	36 225 + 2E ^A	200	
	4.700	11.5	19.5	35	0.8	30	6.3	36 475 + 2E ^A	200	
	6.800	14.5	23.0	35	0.8	30	8.5	36 685 + 2E ^A	100	
400VDC	0.010	5.5	8.5	15	0.6	30	1.3	36 103 + 2G ^A	500	
	0.047	6.0	10.0	15	0.6	30	1.8	36 473 + 2G ^A	500	
	0.100	6.5	10.5	15	0.6	30	2.0	36 104 + 2G ^A	500	
	1.000	8.5	15.0	29	0.8	30	3.8	36 105 + 2G ^A	200	
	2.200	12.0	20.0	29	0.8	30	7.0	36 225 + 2G ^A	100	
	4.700	16.0	24.0	35	0.8	30	15.5	36 475 + 2G ^A	100	
	10.000	19.5	29.0	45	1.0	30	21.7	36 106 + 2G ^A	50	
	15.000	24.0	34.0	45	1.0	30	29.0	36 156 + 2G ^A	50	
630VDC	0.010	5.5	8.5	15	0.6	30	1.3	36 103 + 2J ^A	500	
	0.047	7.0	11.0	15	0.6	30	2.4	36 473 + 2J ^A	500	
	0.100	7.5	11.0	21	0.8	30	2.5	36 104 + 2J ^A	200	
	0.470	11.0	16.0	29	0.8	30	5.0	36 474 + 2J ^A	200	
	1.000	15.5	22.5	29	0.8	30	9.4	36 105 + 2J ^A	200	
	1.500	13.0	21.0	45	1.0	30	8.5	36 155 + 2J ^A	100	
	2.200	16.0	24.5	45	1.0	30	15.0	36 225 + 2J ^A	100	

Metallized Polyester Round Axial Film Capacitors - Series Code 12

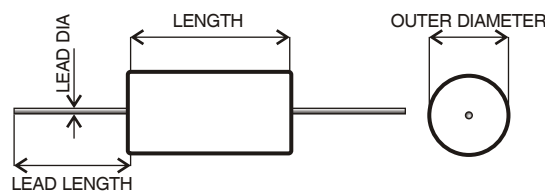

Metallized Polyester Flat Axial Film Capacitors - Series Code 36

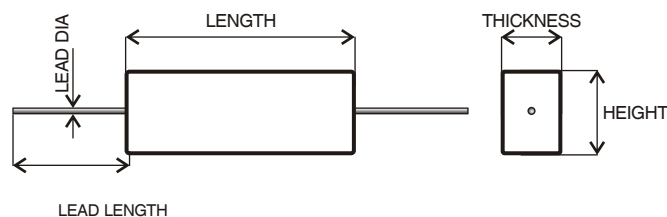

Fuse Type Metallized Polyester Film Capacitors

Series Code
88

MPET-F

Main Application

Smoothing in active power factor correction, LED driver, boost PFC, fly back PFC.

Construction

Low inductive cell of metallized polyester film with internal fuses coated with flame retardant epoxy resin.

Climatic Category

40/105/56

Rated and Maximum Operating Temperature

85°C and 105°C

Capacitance Value

0.047µF- 3.3µF

Capacitance Tolerance

±5%, ±10%

Rated Voltage

450VDC-630VDC

Insulation Resistance

Minimum Insulation Resistance R_{is}
at 25° C, relative humidity ≤ 70%

V_R
> 100 V DC

$C_R \leq 0.33\mu F$
7500 MΩ

$C_R > 0.33 \mu F$
2500s

Voltage Proof

Between terminals: 1.6 times of rated voltage for 2 sec.

Tan δ

Frequency	$C_R < 0.1\mu F$	$0.1\mu F \leq C_R \leq 1\mu F$	$C_R > 1\mu F$
1kHz	0.8%	0.8%	1.0%
10kHz	1.5%	1.5%	-
100kHz	3.0%	3.0%	-

Life Test Conditions

(Loading at elevated temperature)

Loaded at 1.25 times of rated voltage at 85° C for 1000 hours.

After the Test

$\Delta C/C: \leq 10\%$

Increase of Tan δ: $\leq 0.005, C_R \leq 1\mu F;$
 $\leq 0.003, C_R > 1\mu F;$

Insulation resistance: $\geq 50\%$ of the value mentioned in IR chart.

Ordering code and packing units: Fuse Type Metallized Polyester Film Capacitors (MPET-F) Dip Type Series Code 88

Rated Voltage	Rated Capacitance (µF)	W (max)	H (max)	Dimensions (mm)			S ±0.75	Wt. g	Ordering code
				L (max)	d ±0.05				
450VDC	0.047	6	11	13	0.6	10.0	0.9	88 473 + 2l *^	
	0.068	7	12	13	0.6	10.0	1.1	88 683 + 2l *^	
	0.1	7	11	13	0.6	10.0	1.1	88 104 + 2l *^	
	0.1	6	11	19	0.8	15.0	1.2	88 104 + 2l *^	
	0.22	6	10	19	0.8	15.0	1.2	88 224 + 2l *^	
	0.41	7	13	19	0.8	15.0	1.7	88 414 + 2l *^	
	0.68	8	15	19	0.8	15.0	2.6	88 684 + 2l *^	
	1.0	9	17	19	0.8	15.0	3.5	88 105 + 2l *^	
	0.47	6	13	27	0.8	22.5	1.9	88 474 + 2l *^	
	1.0	7	16	27	0.8	22.5	3.2	88 105 + 2l *^	
	1.5	9	17	27	0.8	22.5	4.5	88 155 + 2l *^	
	2.2	10	19	27	0.8	22.5	6.1	88 225 + 2l *^	
	0.33	7	12	31	0.8	27.5	2.5	88 334 + 2l *^	
	0.47	8	13	31	0.8	27.5	3.3	88 474 + 2l *^	
	0.68	6	12	31	0.8	27.5	2.4	88 684 + 2l *^	
	1.0	7	13	31	0.8	27.5	3.1	88 105 + 2l *^	
3.3	11	20	31	0.8	27.5	8.3	88 335 + 2l *^		
4.7	13	22	31	0.8	27.5	11.2	88 475 + 2l *^		

**Ordering code and packing units: Fuse Type Metallized Polyester Film Capacitors
(MPET-F) Dip Type Series Code 88**

Rated Voltage	Rated Capacitance (μF)	W (max)	H (max)	Dimensions (mm)			Wt. g	Ordering code
				L (max)	d ±0.05	S ±0.75		
630VDC	0.047	6	11	13	0.6	10.0	0.9	88 473 + 2J ^A
	0.068	7	12	13	0.6	10.0	1.1	88 683 + 2J ^A
	0.1	8	13	13	0.6	10.0	1.6	88 104 + 2J ^A
	0.1	6	11	19	0.8	15.0	1.3	88 104 + 2J ^A
	0.22	8	13	19	0.8	15.0	2.2	88 224 + 2J ^A
	0.41	10	16	19	0.8	15.0	3.7	88 414 + 2J ^A
	0.41	8	13	27	0.8	22.5	3.2	88 474 + 2J ^A
	0.68	9	17	27	0.8	22.5	4.7	88 684 + 2J ^A
	1.0	11	18	27	0.8	22.5	6.6	88 105 + 2J ^A
	0.33	7	12	31	0.8	27.5	2.6	88 334 + 2J ^A
	0.47	8	13	31	0.8	27.5	3.4	88 474 + 2J ^A
	0.68	8	16	31	0.8	27.5	4.6	88 684 + 2J ^A
	1.0	10	17	31	0.8	27.5	6.2	88 105 + 2J ^A
	1.5	11	20	31	0.8	27.5	8.7	88 155 + 2J ^A
	2.2	14	23	31	0.8	27.5	12.1	88 225 + 2J ^A
	3.3	18	27	31	0.8	27.5	17.4	88 335 + 2J ^A

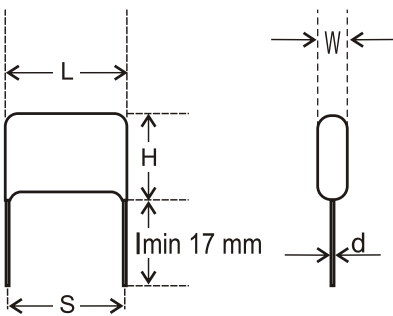

Plain Polypropylene Film Capacitors

Series Code
03

Inductive

Main Application

Oscillator, timing and LC/RC filter circuits, high frequency coupling of fast digital and analog ICs.

Construction

Film/foil inductive type construction with aluminum foil as electrode and PP film as dielectric coated epoxy resin.

Climatic Category

40/100/56

Rated and Maximum Operating Temperature

85°C and 100°C

Applicable Specification

IEC 384-13

Capacitance Value

0.0001µF-0.1 µF

Capacitance Tolerance

±5%, ±10%

Rated Voltage

100VDC-2000VDC

Insulation Resistance

Minimum Insulation Resistance R_{IS}
(or) time constant $T = C_R \times R_{IS}$
(at 100V DC for $100 < V_R < 500V$,
and 500VDC for $V_R > 500V$
temp 20°C, relative humidity ≤70%)

V_R
≤100 V DC
≥250 V DC

$C_R \leq 0.1 \mu F$
100 GΩ
100 GΩ

$C_R > 0.1 \mu F$
10000
10000

Voltage Proof

Between terminals 2 times of rated voltage for 2 sec.

Tan δ

0.08% (maximum) at 1 kHz.

Life Test Conditions

(Loading at elevated temperature)

Loaded at 1.5 times of rated voltage at 85° C or 1.5 times of category voltage. At 100° C for 1000 hours Category voltage is 80% of rated voltage.

After the Test

$\Delta C/C \leq 5\%$ of initial value.

Change in Tan δ: ≤ 1.4 times the value measured before the test, whichever is higher.

Insulation resistance: ≥ 50% of the value mentioned in IR chart.

Derating graph for Plain Polypropylene Film Capacitors Inductive

Max. Voltage (Vrms) vs. Frequency
(Sinusoidal Waveform at T ≤ 85° C)

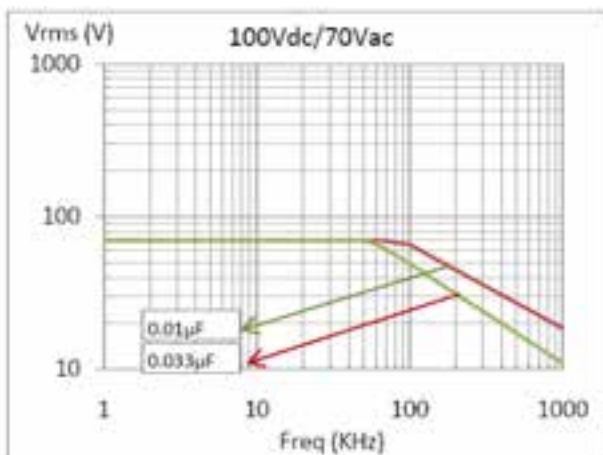

Max. Current (Irms) vs. Frequency
(Sinusoidal Waveform at T ≤ 85° C)

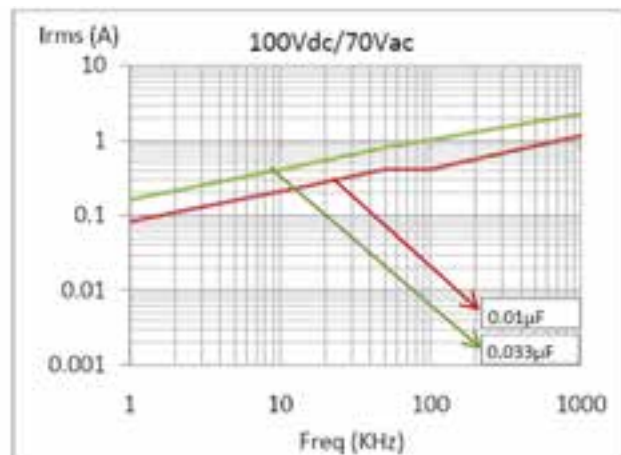

Max. Voltage (Vrms) vs. Frequency
(Sinusoidal Waveform at $T \leq 85^\circ\text{C}$)

Max. Current (Irms) vs. Frequency
(Sinusoidal Waveform at $T \leq 85^\circ\text{C}$)

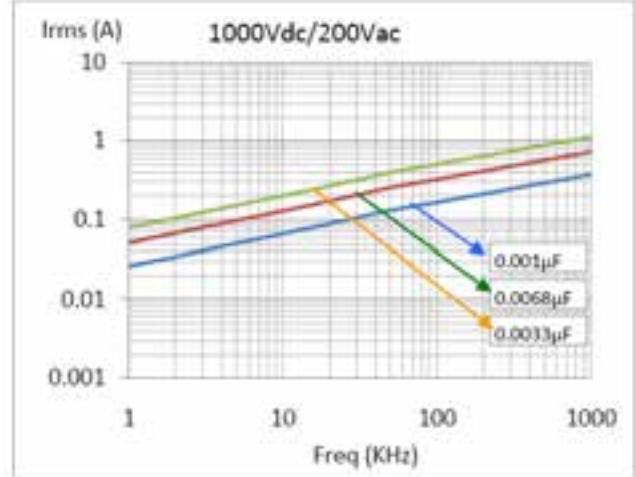
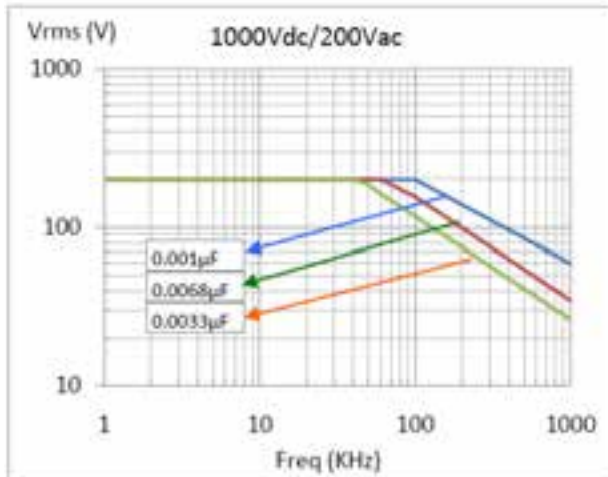
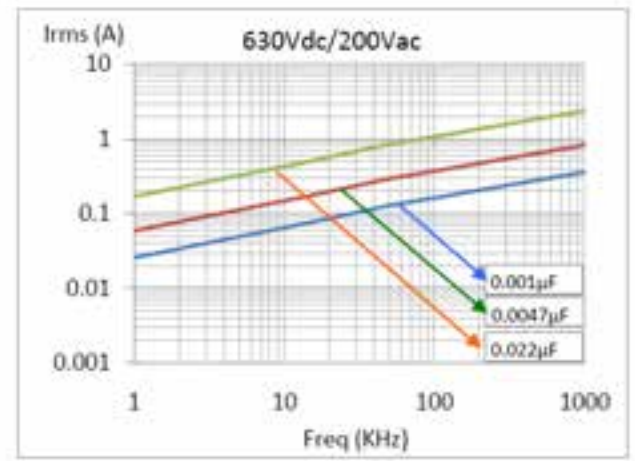
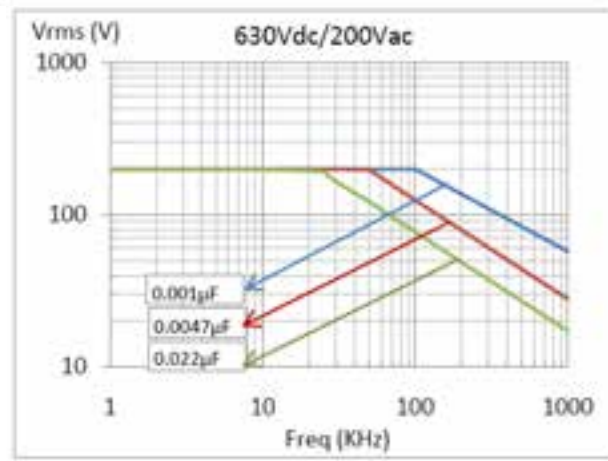
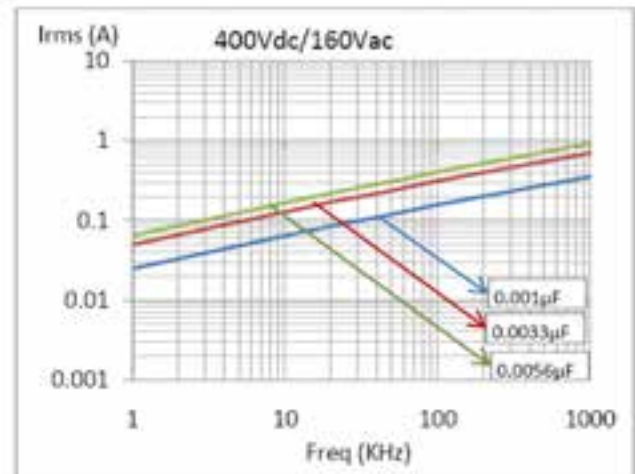
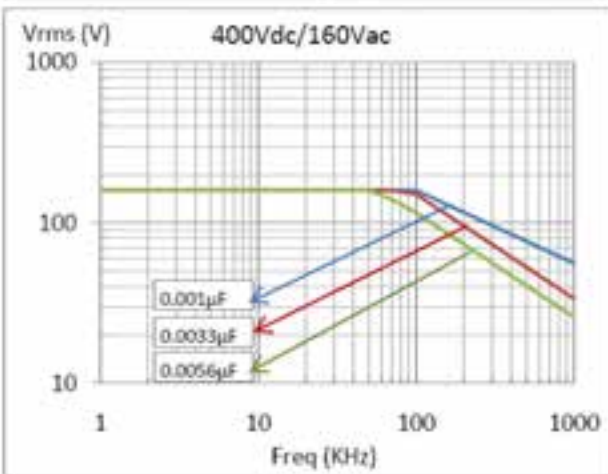
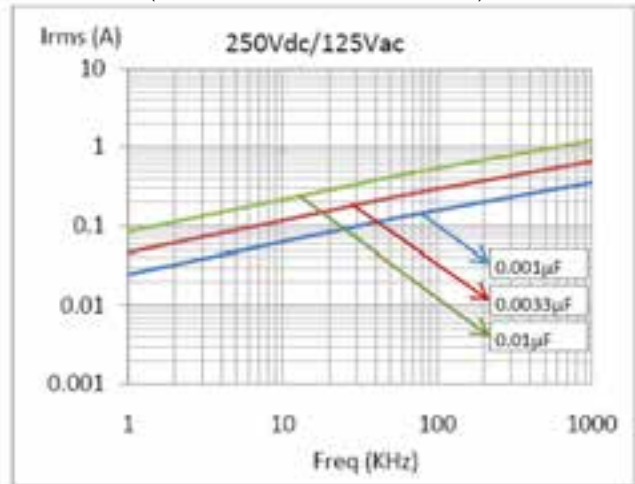
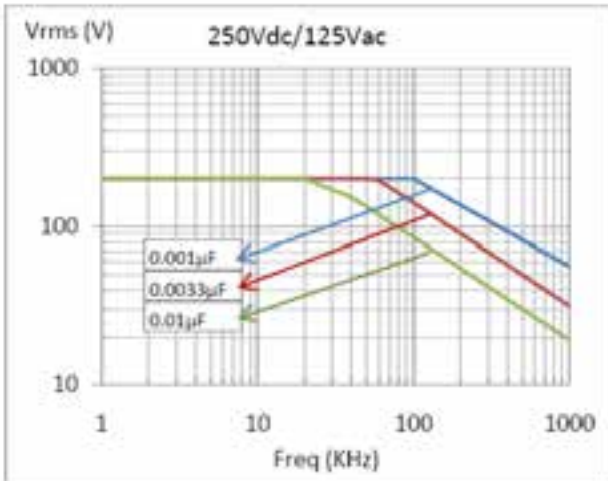

Max. Voltage (Vrms) vs. Frequency
(Sinusoidal Waveform at $T \leq 85^\circ\text{C}$)

Max. Current (Irms) vs. Frequency
(Sinusoidal Waveform at $T \leq 85^\circ\text{C}$)

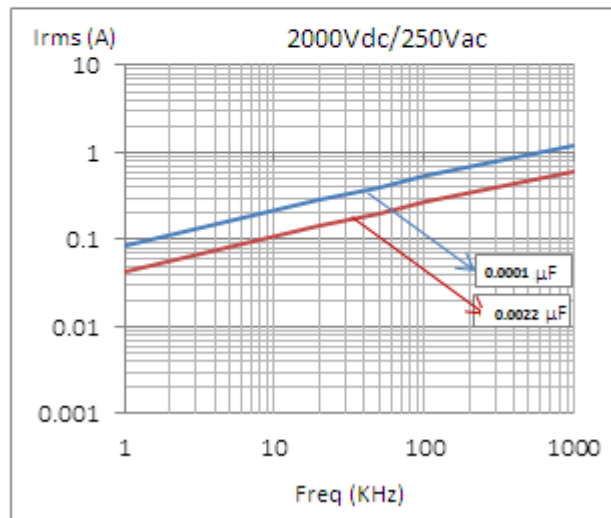
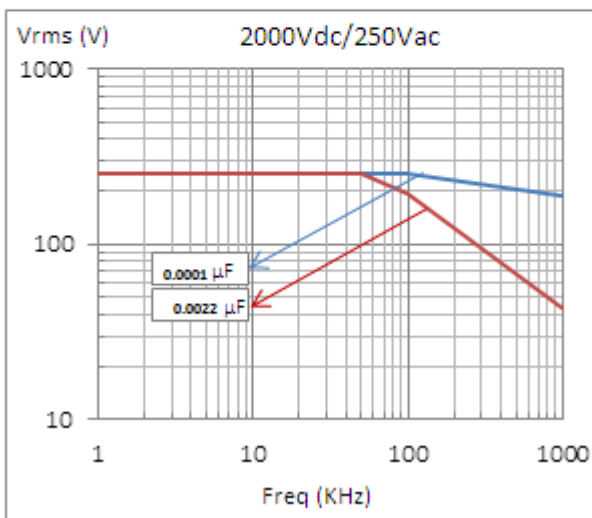
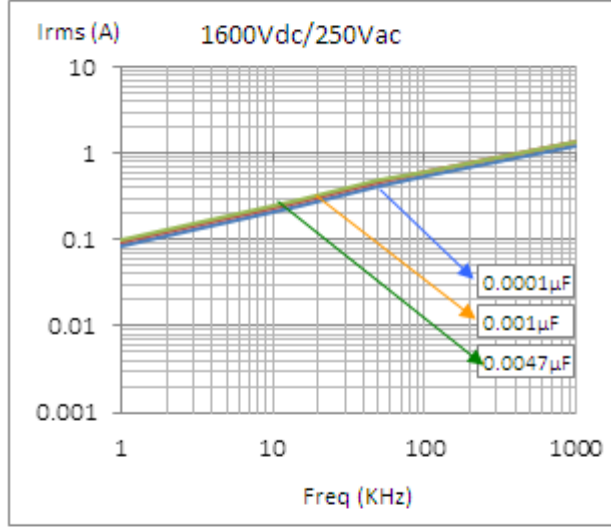
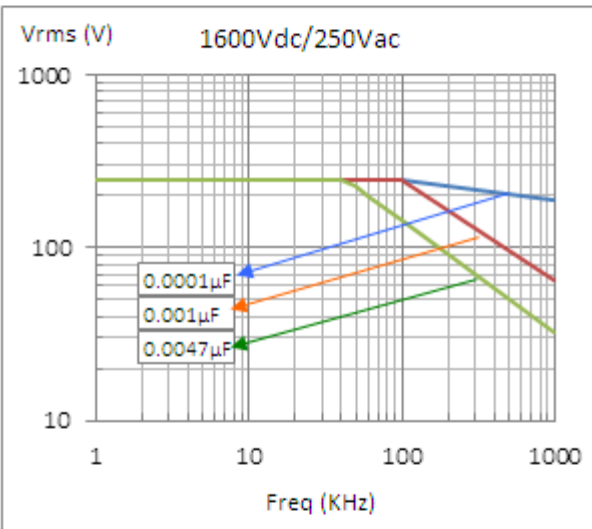
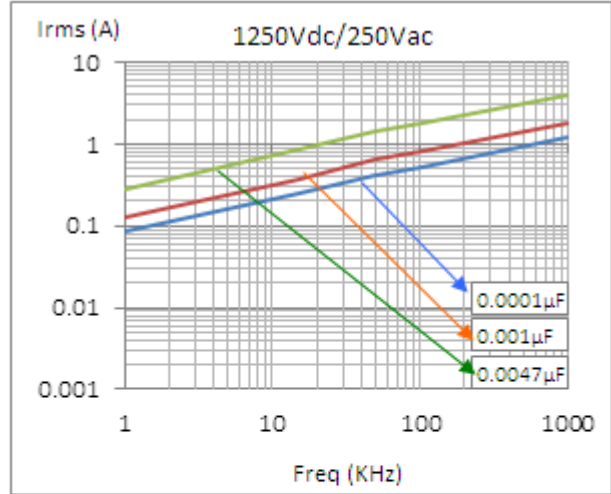
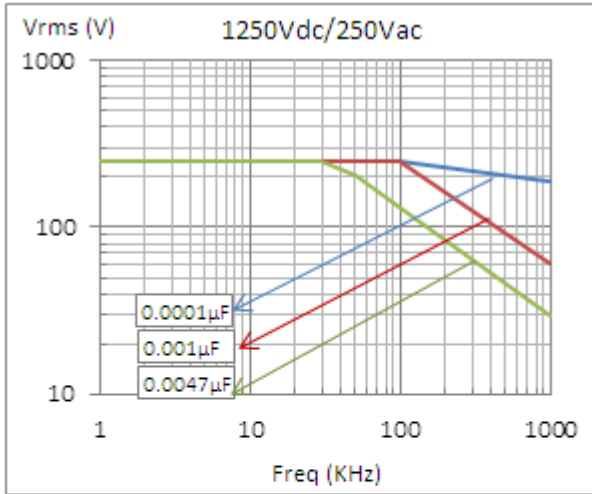

**Ordering code and packaging unit: Plain Polypropylene Film Capacitors
Inductive Series Code 03**

Rated Voltage	Rated Cap. (µF)	Dimensions (mm)						DV/DT V/µs	Wt. g	Ordering code	Packing units	
		W max.	H max.	L max.	d ±0.05	S ±0.75	F ±0.5				Ammo	Bulk
100 VDC	0.0001	9.0	15.0	6.0	0.5	5.0	5	10000	0.50	03 101 +2A*^	4000	2000
	0.001	6.5	12.0	4.0	0.5	4.0	5	10000	0.22	03 102 +2A*^	4500	2000
	0.01	7.5	12.0	4.5	0.5	5.0	5	10000	0.30	03 103 +2A*^	4500	2000
	0.1	11.5	14.0	7.0	0.5	7.5		10000	0.95	03 104 +2A*^	2000	1000
250 VDC	0.0001	9.0	15.0	6.0	0.5	5.0	5	10000	0.50	03 101 +2E*^	4000	2000
	0.001	6.5	12.0	4.0	0.5	4.0	5	10000	0.22	03 102 +2E*^	4500	2000
	0.0047	7.0	12.0	4.5	0.5	4.5	5	10000	0.85	03 472 +2E*^	4500	2000
	0.01	8.5	12.0	5.0	0.5	5.5	5	10000	0.85	03 103 +2E*^	4000	2000
400 VDC	0.0001	9.0	15.0	6.0	0.5	5.0	5	10000	0.50	03 101 +2G*^	4000	2000
	0.0047	7.5	14.0	5.0	0.5	5.0	5	10000	0.55	03 472 +2G*^	2500	2000
	0.0056	8.5	14.0	5.0	0.5	5.5	5	10000	0.60	03 562 +2G*^	2500	2000
630 VDC	0.0001	9.0	15.0	6.0	0.5	5.0	5	10000	0.50	03 101 +2J*^	4000	2000
	0.0047	9.5	13.0	6.0	0.5	5.0	5	10000	0.45	03 472 +2J*^	2500	2000
	0.0068	9.5	14.0	6.5	0.5	5.5	5	10000	0.60	03 682 +2J*^	1500	2000
	0.01	10.5	14.0	7.0	0.5	7.5	5	10000	0.75	03 103 +2J*^	1500	2000
	0.022	13.0	18.0	9.0	0.5	8.5	5	10000	1.12	03 223 +2J*^	1500	1000
1000 VDC	0.0001	9.0	15.0	6.0	0.5	5.0	5	10000	0.50	03 101 +3A*^	4000	2000
	0.0047	10.0	14.0	6.5	0.5	5.0	5	10000	0.36	03 472 +3A*^	2500	2000
	0.0068	10.5	14.0	7.0	0.5	5.0	5	10000	0.55	03 682 +3A*^	2500	2000
1250 VDC	0.0001	9.0	15.0	6.0	0.5	5.0	5	10000	0.50	03 101 +3B*^	4000	2000
	0.001	9.0	15.0	6.5	0.5	5.0	5	10000	0.55	03 102 +3B*^	2500	2000
	0.0047	10.5	15.0	7.0	0.5	5.0	5	10000	0.55	03 472 +3B*^	2500	2000
1600 VDC	0.0001	9.0	15.0	6.0	0.5	5.0	5	10000	0.50	03 101 +3C*^	4000	2000
	0.001	9.5	15.0	8.5	0.5	5.0	5	10000	0.55	03 102 +3C*^	2500	2000
	0.0047	12.0	15.0	9.5	0.5	7.5	5	10000	0.55	03 472 +3C*^	2500	2000
2000 VDC	0.0001	9.0	15.0	6.0	0.5	5.0	5	10000	0.50	03 101 +3D*^	4000	2000
	0.0022	12.5	15.0	6.0	0.5	7.5	5	10000	0.50	03 222 +3D*^	2500	2000

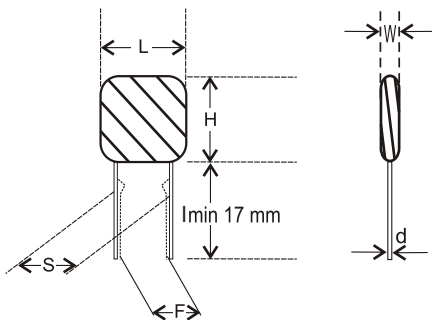

High Voltage Film Capacitors

Series Code
134

High Voltage Ceramic Disc Capacitor Replacement

Main Application

Oscillator, timing and LC/RC filter circuits, high frequency coupling of fast digital and analogue ICs.

Construction

Film/foil inductive type construction with aluminum foil as electrode and plastic film as dielectric coated with flame retardant epoxy resin.

Climatic Category

40/100/56

Applicable Specification

IEC 384-13

Rated and Maximum Temperature Rating

85°C and 100°C

Capacitance Value

0.0001µF - 0.02µF

Rated Voltage

630VDC - 2000VDC

Insulation Resistance

Minimum Insulation Resistance R_{IS}	V_R	$C_R \leq 0.1 \mu F$	$C_R > 0.1 \mu F$
(or) time constant $T = C_R \times R_{IS}$			
at 25° C, relative humidity $\leq 70\%$	≥ 630 V DC	100 GΩ	10000 s

Capacitance Tolerance

±1%, ±2%, ±2.5%, ±5%, ±10%

Voltage Proof

Between terminals: 2 times of rated voltage.

Tan δ

0.08% (maximum) at 1 kHz.

Life Test Conditions

(Loading at elevated temperature)

Loaded at 1.5 times of rated voltage at 85° C or 1.5 times of category voltage at 100° C for 1000 hours. Category voltage is 80% of rated voltage.

After the Test

$\Delta C/C \leq 5\%$ of initial value.

Increase of Tan δ: ≤ 0.01 or 1.2 times the value measured before the test, whichever is higher.

Insulation resistance: $\geq 50\%$ of the value mentioned in IR chart.

Derating graph for High Voltage Film Capacitor Series code 134

Max. Voltage (Vrms) vs. Frequency
(Sinusoidal Waveform at $T \leq 55^\circ C$)

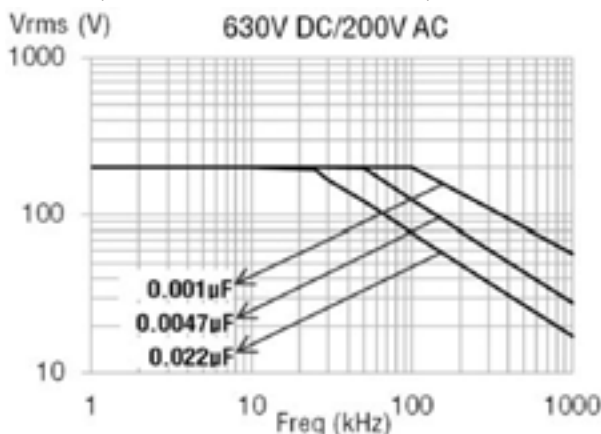

Max. Current (Irms) vs. Frequency
(Sinusoidal Waveform at $T \leq 55^\circ C$)

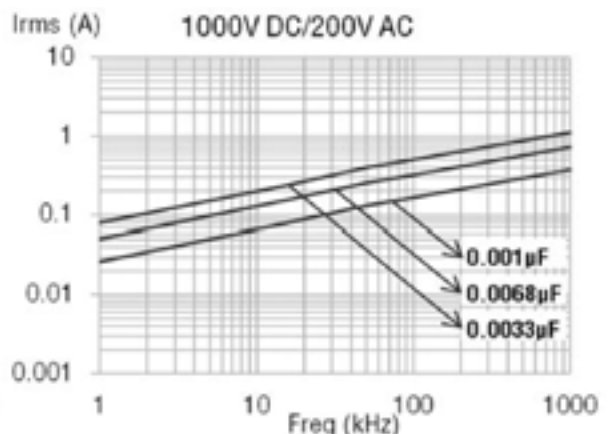
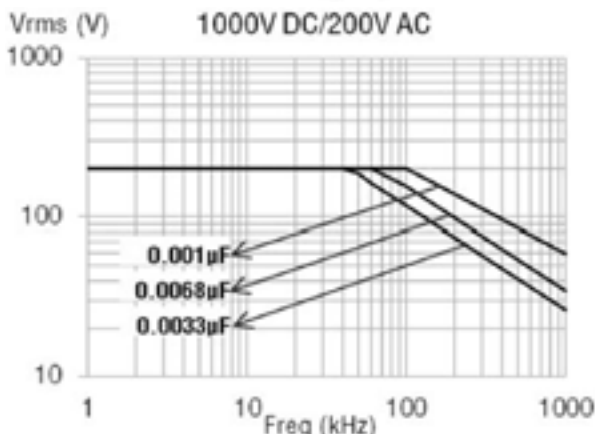
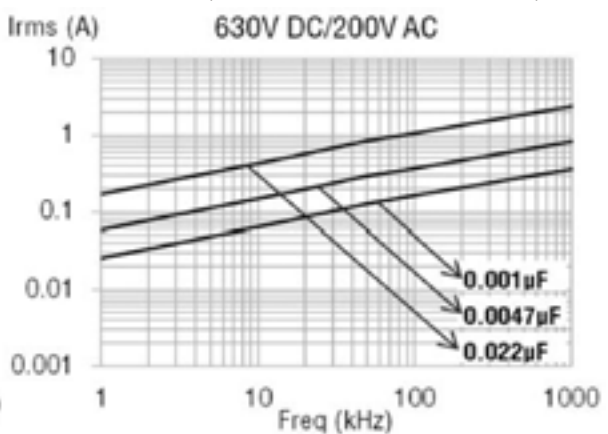

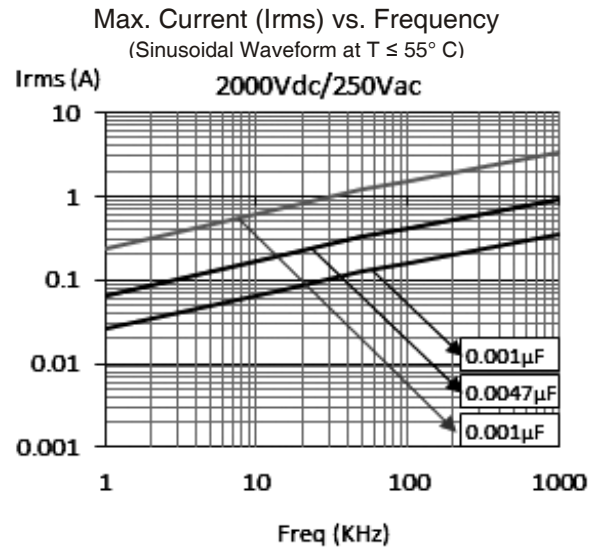
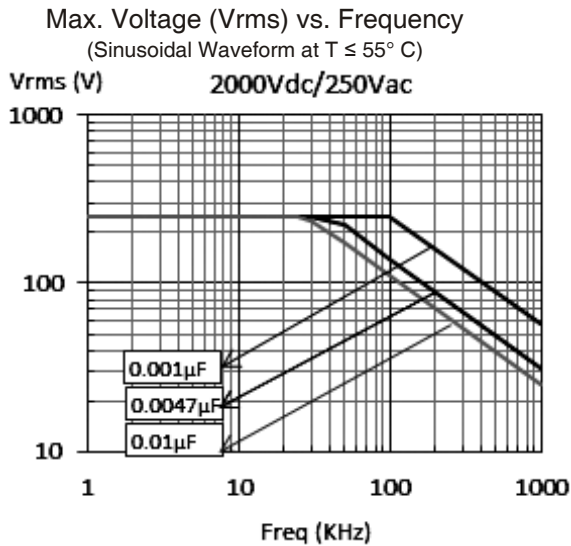

**Ordering code and packaging units: High Voltage Film Capacitor
High Voltage Ceramic Disc Capacitor Replacement Series code 134**

Rated Voltage	Rated Cap. µF	Dimensions (mm)						DV/DT V/µs	Wt. g	Ordering code	Packing units	
		W max.	H max.	L max.	d ±0.05	S ±0.5	F ±0.5				Ammo	Bulk
630V DC	0.00010	5.5	14	9.0	0.5	5.0	5	10000	0.12	134 101 +2J [^]	4500	2000
	0.00033	6.5	14	9.5	0.5	5.0	5	10000	0.13	134 331 +2J [^]	4500	2000
	0.00047	4.5	12	6.5	0.5	4.0	5	10000	0.16	134 471 +2J [^]	4500	2000
	0.00068	4.5	13	6.5	0.5	5.0	5	10000	0.20	134 681 +2J [^]	4500	2000
	0.00082	5.0	13	7.5	0.5	4.0	5	10000	0.22	134 681 +2J [^]	4500	2000
	0.00100	5.5	13	7.5	0.5	4.0	5	10000	0.24	134 102 +2J [^]	4500	2000
	0.00150	5.0	13	7.5	0.5	4.0	5	10000	0.36	134 152 +2J [^]	4500	2000
	0.00220	5.5	14	8.5	0.5	5.0	5	10000	0.38	134 222 +2J [^]	4500	2000
	0.00330	5.0	14	9.5	0.5	5.0	5	10000	0.41	134 332 +2J [^]	4000	2000
	0.00470	6.0	13	9.5	0.5	5.0	5	10000	0.45	134 472 +2J [^]	2500	2000
1000V DC	0.00010	5.5	14	9.0	0.5	5.0	5	10000	0.12	134 101 +3A [^]	4500	2000
	0.00033	6.5	14	9.5	0.5	5.0	5	10000	0.13	134 331 +3A [^]	4500	2000
	0.00047	4.5	12	6.5	0.5	4.0	5	10000	0.16	134 471 +3A [^]	4500	2000
	0.00068	4.5	13	6.5	0.5	5.0	5	10000	0.20	134 681 +3A [^]	4500	2000
	0.00082	5.0	13	7.5	0.5	4.0	5	10000	0.22	134 681 +3A [^]	4500	2000
	0.00100	6.0	14	8.5	0.5	4.5	5	10000	0.28	134 102 +3A [^]	4500	2000
	0.00220	6.5	15	9.5	0.5	5.0	5	10000	0.28	134 222 +3A [^]	4500	2000
	0.00330	6.5	14	10.0	0.5	5.0	5	10000	0.35	134 332 +3A [^]	4000	2000
	0.00470	8.0	15	11.0	0.5	5.0	5	10000	0.36	134 472 +3A [^]	2500	2000
	0.00680	8.0	15	11.5	0.5	5.0	5	10000	0.55	134 682 +3A [^]	2500	2000
2000V DC	0.00010	5.5	14	9.0	0.5	5.0	5	10000	0.12	134 101 +3D [^]	4500	2000
	0.00033	6.5	14	9.5	0.5	5.0	5	10000	0.13	134 331 +3D [^]	4500	2000
	0.00100	5.5	14	9.0	0.5	5.0	5	10000	0.28	134 102 +3D [^]	4500	2000
	0.00220	6.5	14	10.5	0.5	5.0	5	10000	0.31	134 222 +3D [^]	4500	2000
	0.00470	9.0	15	13.0	0.5	5.5	5	10000	0.38	134 472 +3D [^]	2500	2000
	0.01000	12.0	16	16.5	0.5	7.5	5	10000	0.81	134 103 +3D [^]	2000	1000

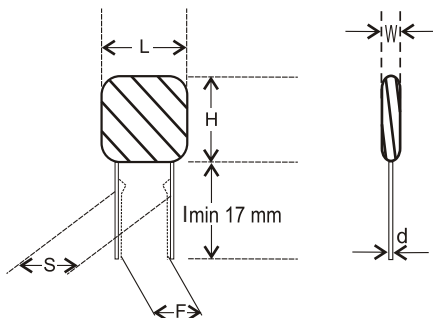

Metallized Polypropylene Film Capacitors

Series Code
04, 27, 113

Main Application

Where steep pulses occur, e.g., SMPS, motor control circuits, S-correction, etc..

Construction

Low inductive wound cell of metallized polypropylene film coated with flame epoxy resin or encased in a flame retardant box.

Climatic Category

40/100/56

Rated and Maximum Operating Temperature

85°C and 100°C

Applicable Specification

IEC 384-16

Capacitance Value

0.001µF- 4.7µF

Capacitance Tolerance

±5%, ±10%

Insulation Resistance

Minimum Insulation Resistance R_{is}
(or) time constant $T=C_R \times R_{is}$
(at 100VDC for $100 \leq V_R < 500V$,
and 500VDC for $V_R \geq 500V$,
temp 20°C, relative humidity $\leq 70\%$)

Rated Voltage

63VDC-630VDC

Voltage Proof

Between terminals: 1.6 times the rated voltage for 2 sec.

Tan δ

Frequency	$0.001\mu F \leq C_R \leq 0.1\mu F$	$0.1 \leq C_R \leq 1.0\mu F$	$C_R > 1.0\mu F$
1 kHz	$\leq 0.08\%$	$\leq 0.08\%$	$\leq 0.1\%$
10 kHz	$\leq 0.1\%$	$\leq 0.1\%$	$\leq 0.2\%$
100 kHz	$\leq 0.15\%$	$\leq 0.25\%$	$\leq 0.5\%$

Life Test Conditions

(Loading at elevated temperature)

Loaded at 1.25 times of rated voltage at 85°C for 1000 hours.

After the Test

$\Delta C/C \leq 5\%$ of initial value.

Increase of Tan δ: ≤ 0.005 , $C_R \leq 1\mu F$;

Insulation resistance: $\geq 50\%$ of the value mentioned in IR chart.

$C_R > 0.33 \mu F$
30000s

$C_R \leq 0.33 \mu F$
100000 MΩ

Derating graph for Metallized Polypropylene Film Capacitors

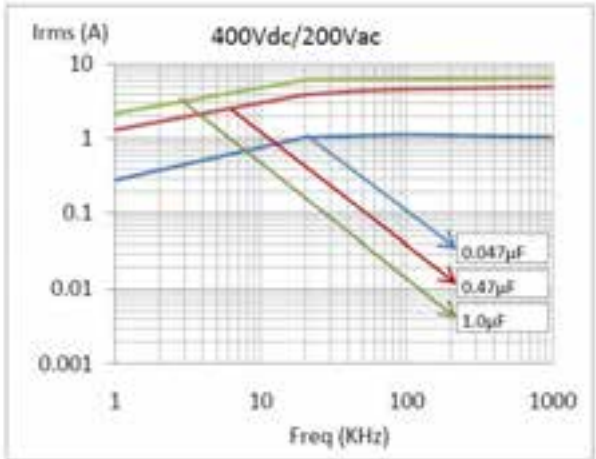
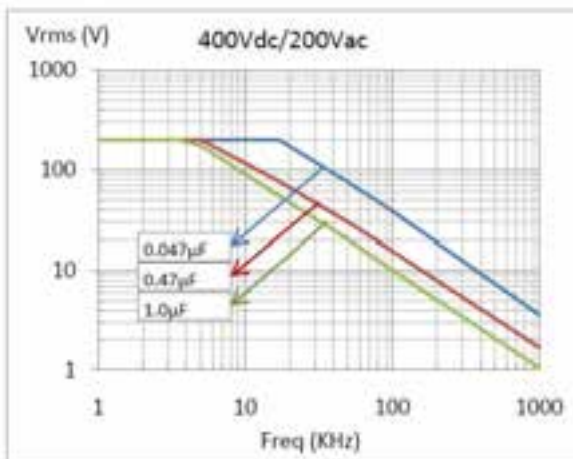
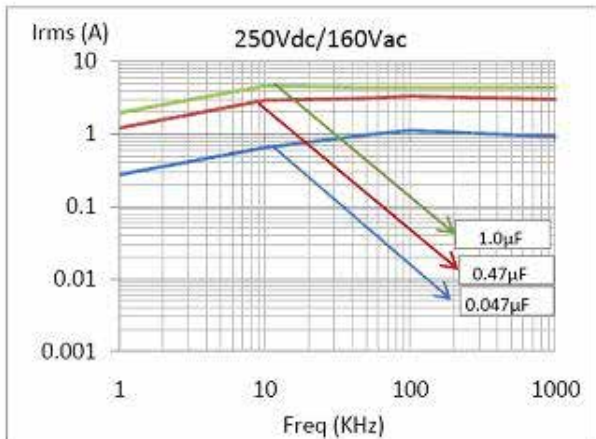
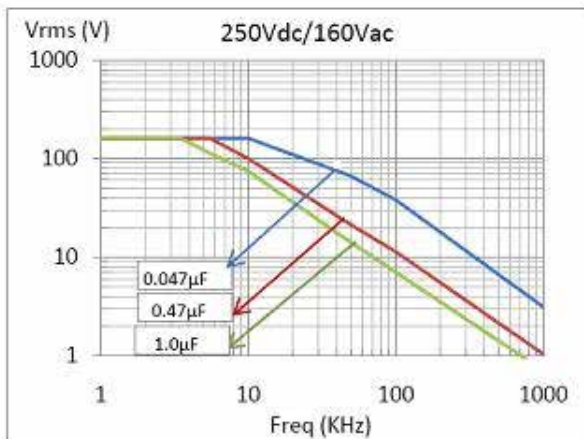

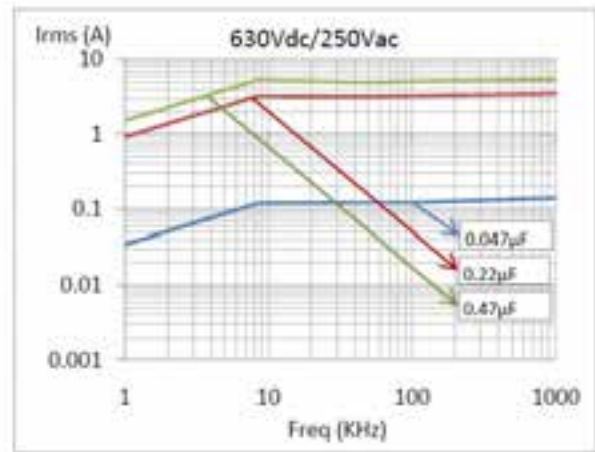
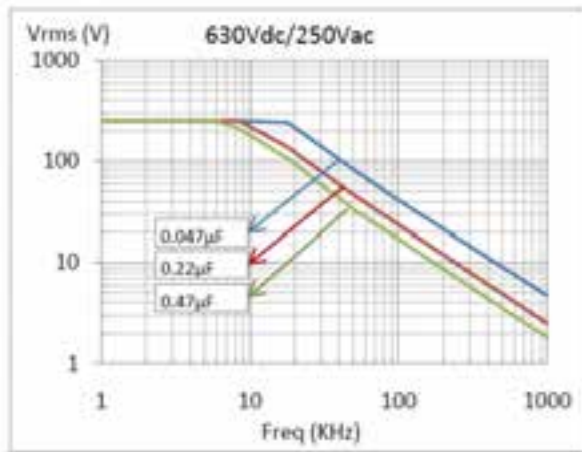

**Ordering code and packaging unit: Metallized Polypropylene Film Capacitors
Dip Type Series Code 04**

Rated Voltage	Rated Cap. (µF)	Dimensions (mm)						F ±0.5	DV/DT V/µs	Wt. g	Ordering code	Packing units Bulk
		W (Max)	H (Max)	L (Max)	d ±0.05	S ±0.75						
250 VDC	0.047	6.0	15.0	13	0.6	10.0	10.0	70	0.9	04 473 +2E*^	500	
	0.100	6.0	12.0	13	0.6	10.0	10.0	70	1.0	04 104 +2E*^	500	
	0.150	7.0	12.0	19	0.8	15.0	15.0	60	1.3	04 154 +2E*^	500	
	0.220	8.0	12.0	19	0.8	15.0	15.0	60	1.3	04 224 +2E*^	500	
	0.330	8.0	15.0	27	0.8	22.5	22.5	60	1.6	04 334 +2E*^	500	
	0.680	9.5	17.0	27	0.8	22.5	22.5	30	1.9	04 684 +2E*^	500	
	1.000	11.0	19.5	27	0.8	22.5	22.5	30	2.5	04 105 +2E*^	250	
	1.500	10.5	20.5	32	0.8	27.5	-	20	5.0	04 155 +2E*^	250	
400 VDC	2.200	13.0	21.0	31	0.8	27.5	-	20	6.5	04 225 +2E*^	250	
	0.022	6.0	12.0	13	0.6	10.0	10.0	80	0.9	04 223 +2G*^	500	
	0.047	6.0	12.0	13	0.6	10.0	10.0	80	0.9	04 473 +2G*^	500	
	0.068	6.0	12.5	19	0.8	15.0	15.0	70	1.3	04 683 +2G*^	500	
	0.100	7.0	14.0	19	0.8	15.0	15.0	70	1.4	04 104 +2G*^	250	
	0.220	8.0	16.0	19	0.8	15.0	15.0	70	1.8	04 224 +2G*^	250	
	0.27	7.0	14.0	27	0.8	22.5	22.5	35	1.8	04 274 +2G*^	250	
	0.470	9.0	21.5	27	0.8	22.5	22.5	35	2.4	04 474 +2G*^	250	
	0.560	10.0	19.0	27	0.8	22.5	22.5	35	2.6	04 564 +2G*^	250	
	0.680	9.0	18.0	31	0.8	27.5	-	29	5.0	04 684 +2G*^	250	
630VDC	0.820	11.0	21.0	31	0.8	27.5	-	29	5.5	04 824 +2G*^	250	
	1.000	12.0	22.0	31	0.8	27.5	-	29	6.0	04 105 +2G*^	250	
	0.010	6.0	12.0	13	0.6	10.0	10.0	100	0.9	04 103 +2J*^	500	
	0.022	7.0	12.0	13	0.6	10.0	10.0	100	0.9	04 223 +2J*^	500	
	0.033	6.5	16.5	19	0.8	15.0	15.0	90	1.3	04 333 +2J*^	500	
	0.047	7.0	13.0	19	0.8	15.0	15.0	90	1.3	04 473 +2J*^	500	
	0.100	9.0	15.0	19	0.8	15.0	15.0	90	1.8	04 104 +2J*^	250	
	0.120	7.0	15.0	27	0.8	22.5	22.5	45	1.7	04 124 +2J*^	250	
	0.220	10.0	17.0	27	0.8	22.5	22.5	45	2.4	04 224 +2J*^	250	
	0.330	9.5	19.5	31	0.8	27.5	-	30	5.0	04 334 +2J*^	250	
0.470	13.0	21.5	31	0.8	27.5	-	30	5.5	04 474 +2J*^	250		

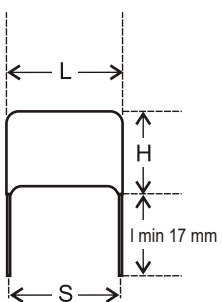

Dip Type

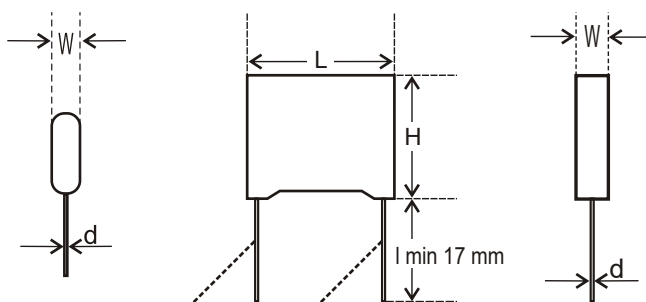

Box Type

**Ordering code and packaging unit: Metallized Polypropylene Film Capacitors
Box Type Series Code 27**

Rated Voltage	Rated Cap. (µF)	Dimensions (mm)					S ±0.75	F ±0.5	DV/DT V/µs	Wt. g	Ordering code	Packing units Bulk
		W ±0.5	H ±0.5	L ±0.5	d ±0.05							
250 VDC	0.0330	4.0	9.0	13.0	0.6	10.0	10.0	280	0.6	27 333 +2E [^]	500	
	0.0820	5.0	11.0	13.0	0.6	10.0	10.0	280	0.8	27 823 +2E [^]	500	
	0.1500	6.0	12.0	13.0	0.6	10.0	10.0	280	0.9	27 154 +2E [^]	500	
	0.1200	5.0	10.8	18.0	0.8	15.0	15.0	200	1.1	27 124 +2E [^]	500	
	0.4700	7.5	13.5	18.0	0.8	15.0	15.0	200	2.0	27 474 +2E [^]	500	
	1.0000	10.0	16.0	18.0	0.8	15.0	15.0	200	2.8	27 105 +2E [^]	500	
	0.3900	6.0	15.0	26.5	0.8	22.5	22.5	125	2.8	27 394 +2E [^]	500	
	1.0000	7.0	16.0	26.5	0.8	22.5	22.5	125	3.5	27 105 +2E [^]	250	
	1.8000	10.0	18.5	26.5	0.8	22.5	22.5	125	5.4	27 185 +2E [^]	250	
400 VDC	0.0150	4.0	9.0	13.0	0.6	10.0	10.0	420	0.6	27 153 +2G [^]	500	
	0.0330	5.0	11.0	13.0	0.6	10.0	10.0	420	0.8	27 333 +2G [^]	500	
	0.0680	6.0	12.0	13.0	0.6	10.0	10.0	420	0.9	27 683 +2G [^]	500	
	0.0680	5.0	10.8	18.0	0.8	15.0	15.0	300	1.1	27 683 +2G [^]	500	
	0.2200	7.5	13.5	18.0	0.8	15.0	15.0	300	2.0	27 224 +2G [^]	500	
	0.3300	10.0	16.0	18.0	0.8	15.0	15.0	300	2.8	27 334 +2G [^]	500	
	0.1800	6.0	15.0	26.5	0.8	22.5	22.5	180	2.8	27 184 +2G [^]	500	
	0.4700	7.0	16.0	26.5	0.8	22.5	22.5	180	3.5	27 474 +2G [^]	250	
	0.6800	10.0	18.5	26.5	0.8	22.5	22.5	180	5.4	27 684 +2G [^]	250	
630VDC	0.0010	4.0	9.0	13.0	0.6	10.0	10.0	550	0.6	27 102 +2J [^]	500	
	0.0047	4.0	9.0	13.0	0.6	10.0	10.0	550	0.6	27 472 +2J [^]	500	
	0.0270	6.0	12.0	13.0	0.6	10.0	10.0	550	0.9	27 273 +2J [^]	500	
	0.0270	5.0	10.8	18.0	0.8	15.0	15.0	400	1.1	27 273 +2J [^]	500	
	0.0680	6.0	11.9	18.0	0.8	15.0	15.0	400	1.5	27 683 +2J [^]	250	
	0.2200	10.0	16.0	18.0	0.8	15.0	15.0	400	2.8	27 224 +2J [^]	250	
	0.0820	6.0	15.0	26.5	0.8	22.5	22.5	250	2.8	27 823 +2J [^]	250	
	0.2200	7.0	16.0	26.5	0.8	22.5	22.5	250	3.5	27 224 +2J [^]	250	
	4.7000	20.0	40.0	42.0	1.0	37.5	-	-	-	27 475 +2J [^]	25	

**Ordering code and packaging unit: Metallized Polypropylene Film Capacitors
Dip Type Series Code 113**

Rated Voltage	Rated Cap. (µF)	Dimensions (mm)					S ±0.5	Wt. g	Ordering code	Packing units Bulk
		W (Max)	H (Max)	L (Max)	d ±0.05					
63VDC	0.010	6	10	10.5	0.5	7.5	1.00	113 103 + 1J [^]	500	
	0.047	6	11	10.5	0.5	7.5	1.12	113 473 + 1J [^]	500	
	0.100	6	10	10.5	0.5	7.5	1.11	113 683 + 1J [^]	500	
100VDC	0.010	6	10	10.5	0.5	7.5	1.00	113 103 + 2A [^]	500	
	0.047	6	11	10.5	0.5	7.5	1.12	113 333 + 2A [^]	500	
	0.100	6	10	10.5	0.5	7.5	1.06	113 104 + 2A [^]	500	
250VDC	0.010	6	10	10.5	0.5	7.5	1.00	113 103 + 2E [^]	500	
	0.033	6	10	10.5	0.5	7.5	1.04	113 333 + 2E [^]	500	
	0.068	7	11	10.5	0.5	7.5	1.24	113 683 + 2E [^]	500	
400VDC	0.010	6	10	10.5	0.5	7.5	1.00	113 103 + 2G [^]	500	
	0.033	6	10	10.5	0.5	7.5	1.04	113 333 + 2G [^]	500	
	0.068	7	11	10.5	0.5	7.5	1.24	113 683 + 2G [^]	500	
630VDC	0.010	6	10	10.5	0.5	7.5	1.02	113 103 + 2J [^]	500	
	0.033	7	11	10.5	0.5	7.5	1.19	113 333 + 2J [^]	500	
	0.068	8	12	10.5	0.5	7.5	1.44	113 683 + 2J [^]	500	

Fuse Type Metallized Polypropylene Film Capacitors

Series Code
92

MPP-F Series

Main Application

Smoothing in active power factor correction, LED driver, boost PFC, fly back PFC.

Construction

Low inductive wound cell of metallised polypropylene film with internal fuses coated with flame retardant epoxy resin.

Climatic Category

40/100/56

Rated and Maximum Operating Temperature

85°C and 100°C

Capacitance Value

0.047µF-4.7µF

Capacitance Tolerance

±5%, ±10%

Rated Voltage

450VDC-630VDC

Insulation Resistance

Minimum Insulation Resistance R_{IS}
(or) time constant $\tau = C_R \times R_{IS}$
at 20°C, relative humidity ≤70%

$C_R \leq 0.33\mu F$
> 30,000 MΩ

$C_R > 0.33\mu F$
> 10,000 s

Voltage Proof

Between terminals: 1.6 times the rated voltage for 2 sec.

Tan δ

Frequency(kHz)	$C_R < 0.1\mu F$	$0.1\mu F \leq C_R \leq 1\mu F$	
1kHz	0.05%	0.05%	0.08%
10 kHz	0.1%	0.08%	0.1%
100kHz	0.3%	0.8%	1.0%

Life Test Conditions

(Loading at elevated temperature)

Loaded at 1.25 times of rated voltage at 85° C for 1000 hours.

After the Test:

$\Delta C/C \leq 10\%$ of initial value.

Increase of Tan δ: ≤ 0.005 , $C_R \leq 1\mu F$

Insulation resistance: $\geq 50\%$ of the value mentioned in IR chart.

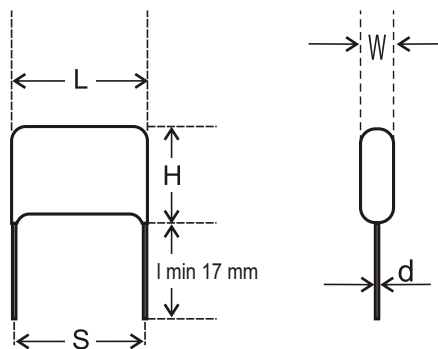

Dip Type

Ordering code and packing units: Fuse Type Metallized Polypropylene Film Capacitors
MPP-F Series Dip Type Series Code 92

Rated Voltage	Rated Cap. (μF)	Dimensions (mm)					S (±0.75)	Wt. g	Ordering Code	Packing Units Bulk
		W (Max)	H (Max)	L (Max)	d (±0.05)					
450VDC	0.047	6	11	13	0.6	10.0	1.10	92 473 + 2I ^A	500	
	0.068	6	11	13	0.6	10.0	1.30	92 683 + 2I ^A	500	
	0.100	6	11	13	0.6	10.0	1.08	92 104 + 2I ^A	500	
	0.100	6	11	19	0.8	15.0	1.40	92 104 + 2I ^A	500	
	0.410	8	15	19	0.8	15.0	2.90	92 414 + 2I ^A	500	
	0.680	10	17	19	0.8	15.0	4.30	92 684 + 2I ^A	500	
	0.330	7	12	27	0.8	22.5	2.30	92 334 + 2I ^A	500	
	0.470	8	13	27	0.8	22.5	2.90	92 474 + 2I ^A	500	
	1.000	10	17	27	0.8	22.5	5.10	92 105 + 2I ^A	250	
	0.330	6	11	31	0.8	27.5	2.20	92 334 + 2I ^A	250	
	0.470	7	13	31	0.8	27.5	2.90	92 474 + 2I ^A	250	
	1.000	9	16	31	0.8	27.5	5.00	92 105 + 2I ^A	250	
	2.200	12	21	31	0.8	27.5	9.30	92 225 + 2I ^A	250	
	4.700	17	26	31	0.8	27.5	18.00	92 475 + 2I ^A	100	
630VDC	0.047	6	11	13	0.6	10.0	1.10	92 473 + 2J ^A	500	
	0.068	7	12	13	0.6	10.0	1.50	92 683 + 2J ^A	500	
	0.100	8	13	13	0.6	10.0	1.90	92 104 + 2J ^A	500	
	0.100	6	11	19	0.8	15.0	1.40	92 104 + 2J ^A	500	
	0.220	8	15	19	0.8	15.0	2.60	92 224 + 2J ^A	500	
	0.410	10	17	19	0.8	15.0	4.20	92 414 + 2J ^A	500	
	0.330	7	14	27	0.8	22.5	3.10	92 334 + 2J ^A	500	
	0.470	8	17	27	0.8	22.5	4.00	92 474 + 2J ^A	500	
	1.000	11	20	27	0.8	22.5	7.30	92 105 + 2J ^A	250	
	0.330	7	14	31	0.8	27.5	3.00	92 334 + 2J ^A	250	
	0.470	8	15	31	0.8	27.5	3.90	92 474 + 2J ^A	250	
	1.000	10	19	31	0.8	27.5	6.90	92 105 + 2J ^A	250	
3.300	18	27	31	0.8	27.5	19.00	92 335 + 2J ^A	100		

Fuse Type Metallized Polypropylene Axial Film Capacitors

Series Code
118

(MPP-F Axial Series)

Main Application

Smoothing in active power factor correction, LED driver, boost PFC, fly back PFC.

Construction

Low inductive wound cell of metallized polypropylene film with internal fuses, wrapped with polyester tape filled with resin.

Climatic Category

40/100/21

Rated and Maximum Operating Temperature

85°C and 100°C

Capacitance Value

0.033µF - 15µF

Rated Voltage

450VDC-630VDC

Capacitance Tolerance

±5%, ±10%

Insulation Resistance

Minimum Insulation Resistance R_{IS}
(or) time constant $T = C_R \times R_{IS}$
(at 20° C, relative humidity ≤70%)

$C_R \leq 0.33\mu F$
>30000 MΩ

$C_R > 0.33 \mu F$
>10000s

Voltage Proof

Between terminals: 1.6 times the rated voltage for 2 sec.

Tan δ

Frequency	$C_R < 0.1\mu F$	$0.1\mu F \leq C_R \leq 1.0\mu F$	
$C_R > 1.0\mu F$			
At 1 kHz	0.05%	0.08%	0.1%
At 10 kHz	0.2%	0.2%	
At 100 kHz	0.8%	1.0%	

Life Test Conditions

(Loading at elevated temperature)

Loaded at 1.25 times of rated voltage at 85°C for 1000 hours.

After the Test

$\Delta C/C \leq 10\%$ of initial value.

Increase of Tan δ: ≤ 0.005 ; $C_R \leq 1\mu F$

Insulation resistance: $\geq 50\%$ of the value mentioned in IR chart.

Ordering code and packing units: Fuse Type Metallized Polypropylene Flat Axial Film Capacitors Series Code 118

Rated Voltage	Rated Cap. (µF)	Dimensions (mm)					Lead Length (min)	Weight (g)	Ordering code
		W (max)	H (max)	L (max)	d ±0.05				
450VDC	0.033	5.5	9.5	15	0.6	30	2.10	118 333 + 2I **	
	0.068	6.0	11.0	15	0.6	30	2.70	118 683 + 2I **	
	0.100	6.0	11.0	15	0.6	30	2.70	118 104 + 2I **	
	0.220	6.5	13.0	15	0.6	30	3.40	118 224 + 2I **	
	0.100	5.5	9.5	21	0.8	30	2.10	118 104 + 2I **	
	0.410	8.0	13.5	21	0.8	30	4.36	118 414 + 2I **	
	1.000	10.0	18.0	21	0.8	30	7.50	118 105 + 2I **	
	1.500	9.5	17.0	29	0.8	30	7.60	118 155 + 2I **	
	2.200	11.5	19.0	29	0.8	30	8.40	118 225 + 2I **	
	3.300	14.0	22.0	29	0.8	30	15.00	118 335 + 2I **	
	2.200	10.0	18.0	35	0.8	30	6.50	118 225 + 2I **	
	3.300	12.0	21.0	35	0.8	30	9.10	118 335 + 2I **	
	4.700	15.0	22.5	35	0.8	30	12.60	118 475 + 2I **	
	4.700	12.0	21.0	45	1.0	30	8.20	118 475 + 2I **	
	10.00	18.5	28.0	45	1.0	30	15.90	118 106 + 2I **	
15.00	23.0	33.0	45	1.0	30	23.00	118 156 + 2I **		
630VDC	0.033	5.5	9.5	15	0.6	30	2.10	118 333 + 2J **	
	0.047	5.5	10.0	15	0.6	30	2.87	118 473 + 2J **	
	0.068	5.5	11.0	15	0.6	30	2.95	118 683 + 2J **	
	0.100	5.5	9.5	21	0.8	30	2.10	118 104 + 2J **	
	0.410	10.0	15.0	21	0.8	30	5.90	118 414 + 2J **	
	0.680	12.0	17.5	21	0.8	30	8.80	118 684 + 2J **	
	0.410	7.0	13.5	29	0.8	30	3.70	118 414 + 2J **	
	1.000	10.5	18.5	29	0.8	30	7.40	118 105 + 2J **	
	1.500	13.0	21.0	29	0.8	30	10.50	118 155 + 2J **	
	1.000	9.0	17.0	35	0.8	30	5.70	118 105 + 2J **	
	2.200	12.0	20.0	45	1.0	30	7.30	118 225 + 2J **	
	4.700	16.5	26.5	45	1.0	30	14.00	118 475 + 2J **	
	10.000	25.0	35.0	45	1.0	30	28.0	118 106 + 2J **	

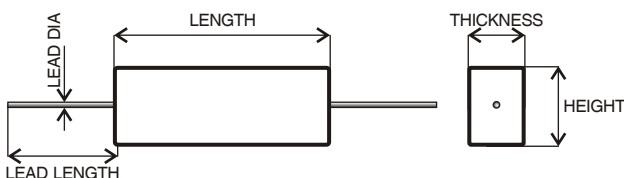

Metallized Polypropylene Axial Film Capacitors

Series Code
40, 50

Main Application

Audio circuits, integrating and filter circuits, SMPS, timing circuits, etc.

Construction

Low inductive wound cell of metallized polypropylene film as internal electrodes wrapped with polyester tape filled with resin.

Climatic Category

40/100/21

Rated and Maximum Operating Temperature

85°C and 100°C

Applicable Specification

IEC384-16

Capacitance Value

0.0047µF-10µF

Insulation Resistance

Minimum Insulation Resistance R_{IS}
(or) time constant $T = C_R \times R_{IS}$
at 25° C, relative humidity ≤70%

$C_R \leq 0.33\mu F$
50000 MΩ

$C_R > 0.33\mu F$
10000s

Capacitance Tolerance

±5%, ±10%

Rated Voltage

250VDC-1000VDC

Voltage Proof

Between terminals: 1.6 times the rated voltage for 2 sec.

Tan δ

Frequency	$0.1\mu F < C_R \leq 1\mu F$	$C_R > 1\mu F$
1 kHz	0.0008	0.001

Life Test Conditions

(Loading at elevated temperature)

Loaded at 1.25 times of rated voltage at 85°C for 1000 hours.

After the Test:

$\Delta C/C$: ≤ 10% of initial value.

Increase of Tan δ: ≤ 0.003

Insulation resistance: ≥ 50% of the value mentioned in IR chart.

Metallized Polypropylene Round Axial Film Capacitors (Series Code - 40)

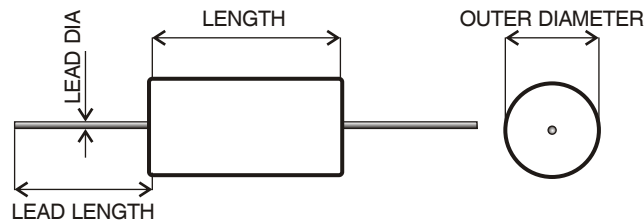

Metallized Polypropylene Flat Axial Film Capacitors (Series Code - 50)

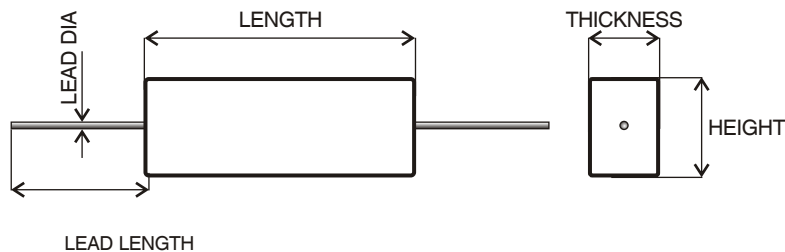

Ordering code and packing units: Metallized Polypropylene Flat Axial Film Capacitors Series Code 50

Rated Voltage	Rated Cap. (µF)	W (max)	Dimensions (mm)			d (±0.05)	dv/dt (v/µs)	Ordering Code	Packing Units Bulk
			H (max)	L (max)					
250VDC	0.0470	4.0	8.0	15	0.6	25	50 473 +2E [^]	500	
	0.1000	5.5	9.0	15	0.6	25	50 104 +2E [^]	500	
	0.1500	6.0	10.5	15	0.6	25	50 154 +2E [^]	500	
	0.3300	5.0	11.0	27	0.8	10	50 334 +2E [^]	500	
	1.0000	8.0	16.0	27	0.8	10	50 105 +2E [^]	500	
	1.5000	10.0	18.0	27	0.8	10	50 155 +2E [^]	500	
	7.5000	13.5	22.0	45	0.8	-	50 755 +2E [^]	50	
	10.0000	15.0	25.5	45	0.8	-	50 106 +2E [^]	50	
400VDC	0.0330	4.5	8.0	15	0.6	32	50 333 +2G [^]	500	
	0.0680	5.5	10.0	15	0.6	32	50 683 +2G [^]	500	
	0.1000	7.0	10.5	15	0.6	32	50 104 +2G [^]	500	
	0.2200	6.0	10.0	27	0.8	16	50 224 +2G [^]	500	
	0.4700	7.0	13.5	27	0.8	16	50 474 +2G [^]	500	
	1.0000	10.5	18.5	27	0.8	16	50 105 +2G [^]	500	
	1.5000	10.0	19.5	32	0.8	9	50 155 +2G [^]	500	
	6.8000	20.0	27.5	35	0.8	-	50 685 +2G [^]	100	
630VDC	0.0330	5.0	10.0	15	0.6	50	50 333 +2J [^]	500	
	0.0470	6.0	10.5	15	0.6	50	50 473 +2J [^]	500	
	0.2200	6.0	14.0	27	0.8	25	50 224 +2J [^]	500	
	0.4700	8.5	17.5	27	0.8	25	50 474 +2J [^]	500	
	0.6800	10.5	20.0	27	0.8	25	50 684 +2J [^]	500	
	1.0000	11.0	20.5	32	0.8	14	50 105 +2J [^]	100	
	2.2000	15.5	24.0	45	0.8	-	50 225 +2J [^]	100	
	4.7000	22.5	32.5	45	0.8	-	50 475 +2J [^]	50	
1000VDC	0.0047	4.5	8.5	15	0.6	75	50 472 +3A [^]	500	
	0.0100	6.0	10.0	15	0.6	75	50 103 +3A [^]	500	
	0.0150	7.0	11.0	15	0.6	75	50 153 +3A [^]	500	
	0.0330	5.5	11.0	27	0.8	38	50 333 +3A [^]	500	
	0.0680	7.0	14.0	27	0.8	38	50 683 +3A [^]	500	
	0.1500	9.5	18.5	27	0.8	38	50 154 +3A [^]	500	
	0.1500	8.5	17.0	32	0.8	19	50 154 +3A [^]	500	
	0.2200	10.0	19.0	32	0.8	19	50 224 +3A [^]	500	
	0.3300	12.5	21.5	32	0.8	19	50 334 +3A [^]	500	

Metallized Polyester High Capacitance Stability Film Capacitors

Series Code
23, 24

MPET AC

Main Application

This series is specially designed for energy meter applications, voltage dropper, capacitive power supply, etc for long stability of capacitance value.

Construction

Series constructed metallized polyester film and normal metallized polyester film as internal electrodes which are coated with flame retardant epoxy resin or encased in a flame retardant box.

Climatic Category

40/105/56

Rated and Maximum Operating Temperature

85°C and 105°C

Applicable Specification

IEC 384-2

Capacitance Value

0.1µF-1.0µF

Capacitance Tolerance

±5%, ±10%, ±20%

Rated Voltage

310VAC

Voltage Proof

Between terminals 1250VDC for 2 sec.

Insulation Resistance

Minimum Insulation Resistance R_{IS}
(or) time constant $T = C_R \times R_{IS}$
(at 100VDC temp 20°C, relative humidity 70%)

Tan δ

Frequency (kHz)	$C_R \leq 1.0\mu F$	$C_R > 1.0\mu F$
At 1	0.8%	1.0%

1.Damp Heat Test (Steady State)

Temperature	+40°C±2°C
Relative humidity	93%±2%RH
Duration	1000 hours

2.THB Test

(Loading at elevated temperature)
Loaded at 240VAC at 85°C with 85% relative humidity for 1000 hours.

After the Test

$\Delta C/C: \leq 10\%$
Increase of Tan δ: ≤ 0.008 at 1kHz.
Insulation Resistance: 50% of initial value.

Life Test Conditions

(Loading at elevated temperature)
Loaded at 1.25 times the rated voltage at 70°C for 1000 hours.

After the Test

$\Delta C/C: \leq 10\%$
Increase of Tan δ: ≤ 0.003 at 1kHz.
Insulation Resistance: 50% of initial value.

$C_R \leq 0.33\mu F$	$C_R > 0.33 \mu F$
30000 MΩ	10000s

Ordering code and packaging unit: Metallized Polyester High Capacitance Stability Film Capacitors
MPET AC - Box Type Series Code 23

Rated Voltage	Rated Cap. (µF)	Dimensions (mm)							Ordering code	Packing units Bulk
		W ±0.5	H ±0.5	L ±0.5	d ±0.05	S ±0.5	F ±0.75	DV/DT V/µs		
310VAC	0.18	6.00	15.00	26.50	0.8	22.5	22.5	200	23 184 +05^A	500
	0.22	6.00	15.00	26.50	0.8	22.5	22.5	200	23 224 +05^A	500
	0.27	7.00	16.50	26.50	0.8	22.5	22.5	200	23 274 +05^A	500
	0.33	7.00	16.50	26.50	0.8	22.5	22.5	200	23 334 +05^A	500
	0.39	8.50	17.00	26.50	0.8	22.5	22.5	200	23 394 +05^A	500
	0.41	8.50	17.00	26.50	0.8	22.5	22.5	200	23 414 +05^A	500
	0.47	8.50	17.00	26.50	0.8	22.5	22.5	200	23 474 +05^A	500
	0.56	10.00	18.50	26.50	0.8	22.5	22.5	200	23 564 +05^A	500
	0.68	11.00	20.00	26.50	0.8	22.5	22.5	200	23 684 +05^A	500

**Ordering code and packaging unit: Metallized Polyester High Capacitance Stability Film Capacitors
MPET AC - Dip Type Series Code 24**

Rated Voltage	Rated Cap. (µF)	Dimensions (mm)							Ordering code	Packing units Bulk
		W ±0.5	H ±0.5	L ±0.5	d ±0.05	S ±0.5	F ±0.75	DV/DT V/µs		
310VAC	0.18	6.5	12.0	25	0.8	22.5	22.5	200	24 184 +05 [^]	500
	0.22	7.0	12.5	25	0.8	22.5	22.5	200	24 224 +05 [^]	500
	0.27	7.5	13.0	25	0.8	22.5	22.5	200	24 274 +05 [^]	500
	0.33	7.5	14.5	25	0.8	22.5	22.5	200	24 334 +05 [^]	500
	0.39	8.0	15.0	25	0.8	22.5	22.5	200	24 394 +05 [^]	500
	0.41	8.5	15.5	25	0.8	22.5	22.5	200	24 414 +05 [^]	500
	0.47	9.0	16.0	25	0.8	22.5	22.5	200	24 474 +05 [^]	500
	0.56	9.5	16.5	25	0.8	22.5	22.5	200	24 564 +05 [^]	500
	0.68	10.5	17.5	25	0.8	22.5	22.5	200	24 684 +05 [^]	500
	1.00	12.5	19.5	25	0.8	22.5	22.5	200	24 105 +05 [^]	500

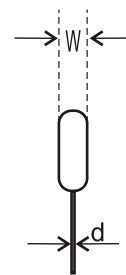
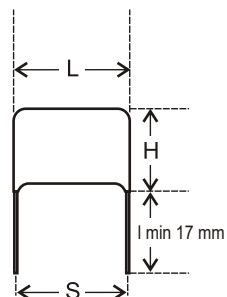
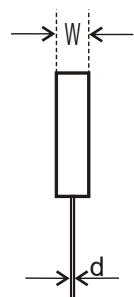
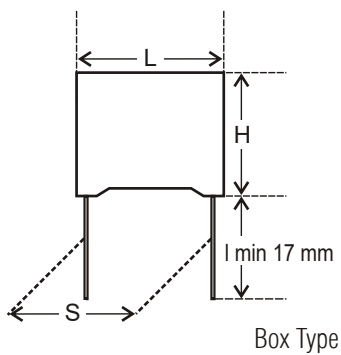

Metallized Polyester Axial Film Capacitors

Series Code
136, 148

MPET-AC Axial Series

Main Application

Low frequency AC application.

Construction

Low inductive cell of metallized polyester film wrapped with polyester tape filled by resin.

Climatic Category

40/105/21

Rated and Maximum Operating Temperature

85°C and 105°C

Applicable Specification

IEC 384-2

Capacitance Value

0.01µF-4.7µF

Capacitance Tolerance

±5%,±10%

Insulation Resistance

Minimum Insulation Resistance R_{IS}
(or) time constant $T = C_R \times R_{IS}$
Measured at 100VDC for 60 sec.
(at 25° C, relative humidity ≤70%)

Rated Voltage

250VAC-440VAC

Voltage Proof

Between terminals: 640 VDC for 2 sec.

Tan δ

Frequency	$C_R < 0.1\mu F$	$0.1\mu F \leq C_R \leq 1\mu F$	$C_R > 1\mu F$
1kHz	0.8%	1.0%	1.0%
10kHz	1.5%	1.5%	-

Life Test Conditions

(Loading at elevated temperature)

Loaded at 1.25 times of rated voltage at 70°C for 500 hours.

After the Test

$\Delta C/C \leq 10\%$ of initial value.

Increase of Tan δ: ≤ 0.005 ; $C_R \leq 1\mu F$

Insulation resistance: $\geq 50\%$ of the value mentioned in IR chart.

$C_R \leq 0.33\mu F$
30000 MΩ

$C_R > 0.33\mu F$
10000s

Metallized Polyester Round Axial Film Capacitors (Series Code - 136)

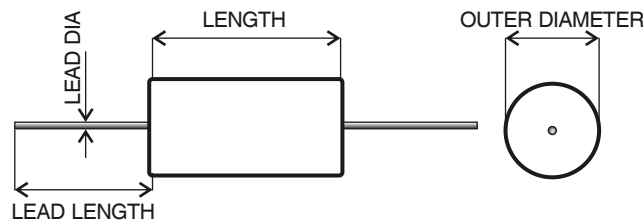

Metallized Polyester Flat Axial Film Capacitors (Series Code - 148)

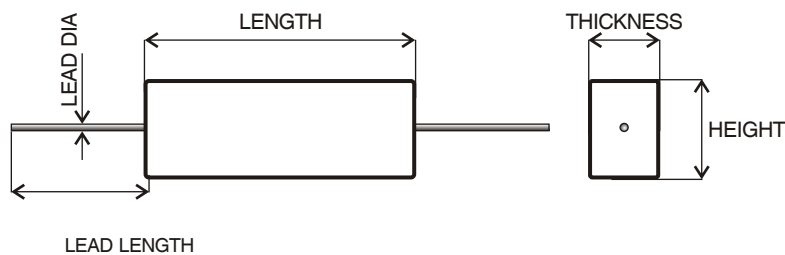

Metallized Polypropylene Film Capacitors

Series Code
17, 22, 112

MPP-AC

Main Application

This series is specially designed for energy meter applications, voltage dropper, capacitive power supply, etc.

Construction

Low inductive wound cell of metallized polypropylene film coated with flame retardant epoxy resin or encased in flame retardant box.

Climatic Category

40/100/56

Rated and Maximum Operating Temperature

85°C and 100°C

Applicable Specification

IEC 384-17

Capacitance Value

0.01µF – 2.2µF

Capacitance Tolerance

±2.5%, ±5%, ±10%

Insulation Resistance

Minimum Insulation Resistance R_{IS} $C_R \leq 0.33\mu F$ $C_R > 0.33 \mu F$
(or) time constant $T = C_R \times R_{IS}$ 100000 MΩ 30000s
(at 100VDC, temp 25°C, relative humidity ≤ 70%)

Rated Voltage

275VAC- 440VAC

Voltage Proof

Between the terminals 1250VDC for 2 sec.

Tan δ

Frequency	$C_R < 0.1\mu F$	$0.1\mu F \leq C_R \leq 1\mu F$	$C_R > 1\mu F$
1 kHz	0.08%	0.10%	0.1%
10 kHz	0.10%	0.15%	-

Life Test Conditions

(Loading at elevated temperature)

Loaded at 1.25 times of rated voltage at 70°C for 1000 hours.

After the Test

$\Delta C/C \leq 10\%$ of initial value.

Increase of Tan δ: ≤ 0.005 ; $C_R \leq 1\mu F$

Insulation resistance: $\geq 50\%$ of the value mentioned in IR chart.

Ordering code and packing units: Metallized Polypropylene Film Capacitors (MPP-AC) Dip Type Series Code 17

Rated Voltage	Rated Cap. (µF)	Dimensions (mm)						DV/DT V/µs	Ordering code	Packing units Bulk
		W (max)	H (max)	L (max)	d ±0.05	S ±0.75				
275VAC	0.1	6.0	11.00	13.0	0.6	10.0	400	17 104 +03^A	500	
	1.0	8.0	17.00	31.0	0.8	27.5	150	17 105 +03^A	100	
	2.2	12.0	21.00	31.0	0.8	27.5	150	17 225 +03^A	100	
305VAC	0.1	6.5	12.50	13.0	0.6	10.0	475	17 104 +03^A	500	
	1.0	10.0	19.00	31.0	0.8	27.5	150	17 105 +03^A	100	
	2.2	14.0	23.00	31.0	0.8	27.5	150	17 225 +03^A	100	
310VAC	0.1	6.5	12.50	13.0	0.6	10.0	475	17 104 +05^A	500	
	1.0	10.0	19.00	31.0	0.8	27.5	150	17 105 +05^A	100	
	2.2	14.0	23.00	31.0	0.8	27.5	150	17 225 +05^A	100	
440VAC	0.1	7.0	13.00	19.0	0.8	15.0	340	17 104 +06^A	500	
	1.0	13.0	23.00	27.0	0.8	22.5	170	17 105 +06^A	100	
	2.2	20.0	29.00	31.0	0.8	27.5	150	17 225 +06^A	100	

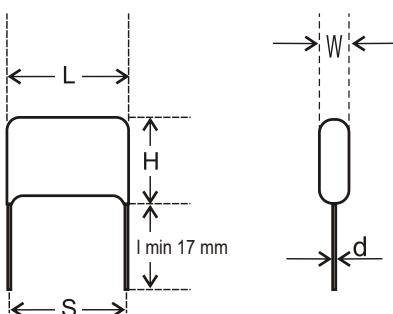

**Ordering code and packing units: Metallized Polypropylene Film Capacitors
(MPP-AC) Dip Type Series Code 112**

Rated Voltage	Rated Cap. (µF)	Dimensions (mm)					Wt g	Ordering code	Packing units Bulk
		W (max)	H (max)	L (max)	d ±0.05	S ±0.75			
250VAC	0.01	6	11	10.5	0.5	7.5	1.2	112 103 + 02 ^A	500
	0.033	6	11	10.5	0.5	7.5	1.3	112 333 + 02 ^A	500
	0.047	6	11	10.5	0.5	7.5	1.3	112 473 + 02 ^A	500
	0.068	7	11	10.5	0.5	7.5	1.5	112 683 + 02 ^A	500
275VAC	0.01	6	11	10.5	0.5	7.5	1.2	112 103 + 03 ^A	500
	0.022	6	11	10.5	0.5	7.5	1.3	112 223 + 03 ^A	500
	0.1	7	12	10.5	0.5	7.5	1.6	112 104 + 03 ^A	500
305VAC	0.01	6	11	10.5	0.5	7.5	1.2	112 103 + 04 ^A	500
	0.033	6	11	10.5	0.5	7.5	1.3	112 333 + 04 ^A	500
	0.047	7	12	10.5	0.5	7.5	1.5	112 473 + 04 ^A	500
	0.068	8	12	10.5	0.5	7.5	1.9	112 683 + 04 ^A	500
310VAC	0.01	6	12	10.5	0.5	7.5	1.2	112 103 + 05 ^A	500
	0.033	6	12	10.5	0.5	7.5	1.3	112 333 + 05 ^A	500
	0.047	7	12	10.5	0.5	7.5	1.5	112 473 + 05 ^A	500
	0.068	8	12	10.5	0.5	7.5	1.9	112 683 + 05 ^A	500
440VAC	0.01	6	12	10.5	0.5	7.5	1.2	112 103 + 06 ^A	500
	0.022	8	12	10.5	0.5	7.5	1.4	112 223 + 06 ^A	500

**Ordering code and packing units: Metallized Polypropylene Film Capacitors
(MPP-AC) Box Type Series Code 22**

Rated Voltage	Rated Cap. (µF)	Dimensions (mm)					DV/DT V/µs	Ordering code	Packing units Bulk
		W ±0.5	H ±0.5	L ±0.5	d ±0.05	S ±0.75			
275VAC	0.1	5	11.0	13.0	0.6	10.0	400	22 104 +03^A	500
	1.0	10	18.5	26.5	0.8	22.2	150	22 105 +03^A	100
	2.2	13	22.0	32.0	0.8	27.5	150	22 225 +03^A	100
305VAC	0.1	6	12.0	18.0	0.8	15.0	475	22 104 +04^A	500
	1.0	11	20.0	26.5	0.8	22.5	300	22 105 +04^A	100
	2.2	13	25.0	32.0	0.8	27.5	150	22 225 +04^A	100
310VAC	0.1	6	12.0	18.0	0.8	15.0	400	22 104 +05^A	500
	1.0	11	20.0	26.5	0.8	22.5	300	22 105 +05^A	100
	2.2	13	25.0	32.0	0.8	27.5	150	22 225 +05^A	100
440 VAC	0.1	6	12.0	18.0	0.8	15.0	340	22 104 +06^A	500
	1.0	13	25.0	32.0	0.8	27.5	170	22 105 +06^A	100
	2.2	18	33.0	32.0	0.8	27.5	150	22 225 +06^A	100

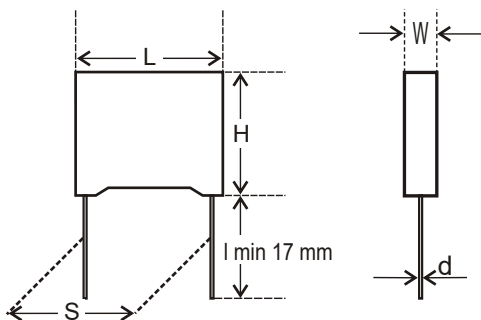

Metalized Polypropylene High Capacitance Stability Film Capacitors

Series Code
117, 122

MPP-AC-Series Construction

Main Application

This series is specially designed for energy meter applications, voltage dropper, capacitive power supply etc for long stability of capacitance value.

Construction

Series constructed metallized polypropylene film and normal metallized polypropylene film as internal electrodes as coated with flame retardant epoxy resin or encased in a flame retardant box.

Climatic Category

40/100/56

Rated Maximum Operating Temperature

85°C and 100° C

Applicable Specification

IEC 384-17

Capacitance Value

0.022 - 2.2μF

Capacitance Tolerance

±5%, ±10%, ±20%

Rated Voltage

305VAC-500VAC

Insulation Resistance

Minimum Insulation Resistance R_{IS}
(or) time constant $T = C_R \times R_{IS}$
(at 20° C, relative humidity ≤70%)

$C_R \leq 0.33 \mu F$
30000 MΩ

$C_R > 0.33 \mu F$
10000s

Tan δ

Frequency	$C_R \leq 1.0 \mu F$	$C_R > 1.0 \mu F$
At 1 kHz	0.08%	0.1%

1. Damp Heat Test (Steady State) Conditions

Temperature: 40°C±2°C
Relative humidity: 93±2%RH
Duration: 1000 hours

2. THB Test Conditions

Loaded at 240VAC at 85°C temperature with 85% relative humidity for 500 hours.

3. Life Test Conditions

(Loading at elevated temperature)

Loaded at 1.25 times of the rated voltage at 70°C for 1000 hours.

After the Test

$\Delta C/C \leq 10\%$

Increase of Tan δ: ≤ 0.005; $C_R \leq 1 \mu F$

Insulation resistance: ≥ 50% of the value mentioned in IR chart.

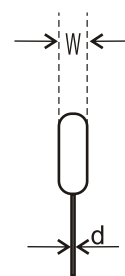
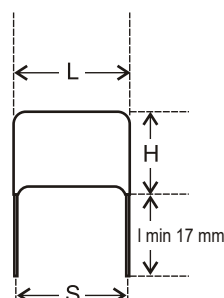
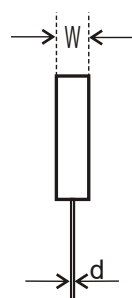
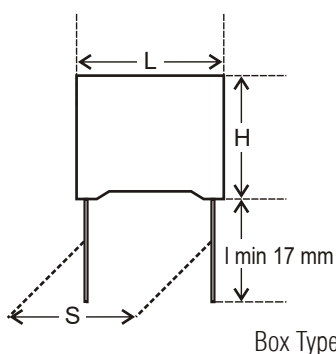

**Ordering code and packing units: Metallized Polypropylene High Capacitance Stability Film Capacitors
MPP-AC Series Construction (Dip Type) Series Code 117**

Rated Voltage	Rated Cap. (µF)	Dimensions (mm)						Wt. (g)	Ordering code
		W (max)	H (max)	L (Max)	d (±0.05)	S (±0.75)	F (±0.75)		
305VAC	0.047	7	13	19	0.8	15.0	10.0	1.7	117 473 + 04 *^
	0.100	8	14	19	0.8	15.0	10.0	2.1	117 104 + 04 *^
	0.220	11	17	19	0.8	15.0	10.0	3.8	117 224 + 04 *^
	0.100	6	11	27	0.8	22.5	15.0	1.4	117 104 + 04 *^
	0.330	9	17	27	0.8	22.5	15.0	2.8	117 334 + 04 *^
	0.680	13	21	27	0.8	22.5	15.0	5.0	117 684 + 04 *^
	0.220	7	14	31	0.8	27.5	22.5	1.8	117 224 + 04 *^
	0.470	10	16	31	0.8	27.5	22.5	3.0	117 474 + 04 *^
	1.000	14	22	31	0.8	27.5	22.5	5.4	117 105 + 04 *^
	2.200	21	29	31	0.8	27.5	22.5	10.5	117 225 + 04 *^
310VAC	0.047	7	13	19	0.8	15.0	10.0	1.7	117 473 + 05 *^
	0.068	7	13	19	0.8	15.0	10.0	1.7	117 683 + 05 *^
	0.100	8	14	19	0.8	15.0	10.0	2.1	117 104 + 05 *^
	0.220	11	17	19	0.8	15.0	10.0	3.8	117 224 + 05 *^
	0.100	6	11	27	0.8	22.5	15.0	1.4	117 104 + 05 *^
	0.330	9	17	27	0.8	22.5	15.0	2.8	117 334 + 05 *^
	0.680	13	21	27	0.8	22.5	15.0	5.0	117 684 + 05 *^
	0.220	7	14	31	0.8	27.5	22.5	1.8	117 224 + 05 *^
	0.470	10	16	31	0.8	27.5	22.5	3.0	117 474 + 05 *^
	1.000	14	22	31	0.8	27.5	22.5	5.4	117 105 + 05 *^
2.200	21	29	31	0.8	27.5	22.5	10.5	117 225 + 05 *^	
440VAC	0.033	6	11	19	0.8	15.0	10.0	1.4	117 333 + 06 *^
	0.047	7	13	19	0.8	15.0	10.0	1.8	117 473 + 06 *^
	0.100	10	16	19	0.8	15.0	10.0	2.9	117 104 + 06 *^
	0.068	6	11	27	0.8	22.5	15.0	1.4	117 683 + 06 *^
	0.100	7	13	27	0.8	22.5	15.0	1.7	117 104 + 06 *^
	0.220	10	16	27	0.8	22.5	15.0	2.9	117 224 + 06 *^
	0.330	11	19	27	0.8	22.5	15.0	4.0	117 334 + 06 *^
	0.470	13	21	27	0.8	22.5	15.0	5.2	117 474 + 06 *^
	0.100	7	12	31	0.8	27.5	22.5	1.5	117 104 + 06 *^
	0.330	11	17	31	0.8	27.5	22.5	3.2	117 334 + 06 *^
0.680	14	22	31	0.8	27.5	22.5	5.7	117 684 + 06 *^	
500VAC	0.022	6	11	19	0.8	15.0	10.0	1.4	117 223 + 07 *^
	0.033	7	13	19	0.8	15.0	10.0	1.8	117 333 + 07 *^
	0.068	9	17	19	0.8	15.0	10.0	2.9	117 683 + 07 *^
	0.033	6	10	27	0.8	22.5	15.0	1.2	117 333 + 07 *^
	0.068	8	13	27	0.8	22.5	15.0	1.9	117 683 + 07 *^
	0.100	9	15	27	0.8	22.5	15.0	2.7	117 104 + 07 *^
	0.047	6	11	31	0.8	27.5	22.5	1.32	117 473 + 07 *^
	0.100	8	14	31	0.8	27.5	22.5	2.0	117 104 + 07 *^
	0.330	12	20	31	0.8	27.5	22.5	4.5	117 334 + 07 *^
	0.680	18	26	31	0.8	27.5	22.5	8.0	117 684 + 07 *^

**Ordering code and packing units: Metallized Polypropylene High Capacitance Stability Film Capacitors
MPP-AC Series Construction (Box Type) Series Code 122**

Rated Voltage	Rated Cap. (µF)	Dimensions (mm)						Ordering code
		W (±0.5)	H (±0.5)	L (±0.5)	d (±0.05)	S (±0.75)	F (±0.75)	
305VAC	0.100	6.0	11.0	26	0.8	22.5	15.0	122 104 + 04 *^
	0.330	9.0	18.0	26	0.8	22.5	15.0	122 334 + 04 *^
	0.680	13.0	21.0	27	0.8	22.5	15.0	122 684 + 04 *^
	0.330	9.0	18.0	32	0.8	27.5	22.5	122 334 + 04 *^
	0.680	11.0	20.0	32	0.8	27.5	22.5	122 684 + 04 *^
	1.000	13.0	22.0	32	0.8	27.5	22.5	122 105 + 04 *^
	2.200	20.0	30.0	32	0.8	27.5	22.5	122 225 + 04 *^
	310VAC	0.047	6.0	12.0	18	0.8	15.0	10.0
0.068		6.0	12.0	18	0.8	15.0	10.0	122 683 + 05 *^
0.100		6.0	11.0	26	0.8	22.5	15.0	122 104 + 05 *^
0.330		9.0	18.0	26	0.8	22.5	15.0	122 334 + 05 *^
0.680		13.0	21.0	27	0.8	22.5	15.0	122 684 + 05 *^
0.330		9.0	18.0	32	0.8	27.5	22.5	122 334 + 05 *^
0.680		11.0	20.0	32	0.8	27.5	22.5	122 684 + 05 *^
1.000		13.0	22.0	32	0.8	27.5	22.5	122 105 + 05 *^
440VAC	2.200	20.0	30.0	32	0.8	27.5	22.5	122 225 + 05 *^
	0.033	6.0	12.0	18	0.8	15.0	10.0	122 333 + 06 *^
	0.047	7.0	13.5	18	0.8	15.0	10.0	122 473 + 06 *^
	0.100	8.5	17.5	18	0.8	15.0	10.0	122 104 + 06 *^
	0.220	9.0	18.0	26	0.8	22.5	15.0	122 224 + 06 *^
	0.330	12.0	22.0	26	0.8	22.5	15.0	122 334 + 06 *^
	0.330	9.0	18.0	32	0.8	27.5	22.5	122 334 + 06 *^
	0.470	11.0	20.0	32	0.8	27.5	22.5	122 474 + 06 *^
500VAC	0.680	14.0	23.5	32	0.8	27.5	22.5	122 684 + 06 *^
	0.022	6.0	12.0	18	0.8	15.0	10.0	122 223 + 07 *^
	0.047	8.5	14.0	18	0.8	15.0	10.0	122 473 + 07 *^
	0.068	8.5	17.0	18	0.8	15.0	10.0	122 683 + 07 *^
	0.047	6.0	15.0	26	0.8	22.5	15.0	122 473 + 07 *^
	0.068	6.0	15.0	26	0.8	22.5	15.0	122 683 + 07 *^
	0.100	7.0	16.0	26	0.8	22.5	15.0	122 104 + 07 *^
	0.220	9.0	18.0	32	0.8	27.5	22.5	122 224 + 07 *^
500VAC	0.470	14.0	23.5	32	0.8	27.5	22.5	122 474 + 07 *^
	0.680	18.0	26.0	32	0.8	27.5	22.5	122 684 + 07 *^

Metallized Polypropylene High Capacitance Stability Axial Film Capacitors

Series Code
119, 135

MPP-AC-Series Construction Axial Series

Main Application

This series is specially designed for energy meter applications, voltage dropper, capacitive power supply, etc. for long stability of capacitance value.

Construction

Series constructed metallized polypropylene film and normal metallized polypropylene film as internal electrodes. Wrapped with polyester tape filled with resin.

Climatic Category

40/100/21

Rated and Maximum Operating Temperature

85°C and 100°C

Applicable Specification

IEC 384-17

Capacitance Value

0.022µF - 4.7µF

Rated Voltage

250VAC-500VAC

Capacitance Tolerance

±5%, ±10%, ±20%

Insulation Resistance

Minimum Insulation Resistance R_{IS}
(or) time constant $T = C_R \times R_{IS}$
(at 100VDC temp 20°C, relative humidity 70%)

$C_R \leq 0.33\mu F$
100000 MΩ

$C_R > 0.33 \mu F$
30000s

Voltage Proof

Between terminals: 1250VDC for 2 sec.

Tan δ

Frequency	$C_R < 0.1\mu F$	$0.1\mu F \leq C_R \leq 1\mu F$	$C_R > 1\mu F$
1 kHz	0.08%	0.10%	0.1%
10 kHz	0.10%	0.15%	-

1. Damp Heat Test (Steady State)

Temperature: 40°C
Relative humidity: 93% RH
Duration: 1000 hours

2. THB Test Conditions

Loaded at 240VAC at 85°C temperature with 85% relative humidity for 500 hours.

3. Life Test Conditions

(Loading at elevated temperature)
Loaded at 1.25 times of rated voltage at 70°C for 500 hours.

After the Test

$\Delta C/C \leq 10\%$ of initial value.
Increase of Tan δ: ≤ 0.005 ; $C_R \leq 1\mu F$
Insulation resistance: $\geq 50\%$ of the value mentioned in IR chart.

Metallized Polypropylene Flat Axial Film Capacitors (Series Code - 119)

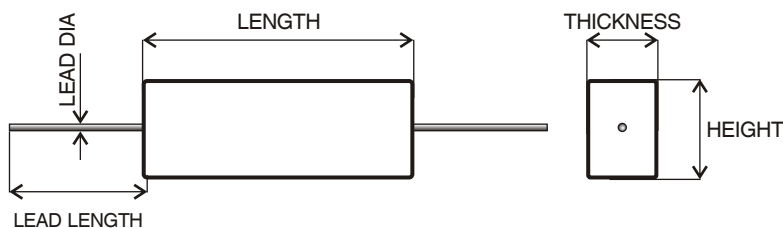

Metallized Polypropylene Round Axial Film Capacitors (Series Code - 135)

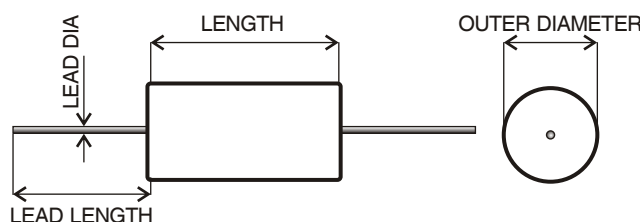

**Ordering code and packing units: Metallized Polypropylene High Capacitance Stability Axial Film Capacitors
 MPP-AC-Series Construction Flat Axial Series Series Code 119**

Rated Voltage	Rated Cap. (µF)	Dimensions (mm)				Lead Length (min)	Ordering code
		W (max)	H (max)	L (max)	d (±0.05)		
305VAC	0.068	7.0	13.0	21	0.8	30	119 683 + 04 ^A
	0.100	8.0	14.0	21	0.8	30	119 104 + 04 ^A
	0.100	6.0	11.0	29	0.8	30	119 104 + 04 ^A
	0.330	10.0	16.0	29	0.8	30	119 334 + 04 ^A
	0.680	14.0	20.0	29	0.8	30	119 684 + 04 ^A
	0.220	8.0	12.5	35	0.8	30	119 224 + 04 ^A
	0.470	10.0	16.5	35	0.8	30	119 474 + 04 ^A
	1.000	14.0	22.0	35	0.8	30	119 105 + 04 ^A
	2.200	23.0	27.5	35	0.8	30	119 225 + 04 ^A
310VAC	0.047	6.0	11.0	21	0.8	30	119 473 + 05 ^A
	0.068	7.0	13.0	21	0.8	30	119 683 + 05 ^A
	0.100	8.0	14.0	21	0.8	30	119 105 + 05 ^A
	0.100	6.0	11.0	29	0.8	30	119 105 + 05 ^A
	0.330	10.0	16.0	29	0.8	30	119 334 + 05 ^A
	0.680	14.0	20.0	29	0.8	30	119 684 + 05 ^A
	0.220	8.0	12.5	35	0.8	30	119 224 + 05 ^A
	0.470	10.0	16.5	35	0.8	30	119 474 + 05 ^A
	1.000	14.0	22.0	35	0.8	30	119 105 + 05 ^A
2.200	23.0	27.5	35	0.8	30	119 225 + 05 ^A	
440VAC	0.033	6.5	11.0	21	0.8	30	119 333 + 06 ^A
	0.047	7.5	12.0	21	0.8	30	119 473 + 06 ^A
	0.068	8.0	14.5	21	0.8	30	119 683 + 06 ^A
	0.100	10.5	15.0	21	0.8	30	119 104 + 06 ^A
	0.068	6.5	11.0	29	0.8	30	119 683 + 06 ^A
	0.100	7.5	12.0	29	0.8	30	119 104 + 06 ^A
	0.470	14.5	21.0	29	0.8	30	119 474 + 06 ^A
	0.680	18.0	23.0	29	0.8	30	119 684 + 06 ^A
	0.068	6.0	10.5	35	0.8	30	119 683 + 06 ^A
	0.100	7.5	11.5	35	0.8	30	119 104 + 06 ^A
	0.470	12.0	20.0	35	0.8	30	119 474 + 06 ^A
1.000	19.0	24.0	35	0.8	30	119 105 + 06 ^A	
500VAC	0.022	6.5	11.0	21	0.8	30	119 223 + 07 ^A
	0.033	7.0	13.0	21	0.8	30	119 333 + 07 ^A
	0.047	8.0	14.5	21	0.8	30	119 473 + 07 ^A
	0.068	10.5	15.0	29	0.8	30	119 683 + 07 ^A
	0.100	8.0	14.5	29	0.8	30	119 104 + 07 ^A
	0.330	14.0	22.0	29	0.8	30	119 334 + 07 ^A
	0.047	6.0	10.5	35	0.8	30	119 473 + 07 ^A
	0.100	7.0	13.5	35	0.8	30	119 104 + 07 ^A
	0.470	15.0	21.5	35	0.8	30	119 474 + 07 ^A
1.000	23.0	28.0	35	0.8	30	119 105 + 07 ^A	

**Ordering code and packing units: Metallized Polypropylene High Capacitance Stability Axial Film Capacitors
 MPP-AC-Series Construction Round Axial Series Series Code 135**

Rated Voltage	Rated Cap. (μF)	Outer Diameter (max)	Dimensions (mm)			Wt. (g)	Ordering code
			Length (max)	d (±0.5)	Lead Length (min)		
250VAC	0.047	10.0	15	0.6	30	1.88	135 473 + 02 *^
	0.068	10.0	15	0.6	30	1.87	135 683 + 02 *^
	0.100	10.5	15	0.6	30	2.02	135 104 + 02 *^
	0.100	10.0	21	0.8	30	2.25	135 104 + 02 *^
	0.470	11.5	21	0.8	30	3.11	135 474 + 02 *^
	1.000	15.5	21	0.8	30	5.47	135 105 + 02 *^
	0.470	10.0	29	0.8	30	2.77	135 474 + 02 *^
	1.000	13.0	29	0.8	30	4.72	135 105 + 02 *^
	1.500	15.0	29	0.8	30	6.45	135 155 + 02 *^
	0.220	10.0	35	0.8	30	3.21	135 224 + 02 *^
	1.000	11.5	35	0.8	30	4.52	135 105 + 02 *^
	3.300	18.5	35	0.8	30	11.53	135 335 + 02 *^
	1.000	10.0	45	0.8	30	4.40	135 105 + 02 *^
	2.200	13.5	45	0.8	30	7.81	135 225 + 02 *^
	4.700	18.5	45	0.8	30	14.41	135 475 + 02 *^
275VAC	0.047	10.0	15	0.6	30	1.88	135 473 + 03 *^
	0.100	10.5	15	0.6	30	2.03	135 104 + 03 *^
	0.100	10.0	21	0.8	30	2.25	135 104 + 03 *^
	0.470	11.5	21	0.8	30	3.11	135 474 + 03 *^
	1.000	15.5	21	0.8	30	5.47	135 105 + 03 *^
	0.470	10.0	29	0.8	30	2.77	135 474 + 03 *^
	1.000	13.0	29	0.8	30	4.72	135 105 + 03 *^
	1.500	15.0	29	0.8	30	6.45	135 155 + 03 *^
	0.220	10.0	35	0.8	30	3.21	135 224 + 03 *^
	1.000	11.5	35	0.8	30	4.52	135 105 + 03 *^
	3.300	18.5	35	0.8	30	11.53	135 335 + 03 *^
	1.000	10.0	45	0.8	30	4.40	135 105 + 03 *^
	2.200	13.5	45	0.8	30	7.81	135 225 + 03 *^
	4.700	18.5	45	0.8	30	14.41	135 475 + 03 *^
	305VAC	0.047	10.0	15	0.6	30	1.88
0.100		10.5	15	0.6	30	2.04	135 104 + 04 *^
0.100		10.0	21	0.8	30	2.25	135 104 + 04 *^
0.470		11.5	21	0.8	30	3.11	135 474 + 04 *^
1.000		15.5	21	0.8	30	5.47	135 105 + 04 *^
0.470		10.0	29	0.8	30	2.77	135 474 + 04 *^
1.000		13.0	29	0.8	30	4.72	135 105 + 04 *^
1.500		15.0	29	0.8	30	6.45	135 155 + 04 *^
0.220		10.0	35	0.8	30	3.21	135 224 + 04 *^
1.000		11.5	35	0.8	30	4.52	135 105 + 04 *^
3.300		18.5	35	0.8	30	11.53	135 335 + 04 *^
1.000		10.0	45	0.8	30	4.40	135 105 + 04 *^
2.200		13.5	45	0.8	30	7.81	135 225 + 04 *^
4.700		18.5	45	0.8	30	14.41	135 475 + 04 *^

**Ordering code and packing units: Metallized Polypropylene High Capacitance Stability Axial Film Capacitors
 MPP-AC-Series Construction Round Axial Series Series Code 135**

Rated Voltage	Rated Cap. (µF)	Outer Diameter (max)	Dimensions (mm)			Wt. (g)	Ordering code
			Length (max)	d (±0.5)	Lead Length (min)		
310VAC	0.047	10.0	15	0.6	30	1.88	135 473 + 05 *^
	0.100	10.0	15	0.6	30	2.42	135 104 + 05 *^
	0.220	10.0	21	0.8	30	2.39	135 224 + 05 *^
	0.470	13.0	21	0.8	30	4.08	135 474 + 05 *^
	0.470	11.0	29	0.8	30	3.60	135 474 + 05 *^
	1.000	15.0	29	0.8	30	6.28	135 105 + 05 *^
	2.200	20.0	29	0.8	30	11.99	135 225 + 05 *^
	0.220	10.0	35	0.8	30	3.21	135 224 + 05 *^
	1.000	13.5	35	0.8	30	5.97	135 105 + 05 *^
	3.300	21.5	35	0.8	30	15.79	135 335 + 05 *^
	1.000	12.0	45	0.8	30	5.73	135 105 + 05 *^
	2.200	16.0	45	0.8	30	10.48	135 225 + 05 *^
	4.700	21.5	45	0.8	30	19.71	135 475 + 05 *^
	440VAC	0.047	10.5	15	0.6	30	1.87
0.068		12.0	15	0.6	30	2.39	135 683 + 06 *^
0.100		12.5	21	0.8	30	2.25	135 104 + 06 *^
0.220		13.0	21	0.8	30	3.87	135 224 + 06 *^
0.220		11.0	29	0.8	30	3.32	135 474 + 06 *^
0.470		14.0	29	0.8	30	5.72	135 224 + 06 *^
1.000		19.0	29	0.8	30	10.5	135 684 + 06 *^
1.000		17.0	35	0.8	30	9.75	135 105 + 06 *^
1.500		20.5	35	0.8	30	13.67	135 155 + 06 *^
1.000		15.0	45	0.8	30	9.18	135 105 + 06 *^
2.200	20.5	45	0.8	30	17.47	135 225 + 06 *^	

Metallized Polypropylene Axial Film Capacitors

Series Code
52, 140

MPP-AC Axial Series

Main Application

Used in low current ac applications.

Construction

Low inductive wound cell of metallized polypropylene film wrapped with polyester tape filled by resin.

Climatic Category

40/100/21

Rated and Maximum Operating Temperature

85°C and 100°C

Applicable Specification

IEC 384-17

Capacitance Value

0.01µF-10.0µF

Capacitance Tolerance

±5%,±10%

Insulation Resistance

Minimum Insulation Resistance R_{IS}
(or) time constant $T = C_R \times R_{IS}$
Measured at 100VDC for 60 sec.
(at 25° C, relative humidity ≤70%)

$C_R \leq 0.33 \mu F$
100000 MΩ

$C_R > 0.33 \mu F$
30000 s

Rated Voltage

250VAC-440VAC

Voltage Proof

Between terminals:1200VDC for rated voltage up to 275 VAC and 1250 VDC for rated voltage above 275VAC for 2 sec.

Tan δ

0.1% (maximum) at 1kHz.

Life Test Conditions

(Loading at elevated temperature)

Loaded at 1.25 times of rated voltage at 70°C for 500 hours.

After the Test

$\Delta C/C: \leq 10\%$ of initial value.

Increase of Tan δ: ≤ 0.004

Insulation resistance: $\geq 50\%$ of the value mentioned in IR chart.

Metallized Polypropylene Flat Axial Film Capacitors (Series Code - 52)

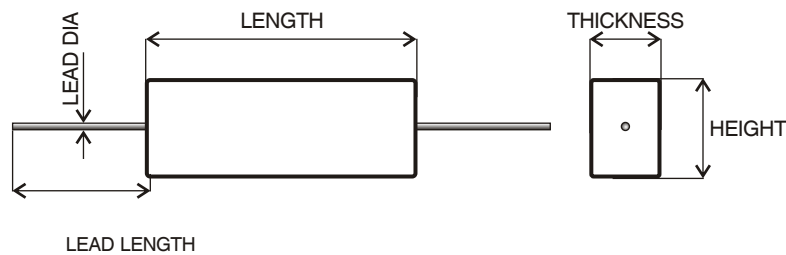

Metallized Polypropylene Round Axial Film Capacitors (Series Code - 140)

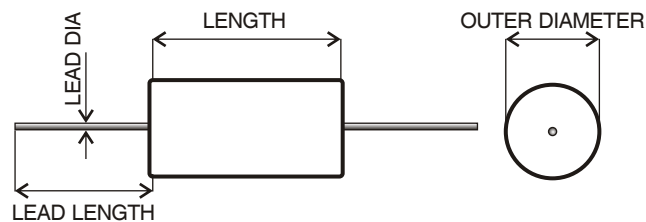

**Ordering code and packing units: Metallized Polypropylene Flat Axial Film Capacitors
MPP-AC Series Code 52**

Rated Voltage	Rated Cap. (µF)	Dimensions (mm)				Lead Length (min)	Wt (g)	Ordering Code
		W (max)	H (max)	L (max)	d (±0.05)			
250VAC	0.010	5.0	8.0	15	0.6	30	2.2	52 103 + 02 *^
	0.047	6.0	10.0	15	0.6	30	3.1	52 473 + 02 *^
	0.100	7.0	10.5	15	0.6	30	3.5	52 104 + 02 *^
	0.100	5.5	9.5	21	0.8	30	2.5	52 104 + 02 *^
	0.220	5.5	10.0	21	0.8	30	3.1	52 224 + 02 *^
	0.680	10.0	15.0	21	0.8	30	7.4	52 684 + 02 *^
	0.330	6.0	10.5	29	0.8	30	2.9	52 334 + 02 *^
	0.470	7.0	11.5	29	0.8	30	3.6	52 474 + 02 *^
	1.000	8.5	16.0	29	0.8	30	6.3	52 105 + 02 *^
	0.470	6.0	12.0	35	0.8	30	3.0	52 474 + 02 *^
	1.000	7.5	15.5	35	0.8	30	5.0	52 105 + 02 *^
	2.200	11.0	19.0	35	0.8	30	9.5	52 225 + 02 *^
	4.700	17.0	26.0	35	0.8	30	18.5	52 475 + 02 *^
	1.000	7.0	13.0	45	0.8	30	3.0	52 105 + 02 *^
	2.200	9.0	17.0	45	0.8	30	6.4	52 225 + 02 *^
	4.700	13.5	22.0	45	0.8	30	12.0	52 475 + 02 *^
6.800	16.5	26.0	45	0.8	30	16.7	52 685 + 02 *^	
10.000	20.0	30.0	45	0.8	30	23.5	52 106 + 02 *^	
275VAC	0.010	5.0	8.0	15	0.6	30	2.2	52 103 + 03 *^
	0.047	6.0	10.0	15	0.6	30	3.1	52 473 + 03 *^
	0.100	7.0	10.5	15	0.6	30	3.5	52 104 + 03 *^
	0.100	5.5	9.5	21	0.8	30	2.5	52 104 + 03 *^
	0.410	8.0	12.5	21	0.8	30	4.9	52 414 + 03 *^
	0.680	10.0	15.0	21	0.8	30	7.4	52 684 + 03 *^
	0.330	6.0	10.5	29	0.8	30	2.9	52 334 + 03 *^
	0.680	8.0	12.5	29	0.8	30	4.7	52 684 + 03 *^
	1.000	8.5	16.0	29	0.8	30	6.3	52 105 + 03 *^
	0.470	6.0	12.0	35	0.8	30	3.0	52 474 + 03 *^
	1.000	7.5	15.5	35	0.8	30	5.0	52 105 + 03 *^
	2.200	11.0	19.0	35	0.8	30	9.5	52 225 + 03 *^
	4.700	17.0	26.0	35	0.8	30	18.5	52 475 + 03 *^
	1.000	7.0	13.0	45	0.8	30	3.0	52 105 + 03 *^
	2.200	9.0	17.0	45	0.8	30	6.4	52 225 + 03 *^
	4.700	13.5	22.0	45	0.8	30	12.0	52 475 + 03 *^
6.800	16.5	26.0	45	0.8	30	16.7	52 685 + 03 *^	
10.000	20.0	30.0	45	0.8	30	23.5	52 106 + 03 *^	
310VAC	0.010	5.0	8.0	15	0.6	30	2.2	52 103 + 05 *^
	0.047	5.5	9.5	15	0.6	30	2.5	52 473 + 05 *^
	0.100	6.5	11.5	15	0.6	30	3.7	52 104 + 05 *^
	0.100	5.5	9.5	21	0.8	30	2.6	52 104 + 05 *^
	0.220	7.5	12.0	21	0.8	30	4.1	52 224 + 05 *^
	0.470	10.5	15.0	21	0.8	30	7.4	52 474 + 05 *^
	0.220	6.0	10.5	29	0.8	30	2.9	52 224 + 05 *^
	0.470	7.5	14.0	29	0.8	30	4.8	52 474 + 05 *^
	1.000	10.5	18.0	29	0.8	30	8.6	52 105 + 05 *^
	1.500	13.5	20.0	29	0.8	30	12.3	52 155 + 05 *^
	0.330	6.0	13.0	35	0.8	30	3.0	52 334 + 05 *^
	0.680	7.5	15.5	35	0.8	30	5.0	52 684 + 05 *^
	1.000	9.0	17.0	35	0.8	30	6.8	52 105 + 05 *^
	2.200	13.0	22.5	35	0.8	30	13.0	52 225 + 05 *^
	3.300	17.0	25.0	35	0.8	30	18.8	52 335 + 05 *^
	440VAC	0.010	5.0	8.0	15	0.6	30	2.2
0.022		5.5	9.5	15	0.6	30	2.7	52 223 + 06 *^
0.033		6.5	10.5	15	0.6	30	3.4	52 333 + 06 *^
0.068		6.0	11.0	21	0.8	30	3.2	52 683 + 06 *^
0.100		6.5	13.0	21	0.8	30	4.1	52 104 + 06 *^
0.220		9.5	16.0	21	0.8	30	7.6	52 224 + 06 *^
0.100		6.0	10.5	29	0.8	30	2.8	52 104 + 06 *^
0.330		9.0	15.5	29	0.8	30	6.2	52 334 + 06 *^
0.470		10.0	18.0	29	0.8	30	8.3	52 474 + 06 *^
0.680		12.0	20.0	29	0.8	30	11.3	52 684 + 06 *^
0.220		6.5	13.0	35	0.8	30	3.7	52 224 + 06 *^
0.470		9.0	16.5	35	0.8	30	6.4	52 474 + 06 *^
1.000		13.0	21.0	35	0.8	30	11.9	52 105 + 06 *^
1.500		16.0	24.0	35	0.8	30	17.0	52 155 + 06 *^
0.470		7.0	15.0	45	0.8	30	4.5	52 474 + 06 *^
1.000		10.5	18.5	45	0.8	30	7.8	52 105 + 06 *^
2.200	16.0	24.0	45	0.8	30	15.0	52 225 + 06 *^	
3.300	20.0	28.0	45	0.8	30	21.5	52 335 + 06 *^	

Ordering code and packing units: Metallized Polypropylene Round Axial Film Capacitors
MPP-AC Series Code 140

Rated Voltage	Rated Cap. (μF)	Outer Diameter (max)	Dimensions (mm)		Lead Length (min)	Wt (g)	Ordering Code	
			Length (max)	d (±0.05)				
250VAC	0.033	9.0	15	0.6	30	3.0	140 333 + 02 *^	
	0.100	9.5	15	0.6	30	3.2	140 104 + 02 *^	
	0.220	10.5	15	0.6	30	4.3	140 224 + 02 *^	
	0.100	10.0	21	0.8	30	2.42	140 104 + 02 *^	
	0.680	12.5	21	0.8	30	6.3	140 683 + 02 *^	
	1.000	12.0	29	0.8	30	5.5	140 105 + 02 *^	
	2.200	17.5	29	0.8	30	10.7	140 225 + 02 *^	
	1.000	11.5	35	0.8	30	4.3	140 105 + 02 *^	
	3.300	18.5	35	0.8	30	11.7	140 335 + 02 *^	
	1.500	12.0	45	0.8	30	4.1	140 155 + 02 *^	
	3.300	16.0	45	0.8	30	7.6	140 335 + 02 *^	
	6.800	22.0	45	0.8	30	14.2	140 685 + 02 *^	
	275VAC	0.033	9.0	15	0.6	30	3.0	140 333 + 03 *^
		0.100	9.5	15	0.6	30	3.2	140 104 + 03 *^
0.220		10.5	15	0.6	30	4.3	140 224 + 03 *^	
0.100		10.0	21	0.8	30	2.42	140 104 + 03 *^	
0.680		12.5	21	0.8	30	6.3	140 683 + 03 *^	
1.000		12.0	29	0.8	30	5.5	140 105 + 03 *^	
2.200		17.5	29	0.8	30	10.7	140 225 + 03 *^	
1.000		11.5	35	0.8	30	4.3	140 105 + 03 *^	
3.300		18.5	35	0.8	30	11.7	140 335 + 03 *^	
1.500		12.0	45	0.8	30	4.1	140 155 + 03 *^	
4.700		18.5	45	0.8	30	10.3	140 475 + 03 *^	
6.800		22.0	45	0.8	30	14.2	140 685 + 03 *^	
305VAC		0.033	9.0	15	0.6	30	3.0	140 333 + 04 *^
		0.220	12.5	15	0.8	30	5.8	140 224 + 04 *^
	0.100	10.0	21	0.8	30	3.3	140 104 + 04 *^	
	0.220	10.0	21	0.8	30	3.5	140 224 + 04 *^	
	0.220	10.0	29	0.8	30	3.0	140 224 + 04 *^	
	1.000	14.5	29	0.8	30	7.5	140 105 + 04 *^	
	1.500	17.0	29	0.8	30	10.6	140 155 + 04 *^	
	1.000	13.0	35	0.8	30	5.8	140 105 + 04 *^	
	2.200	18.0	35	0.8	30	11.3	140 225 + 04 *^	
	1.000	12.0	45	0.8	30	4.0	140 105 + 04 *^	
	3.300	18.5	45	0.8	30	10.5	140 335 + 04 *^	
	310VAC	0.033	9.0	15	0.6	30	3.0	140 333 + 05 *^
		0.220	12.5	15	0.8	30	5.8	140 224 + 05 *^
		0.100	10.0	21	0.8	30	3.3	140 104 + 05 *^
0.220		10.0	21	0.8	30	3.5	140 224 + 05 *^	
0.220		10.0	29	0.8	30	3.0	140 224 + 05 *^	
1.500		17.0	29	0.8	30	10.6	140 155 + 05 *^	
1.000		13.0	35	0.8	30	5.8	140 105 + 05 *^	
2.200		18.0	35	0.8	30	11.3	140 225 + 05 *^	
1.000		12.0	45	0.8	30	4.0	140 105 + 05 *^	
3.300		18.5	45	0.6	30	10.5	140 335 + 05 *^	
440VAC		0.033	10.0	15	0.6	30	3.5	140 333 + 06 *^
		0.068	10.5	15	0.6	30	4.0	140 683 + 06 *^
		0.100	10.0	21	0.8	30	3.5	140 104 + 06 *^
		0.220	13.5	21	0.8	30	6.5	140 224 + 06 *^
	0.220	11.0	29	0.8	30	4.0	140 224 + 06 *^	
	1.000	19.0	29	0.8	30	13.8	140 105 + 06 *^	
	0.220	10.0	35	0.8	30	3.1	140 224 + 06 *^	
	1.500	20.0	35	0.8	30	14.7	140 155 + 06 *^	
	0.330	10.0	45	0.8	30	2.9	140 334 + 06 *^	
	1.000	15.0	45	0.8	30	6.6	140 105 + 06 *^	
	2.200	20.5	45	0.8	30	12.9	140 225 + 06 *^	

AC & Pulse Metallized Polypropylene Film Capacitors

Series Code
18, 30

MPP/MPP

Main Application

SMPS, motor control circuits, deflection circuit in TV sets (fly back) and monitors electronic ballast, snubber and SCR commutating circuits and applications with high voltage and high current.

Construction

Series constructed, low inductive wound cell of metallized polypropylene film as electrodes coated with flame retardant epoxy resin or encased in a flame retardant box.

Climatic Category

40/100/56

Rated and Maximum Operating Temperature

85°C and 100°C

Applicable Specification

IEC 384-16

Capacitance Value

0.001µF-0.15 µF

Capacitance Tolerance

± 5%, ± 10%, ± 20%

Insulation Resistance

Minimum Insulation Resistance R_{IS}
(or) time constant $T = C_R \times R_{IS}$
500VDC for $V_R > 500V$
at 25° C, relative humidity ≤70%

Rated Voltage

1000VDC-2000VDC

Voltage Proof

Between terminals: 1.6 times of rated voltage for 2 sec.

Tan δ

Frequency (kHz)	$C_R < 0.1\mu F$	$0.1\mu F \leq C_R \leq 1\mu F$
At 1	0.05%	0.05%
At 10	0.08%	0.08%
At 100	0.25%	-

Life Test Conditions

(Loading at elevated temperature)

Loaded at 1.25 times of rated DC voltage at 85° C for 1000 hours.

After the Test

$\Delta C/C \leq 5\%$ of initial value.

Increase of Tan δ: ≤ 0.003

Insulation resistance: $\geq 50\%$ of the initial value mentioned in IR chart.

$C_R \leq 0.33\mu F$
100 GΩ

$C_R > 0.33 \mu F$
30000s

Derating graph for AC & Pulse Metallized Polypropylene Film Capacitors (MPP/MPP)

Max. Voltage (Vrms) vs. Frequency
(Sinusoidal Waveform at $T \leq 55^\circ C$)

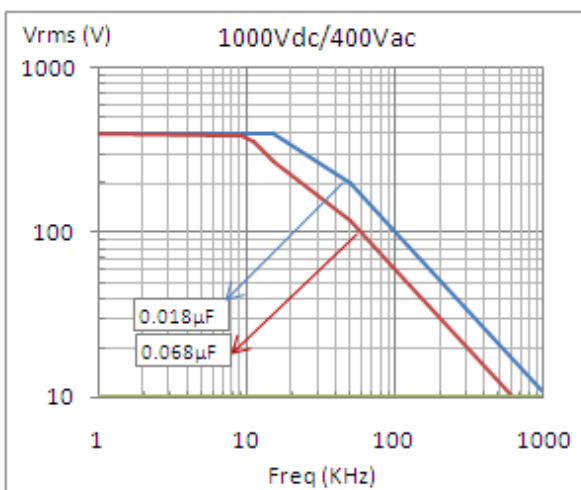

Max. Current (Irms) vs. Frequency
(Sinusoidal Waveform at $T \leq 55^\circ C$)

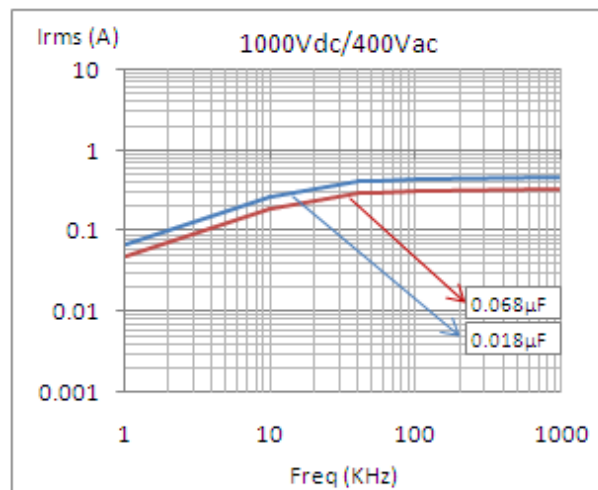

Max. Voltage (Vrms) vs. Frequency
(Sinusoidal Waveform at $T \leq 55^\circ C$)

Max. Current (Irms) vs. Frequency
(Sinusoidal Waveform at $T \leq 55^\circ C$)

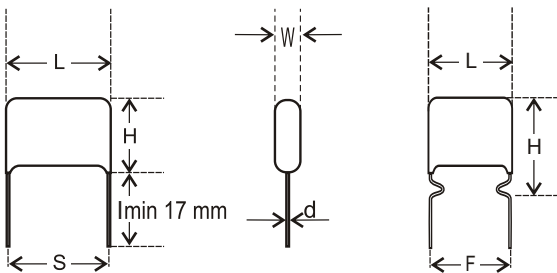
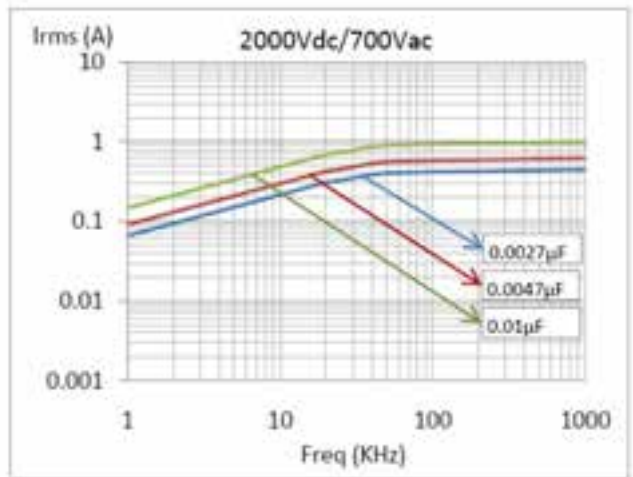
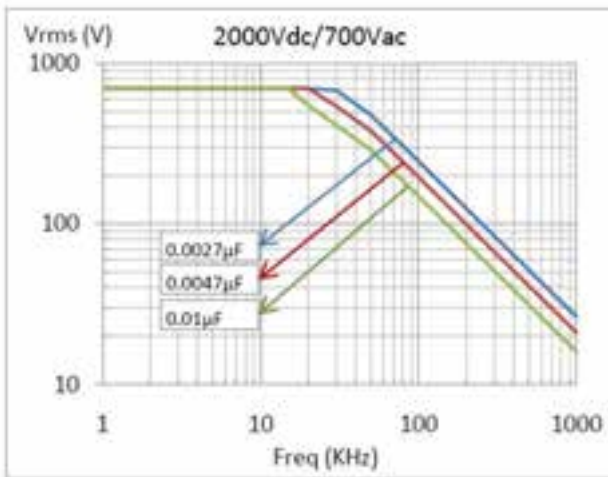
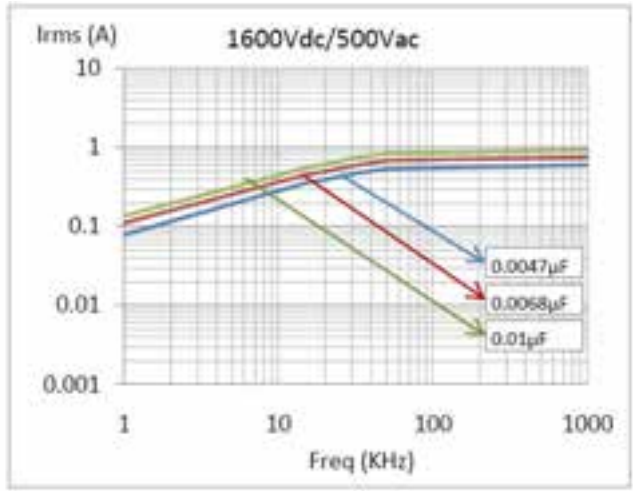
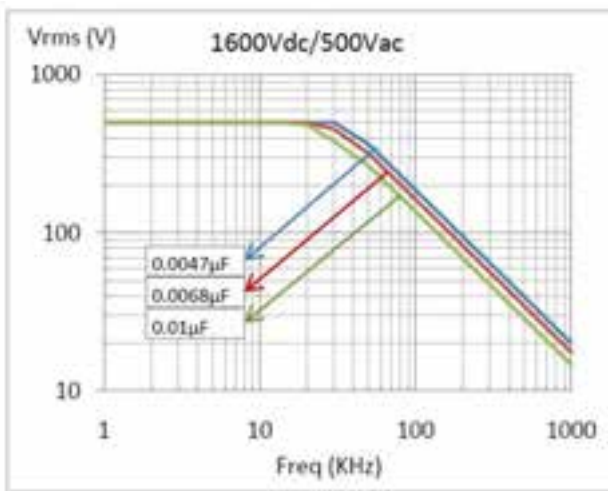
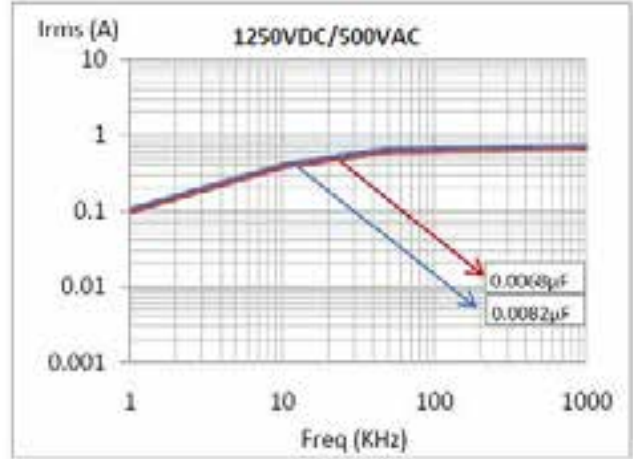
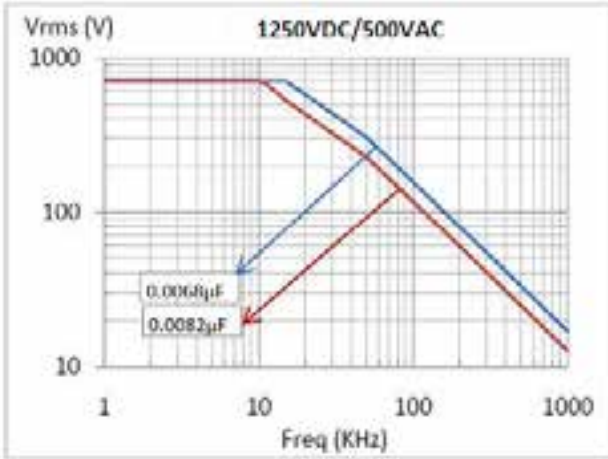

Dip Type

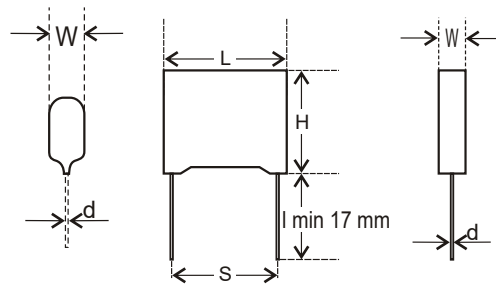

Box Type

AC & Pulse Metallized Polypropylene Film Capacitors

Series Code
05, 29

PP/MMPP Series

Main Application

SMPS, motor control circuits, deflection circuit in TV sets (fly back) and monitors, electronic ballast, snubber and SCR commutating circuits and applications with high voltage and high current.

Construction

Series constructed, polypropylene film, aluminum foil and metallized polypropylene film as internal electrodes coated with flame retardant epoxy resin or encased in a flame retardant box.

Climatic Category

40/100/56

Rated and Maximum Operating Temperature

85°C and 100°C

Applicable Specification

IEC384-16, IEC384-17

Capacitance Value

0.0001μF-0.068 μF

Capacitance Tolerance

±2%, ±5%, ±10%

Rated Voltage

1000VDC-2000VDC

Insulation Resistance

Minimum Insulation Resistance R_{IS}
(or) time constant $T = C_R \times R_{IS}$
500VDC for $V_R > 500V$
temp 20°C, relative humidity ≤ 70%)

$C_R \leq 0.33\mu F$
100 GΩ

$C_R > 0.33\mu F$
30000 s

Voltage Proof

Between terminals: 1.6 times of rated voltage for 2 sec.

Tan δ

Frequency (kHz)	$C_R < 0.1\mu F$	$0.1\mu F \leq C_R \leq 1\mu F$	$C_R > 1\mu F$
At 1	0.05%	0.08%	0.10%
At 10	0.10%	0.15%	-
At 100	0.30%	0.50%	-

Life Test Conditions

(Loading at elevated temperature)

Loaded at 1.25 times the rated DC voltage at 85° C for 1000 hours.

After the Test

$\Delta C/C \leq 5\%$ of initial value.

Increase of Tan δ: ≤ 0.003

Insulation resistance: ≥ 50% of the initial value mentioned in IR chart.

Life Test Conditions (AC)

(Loading at elevated temperature)

Loaded at 1.1 times of rated AC voltage at 70° C for 1000 hours.

After the Test:

$\Delta C/C \leq 10\%$ of initial value.

Increase of Tan δ: ≤ 0.005, ≤ $C_R 1\mu F$

Insulation resistance: ≥ 50% of the initial value mentioned in IR chart.

Derating graph for AC & Pulse Metallized Polypropylene Film Capacitors (PP/MMPP Series)

Max. Voltage (Vrms) vs. Frequency
(Sinusoidal Waveform at $T \leq 85^\circ C$)

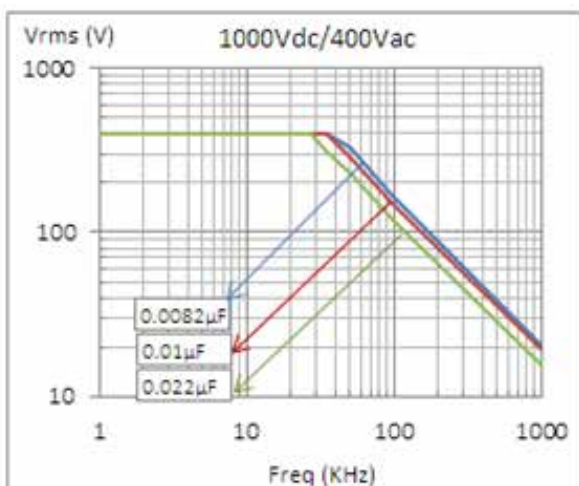

Max. Current (Irms) vs. Frequency
(Sinusoidal Waveform at $T \leq 85^\circ C$)

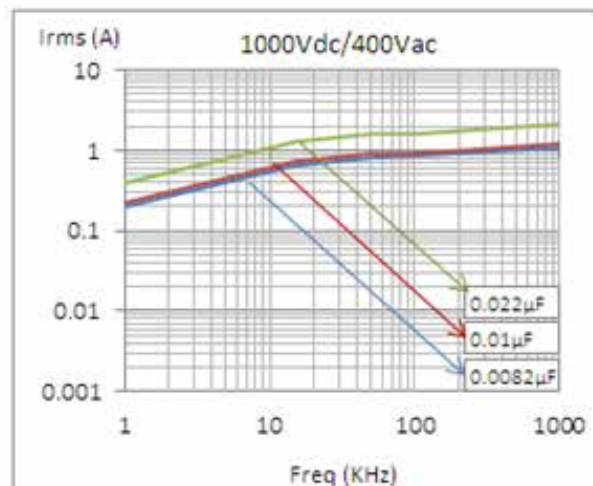

**Ordering code and packing units: AC & Pulse Metallized Polypropylene Film Capacitor
(MPP/MPP) Dip Type Series Code 18**

Rated Voltage	Rated Cap. (µF)	Dimensions (mm)						DV/DT V/µs	Wt. g	Ordering code	Packing units Bulk	
		W (max)	H (max)	L (max)	d ±0.05	S ±0.5	F ±0.5					
1000VDC	0.018	6.5	11.5	19	0.8	15.0	15.0	3000		18 183 +3A*^	250	
400VAC	0.068	11.5	19.0	19	0.8	15.0	15.0	3000		18 683 +3A*^	250	
	0.1	13.0	21.0	19	0.8	15.0	15.0	3000		18 104 +3A*^	250	
1250VDC	0.0082	5.5	11.5	19	0.8	15.0	15.0	3300	1.4	18 822 +3B*^	1000	
	500VAC	0.033	10.5	16.5	19	0.8	15.0	15.0	3300	2.6	18 333 +3B*^	1000
		0.047	10.5	17.0	19	0.8	15.0	15.0	3300	2.6	18 473 +3B*^	1000
		0.033	6.5	15.5	27	0.8	22.5	22.5	2100	2.5	18 333 +3B*^	400
		0.082	10.5	19.0	27	0.8	22.5	22.5	2100	5.0	18 823 +3B*^	400
	0.15	13.0	21.0	27	0.8	22.5	22.5	2100	5.2	18 154 +3B*^	200	
1600VDC	0.0022	5.5	11.5	19	0.8	15.0	15.0	4500	1.1	18 222 +3C*^	1000	
500VAC	0.01	8.0	14.0	19	0.8	15.0	15.0	4500	2.0	18 103 +3C*^	1000	
	0.022	10.5	16.5	19	0.8	15.0	15.0	4500	2.8	18 223 +3C*^	1000	
		0.056	10.5	19.0	27	0.8	22.5	22.5	3000	5.0	18 563 +3C*^	400
		0.12	13.0	22.0	27	0.8	22.5	22.5	3000	5.2	18 124 +3C*^	200
2000VDC	0.001	5.5	11.5	19	0.8	15.0	15.0	9500	1.1	18 102 +3D*^	1000	
700VAC	0.01	8.0	14.0	19	0.8	15.0	15.0	9500	2.0	18 103 +3D*^	1000	
	0.027	11.0	20.0	19	0.8	15.0	15.0	9500	2.6	18 273 +3D*^	1000	
	0.0047	6.5	15.5	27	0.8	22.5	22.5	3500	2.6	18 472 +3D*^	400	
	0.01	6.5	15.5	27	0.8	22.5	22.5	3500	2.6	18 103 +3D*^	400	
	0.047	10.5	19.0	27	0.8	22.5	22.5	3500	5.0	18 473 +3D*^	200	

**Ordering code and packing units: AC & Pulse Metallized Polypropylene Film Capacitor
(MPP/MPP) Box Type Series Code 30**

Rated Voltage	Rated Cap. (µF)	Dimensions (mm)						DV/DT V/µs	Wt. g	Ordering code	Packing units Bulk	
		W ±0.5	H ±0.5	L ±0.5	d ±0.05	S ±0.5	F ±0.5					
1000VDC	0.018	5.0	11.0	18.0	0.8	15.0	15.0	3000		30 183 +3A*^	500	
400VAC	0.068	8.5	16.0	18.0	0.8	15.0	15.0	3000		30 683 +3A*^	500	
	0.1	10.0	16.0	18.0	0.8	15.0	15.0	3000		30 104 +3A*^	500	
1250VDC	0.0082	5.0	10.8	18.0	0.8	15.0	15.0	3300	1.1	30 822 +3B*^	1000	
	500VAC	0.022	7.5	13.5	18.0	0.8	15.0	15.0	3300	2.0	30 223 +3B*^	1000
		0.039	10.0	16.0	18.0	0.8	15.0	15.0	3300	2.8	30 393 +3B*^	1000
		0.068	8.5	17.0	26.5	0.8	22.5	22.5	2100	4.5	30 683 +3B*^	400
	0.1	10.0	18.5	26.5	0.8	22.5	22.5	2100	5.4	30 104 +3B*^	200	
1600VDC	0.0022	5.0	10.8	18.0	0.8	15.0	15.0	4500	1.1	30 222 +3C*^	1000	
500VAC	0.01	7.5	13.5	18.0	0.8	15.0	15.0	4500	2.0	30 103 +3C*^	1000	
	0.022	10.0	16.0	18.0	0.8	15.0	15.0	4500	2.8	30 223 +3C*^	1000	
	0.047	8.5	17.0	26.5	0.8	22.5	22.5	3000	4.5	30 473 +3C*^	400	
	0.068	10.0	18.5	26.5	0.8	22.5	22.5	3000	5.4	30 683 +3C*^	200	
2000VDC	0.001	5.0	10.8	18.0	0.8	15.0	15.0	9500	1.1	30 102 +3D*^	1000	
700VAC	0.0082	7.5	13.5	18.0	0.8	15.0	15.0	9500	2.0	30 822 +3D*^	1000	
	0.018	10.0	16.0	18.0	0.8	15.0	15.0	9500	2.8	30 183 +3D*^	1000	
	0.047	10.0	18.5	26.5	0.8	22.5	22.5	3500	5.4	30 473 +3D*^	200	

Max. Voltage (Vrms) vs. Frequency
(Sinusoidal Waveform at $T \leq 85^\circ\text{C}$)

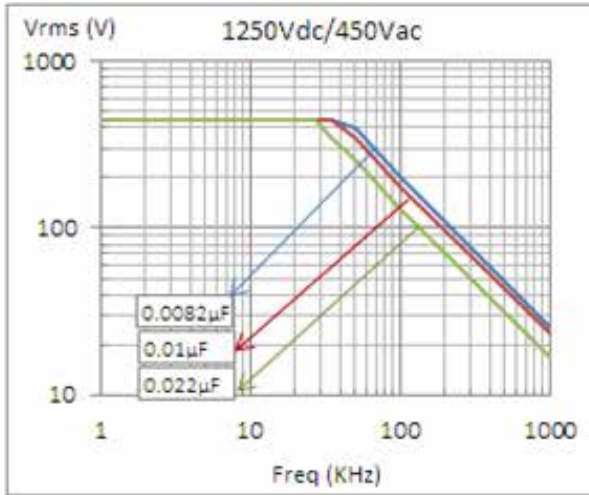

Max. Current (Irms) vs. Frequency
(Sinusoidal Waveform at $T \leq 85^\circ\text{C}$)

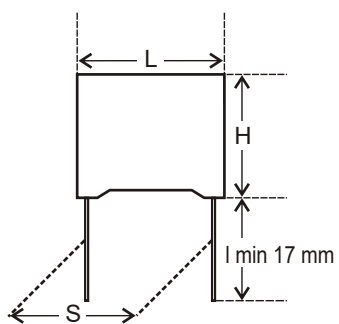
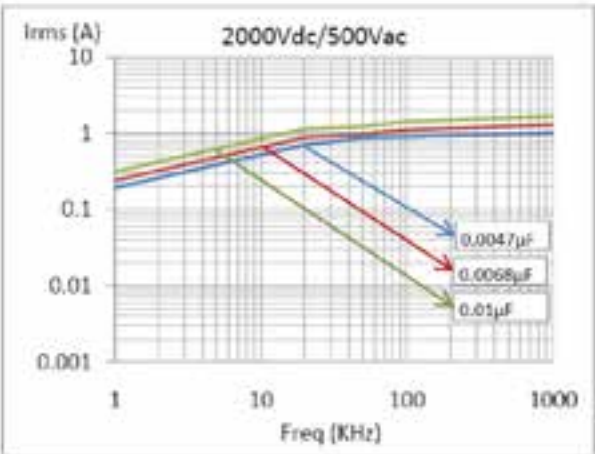
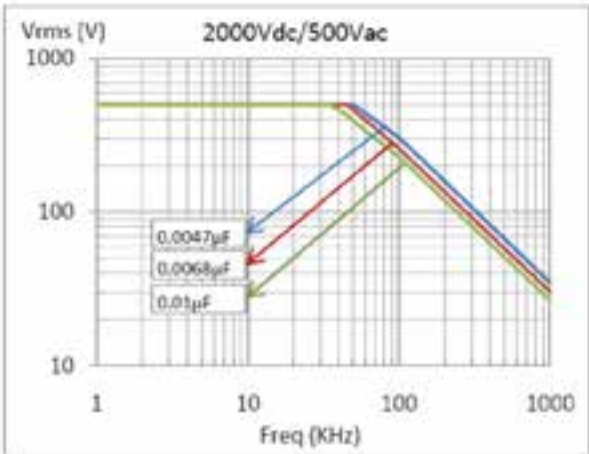
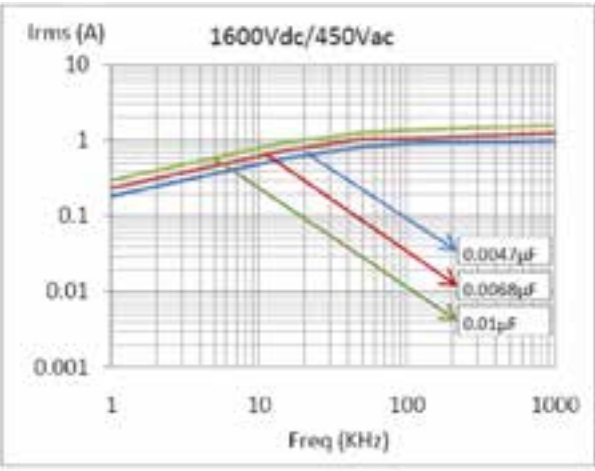
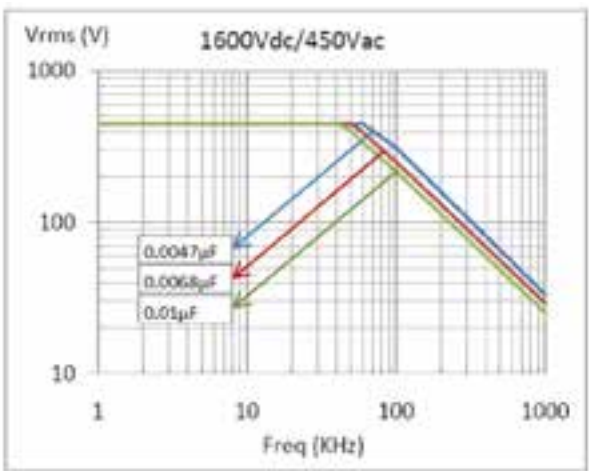
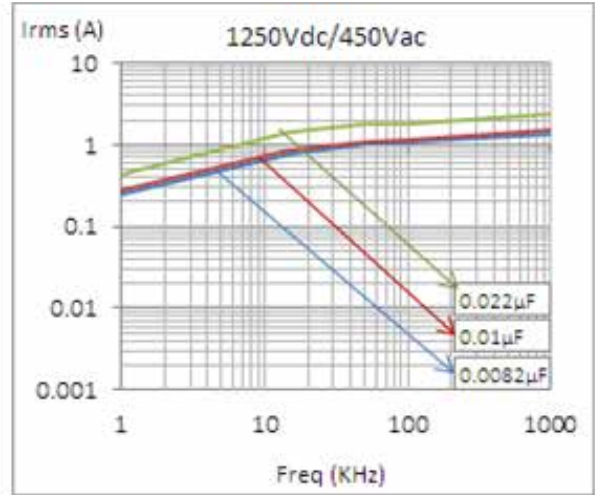

Box version

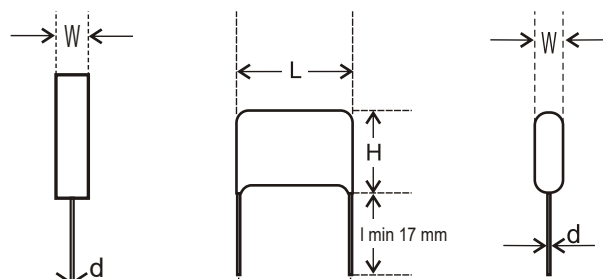

Dip version

**Ordering code and packaging unit: AC & Pulse Metallized Polypropylene Film Capacitors
(PP/MMPP Series) Dip Type Series Code 05**

Rated Voltage	Rated Cap. (µF)	Dimensions (mm)						DV/DT V/µs	Wt. g	Ordering code	Packing units	
		W max.	H max.	L max.	d ±0.05	S ±0.75	F ±0.75				Ammo	Bulk
1000VDC	0.0033	5	10	19	0.8	15.0	15.0	28000	1.1	05 332 +3A*^	1100	1000
400VAC	0.01	6	11	19	0.8	15.0	15.0	28000	1.5	05 103 +3A*^	1100	1000
	0.027	8	15	19	0.8	15.0	15.0	28000	3.5	05 273 +3A*^	700	1000
	0.015	5	12	27	0.8	22.5	22.5	11000	2.4	05 153 +3A*^	650	400
	0.047	8	15	27	0.8	22.5	22.5	11000	4.2	05 473 +3A*^	500	400
	0.068	10	16	27	0.8	22.5	22.5	11000	5.3	05 683 +3A*^	-	200
1250VDC	0.0022	5	10	19	0.8	15.0	15.0	30000	1.1	05 222 +3B*^	1100	1000
450VAC	0.0047	5	10	19	0.8	15.0	15.0	30000	1.1	05 472 +3B*^	1100	1000
	0.0082	6	12	19	0.8	15.0	15.0	30000	1.5	05 822 +3B*^	1100	1000
	0.0082	5	12	27	0.8	22.5	22.5	11000	2.2	05 822 +3B*^	650	400
	0.01	5	12	27	0.8	22.5	22.5	11000	2.3	05 103 +3B*^	650	400
	0.033	8	15	27	0.8	22.5	22.5	11000	4.1	05 333 +3B*^	500	400
1600VDC	0.001	5	10	19	0.8	15.0	15.0	34000	1.1	05 102 +3C*^	1100	1000
450VAC	0.0033	6	13	19	0.8	15.0	15.0	34000	1.5	05 332 +3C*^	1100	1000
	0.0068	8	15	19	0.8	15.0	15.0	34000	3.0	05 682 +3C*^	700	1000
	0.0056	6	12	27	0.8	22.5	22.5	11000	2.4	05 562 +3C*^	650	400
	0.01	7	13	27	0.8	22.5	22.5	11000	2.9	05 103 +3C*^	650	400
	0.022	10	16	27	0.8	22.5	22.5	11000	4.7	05 223 +3C*^	-	200
2000VDC	0.0001	4	9	19	0.8	15.0	15.0	54000	1.1	05 101 +3D*^	1100	1000
500VAC	0.001	6	12	19	0.8	15.0	15.0	54000	1.5	05 102 +3D*^	1100	1000
	0.0027	7	13	19	0.8	15.0	15.0	54000	2.4	05 272 +3D*^	900	1000
	0.0027	5	12	27	0.8	22.5	22.5	11000	2.2	05 272 +3D*^	650	400
	0.0068	7	14	27	0.8	22.5	22.5	11000	3.1	05 682 +3D*^	650	400
	0.012	10	20	27	0.8	22.5	22.5	11000	4.0	05 123 +3D*^	500	400

**Ordering code and packaging unit: AC & Pulse Metallized Polypropylene Film Capacitors
(PP/MMPP Series) Box Type Series Code 29**

Rated Voltage	Rated Cap. (µF)	Dimensions (mm)						DV/DT V/µs	Wt. g	Ordering code	Packing units	
		W ±0.5	H ±0.5	L ±0.5	d ±0.05	S ±0.75	F ±0.75				Ammo	Bulk
1000VDC	0.0033	5.0	10.8	18.0	0.8	15.0	15.0	28000	1.1	29 332 +3A*^	1100	1000
400VAC	0.01	6.0	12.0	18.0	0.8	15.0	15.0	28000	1.5	29 103 +3A*^	1100	1000
	0.027	10.0	16.0	18.0	0.8	15.0	15.0	28000	3.5	29 273 +3A*^	700	1000
	0.015	6.0	15.0	26.5	0.8	22.5	22.5	11000	2.4	29 153 +3A*^	650	400
	0.033	7.0	16.0	26.5	0.8	22.5	22.5	11000	3.5	29 333 +3A*^	650	400
	0.056	10.0	18.5	26.5	0.8	22.5	22.5	11000	4.7	29 563 +3A*^	500	400
1250VDC	0.0022	5.0	10.8	18.0	0.8	15.0	15.0	30000	1.1	29 222 +3B*^	1100	1000
450VAC	0.0047	7.5	13.5	18.0	0.8	15.0	15.0	30000	1.9	29 472 +3B*^	1100	1000
	0.0082	6.0	15.0	26.5	0.8	15.0	15.0	30000	2.2	29 822 +3B*^	650	400
	0.01	6.0	15.0	26.5	0.8	22.5	22.5	11000	2.3	29 103 +3B*^	650	400
	0.022	8.5	17.0	26.5	0.8	22.5	22.5	11000	3.3	29 223 +3B*^	650	400
	0.033	10.0	18.5	26.5	0.8	22.5	22.5	11000	4.1	29 333 +3B*^	500	400
1600VDC	0.001	5.0	10.8	18.0	0.8	15.0	15.0	34000	1.1	29 102 +3C*^	1100	1000
450VAC	0.0033	7.5	13.5	18.0	0.8	15.0	15.0	34000	2.1	29 332 +3C*^	1100	1000
	0.0068	10.0	16.0	18.0	0.8	15.0	15.0	34000	3	29 682 +3C*^	700	1000
	0.0056	6.0	15.0	26.5	0.8	22.5	22.5	34000	2.4	29 562 +3C*^	650	400
	0.01	6.0	15.0	26.5	0.8	22.5	22.5	11000	2.9	29 103 +3C*^	650	400
	0.022	10.0	18.5	26.5	0.8	22.5	22.5	11000	4.7	29 223 +3C*^	-	200
2000VDC	0.0001	5.0	10.8	18.0	0.8	15.0	15.0	11000	1.1	29 101 +3D*^	1100	1000
500VAC	0.001	6.0	11.9	19.0	0.8	15.0	15.0	54000	1.5	29 102 +3D*^	1100	1000
	0.0027	6.0	15.0	26.5	0.8	15.0	15.0	54000	2.2	29 272 +3D*^	650	400
	0.0033	6.0	15.0	26.5	0.8	22.5	22.5	11000	2.3	29 332 +3D*^	650	400
	0.0068	8.5	17.0	26.5	0.8	22.5	22.5	11000	3.1	29 682 +3D*^	650	400
	0.01	10.0	18.5	26.5	0.8	22.5	22.5	11000	3.7	29 103 +3D*^	500	400

AC Pulse & Metallized Polypropylene Film Capacitors

Series Code
63, 68

PP/MPP

Main Application

SMPS, electronic ballast, resonant capacitor, snubber application with high voltage and high current.

Construction

Series constructed, impregnated polypropylene film, aluminium foil and metallized polypropylene film as internal electrodes coated by hard, water repellent, solvent resistant epoxy resin or enclosed in a flame retardant box.

Climatic Category

40/100/56

Rated and Maximum Operating Temperature

85°C and 100°C

Applicable Specification

IEC 384-16

Capacitance Value

0.0068μF-0.47μF

Capacitance Tolerance

±5%, ±10%

Insulation Resistance

Minimum Insulation Resistance R_{IS}
(or) time constant $T = C_R \times R_{IS}$
500VDC for $V_R > 500V$
(temp 20° C, relative humidity ≤ 70%)

Rated Voltage

1000VDC-2000VDC

Voltage Proof

Between terminals 1.6 times of rated voltage for 2sec.

Tan δ

Frequency (kHz)	$C_R < 0.1\mu F$	$0.1 \leq C_R \leq 1.0\mu F$
At 1	0.05%	0.08%
At 10	0.1%	0.1%
At 100	0.3%	0.5%

Life Test Conditions

(Loading at elevated temperature)

Loaded at 1.25 times the rated DC voltage at 85° C for 1000 hours.

After the Test

$\Delta C/C \leq 5\%$ of initial value.

Change in Tan δ: 0.003

Insulation resistance: ≥ 50% of the value mentioned in IR chart.

Minimum Insulation Resistance R_{IS}	V_R	$C_R \leq 0.33 \mu F$	$C_R > 0.33 \mu F$
(or) time constant $T = C_R \times R_{IS}$	≤ 500 V DC	100 GΩ	30000s

Derating graph for AC Pulse & Metallized Polypropylene Film Capacitors PP/MPP

Max. Voltage (Vrms) vs. Frequency
(Sinusoidal Waveform at T ≤ 85° C)

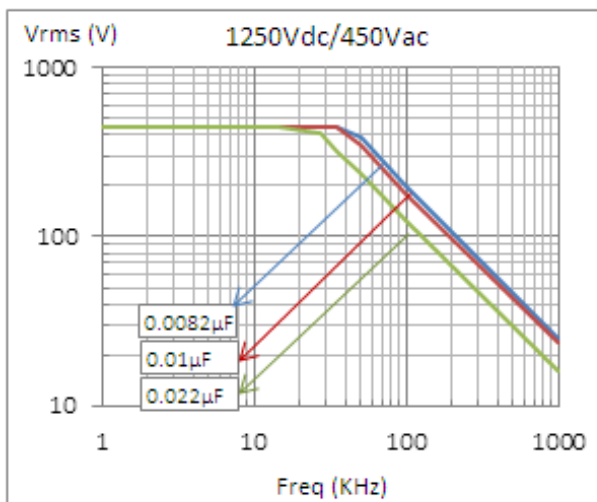

Max. Current (Irms) vs. Frequency
(Sinusoidal Waveform at T ≤ 85° C)

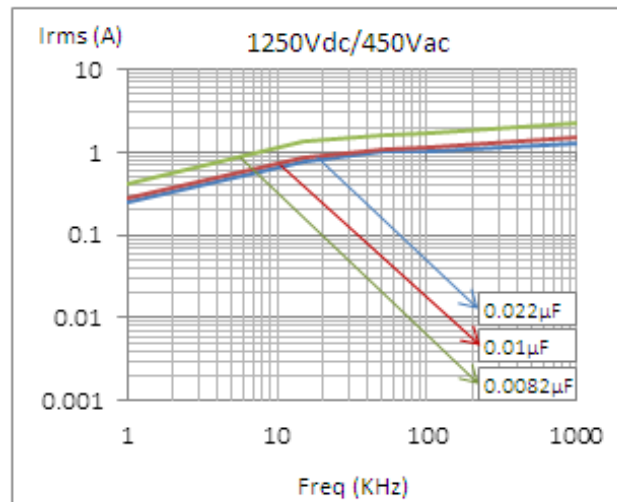

Max. Voltage (Vrms) vs. Frequency
(Sinusoidal Waveform at $T \leq 85^\circ\text{C}$)

Max. Current (Irms) vs. Frequency
(Sinusoidal Waveform at $T \leq 85^\circ\text{C}$)

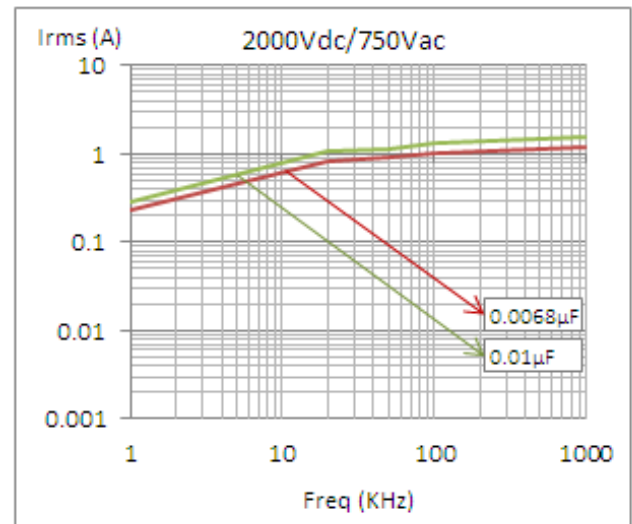
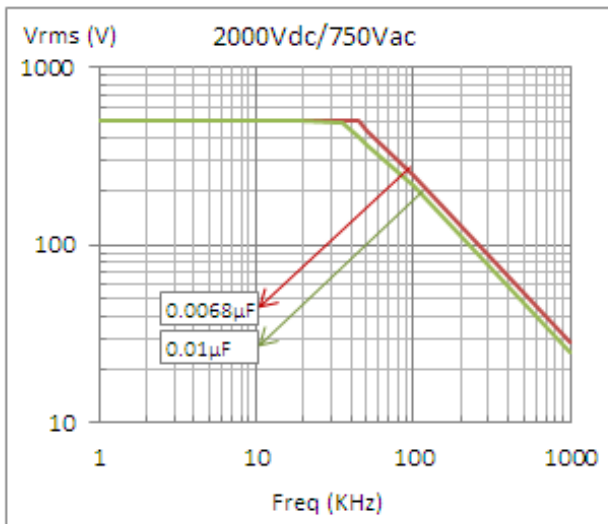
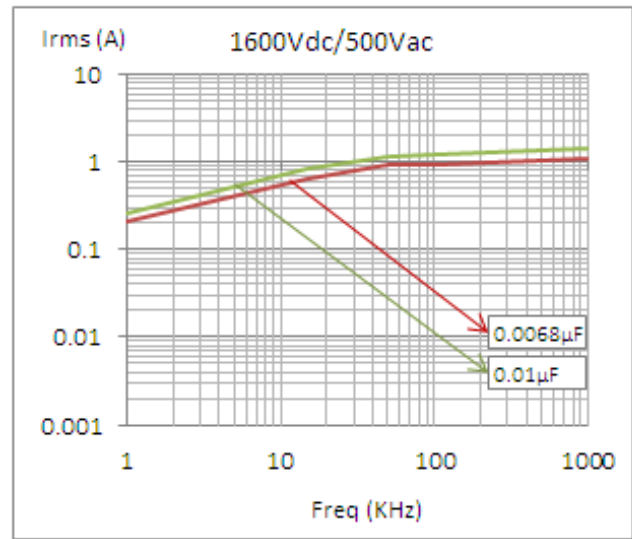
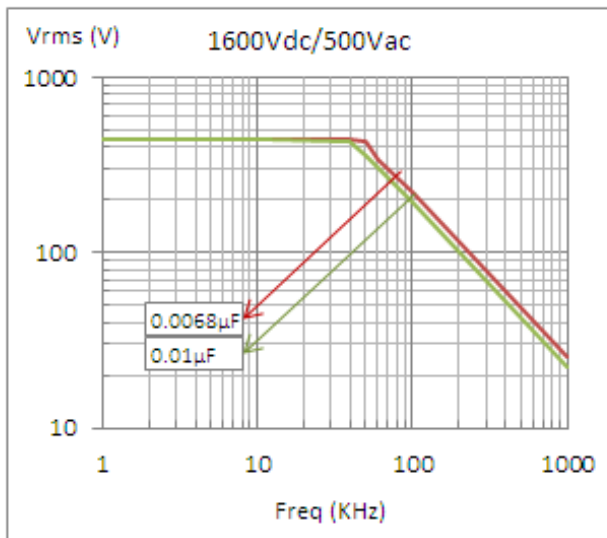

**Ordering code and packaging unit: AC Pulse & Metallized Polypropylene Film Capacitors
(PP/MPP) Dip Type Series Code 63**

Rated Voltage	Rated Capacitance μF	Dimensions (mm)					Ordering code	Packing units Bulk
		W ±0.75	H ±0.75	L ±0.75	d ±0.05	S ±0.75		
1000VDC	0.0068	6.0	10.5	19.0	0.8	15.0	63 682 +3A*^	500
400VAC	0.01	6.5	11.0	19.0	0.8	15.0	63 103 +3A*^	500
	0.1	15.0	21.5	19.0	0.8	15.0	63 104 +3A*^	500
	0.018	7.0	12.0	28.0	0.8	22.5	63 183 +3A*^	250
	0.068	10.0	15.0	28.0	0.8	22.5	63 683 +3A*^	250
	0.1	11.0	18.0	28.0	0.8	22.5	63 104 +3A*^	250
	0.022	7.5	12.5	31.0	0.8	27.5	63 223 +3A*^	250
	0.1	10.5	16.0	31.0	0.8	27.5	63 104 +3A*^	250
	0.47	19.5	29.5	31.0	0.8	27.5	63 474 +3A*^	250
1250VDC	0.0068	6.5	11.0	19.0	0.8	15.0	63 682 +3B*^	500
450VAC	0.01	6.5	11.0	19.0	0.8	15.0	63 103 +3B*^	500
	0.082	15.5	22.0	19.0	0.8	15.0	63 823 +3B*^	500
	0.0082	7.5	12.0	28.0	0.8	22.5	63 822 +3B*^	250
	0.01	8.0	13.0	28.0	0.8	22.5	63 103 +3B*^	250
	0.1	12.5	19.0	28.0	0.8	22.5	63 104 +3B*^	250
	0.022	7.5	13.0	31.0	0.8	27.5	63 222 +3B*^	250
	0.1	11.5	18.5	31.0	0.8	27.5	63 104 +3B*^	250
	0.33	19.5	29.5	31.0	0.8	27.5	63 334 +3B*^	250
1600VDC	0.0068	8.0	13.0	19.0	0.8	15.0	63 682 +3C*^	500
500VAC	0.01	9.5	15.0	19.0	0.8	15.0	63 103 +3C*^	500
	0.022	13.0	20.0	19.0	0.8	15.0	63 223 +3C*^	500
	0.0068	7.5	12.5	28.0	0.8	22.5	63 682 +3C*^	250
	0.01	7.0	12.5	28.0	0.8	22.5	63 103 +3C*^	250
	0.1	17.5	27.5	28.0	0.8	22.5	63 104 +3C*^	250
	0.022	9.0	14.0	31.0	0.8	27.5	63 223 +3C*^	250
	0.1	15.5	25.5	31.0	0.8	27.5	63 104 +3C*^	250
	0.18	21.5	31.0	31.0	0.8	27.5	63 184 +3C*^	250
2000VDC	0.0068	10.0	17.0	19.0	0.8	15.0	63 682 +3D*^	500
700VAC	0.01	12.0	19.0	19.0	0.8	15.0	63 103 +3D*^	500
	0.015	15.0	21.5	19.0	0.8	15.0	63 153 +3D*^	500
	0.0068	7.5	12.5	28.0	0.8	22.5	63 682 +3D*^	250
	0.01	8.5	13.5	28.0	0.8	22.5	63 103 +3D*^	250
	0.082	19.5	29.5	28.0	0.8	22.5	63 823 +3D*^	250
	0.0068	7.5	13.0	31.0	0.8	27.5	63 682 +3D*^	250
	0.01	8.0	13.0	31.0	0.8	27.5	63 103 +3D*^	250
	0.1	19.5	29.5	31.0	0.8	27.5	63 104 +3D*^	250

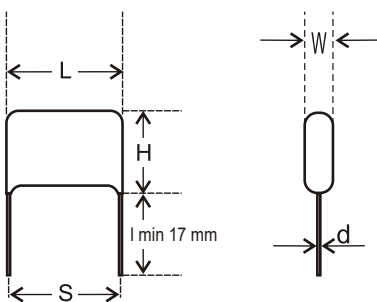

**Ordering code and packaging unit: AC Pulse & Metallized Polypropylene Film Capacitors
(PP/MPP) Box Type Series Code 68**

Rated Voltage	Rated Capacitance μF	Dimensions (mm)					Ordering code	Packing units Bulk
		W ± 0.75	H ± 0.75	L ± 0.75	d ± 0.05	S ± 0.75		
1000VDC	0.0068	5.0	11.0	18.0	0.8	15.0	68 682 +3A*^	500
400VAC	0.01	5.0	11.0	18.0	0.8	15.0	68 103 +3A*^	500
	0.082	12.0	21.0	18.0	0.8	15.0	68 823 +3A*^	500
	0.018	6.0	15.0	26.0	0.8	22.5	68 183 +3A*^	250
	0.068	8.5	17.0	26.0	0.8	22.5	68 683 +3A*^	250
	0.1	10.0	19.0	26.0	0.8	22.5	68 104 +3A*^	250
	0.022	9.0	18.0	32.0	0.8	27.5	68 223 +3A*^	250
	0.1	9.0	18.0	32.0	0.8	27.5	68 104 +3A*^	250
	0.47	20.0	30.0	32.0	0.8	27.5	68 474 +3A*^	250
1250VDC	0.0068	6.0	12.0	18.0	0.8	15.0	68 682 +3B*^	500
450VAC	0.01	6.0	12.0	18.0	0.8	15.0	68 103 +3B*^	500
	0.056	12.0	21.0	18.0	0.8	15.0	68 563 +3B*^	500
	0.0082	6.0	15.0	26.0	0.8	22.5	68 822 +3B*^	250
	0.01	7.0	16.5	26.0	0.8	22.5	68 103 +3B*^	250
	0.1	12.0	22.0	26.0	0.8	22.5	68 104 +3B*^	250
	0.022	9.0	18.0	32.0	0.8	27.5	68 222 +3B*^	250
	0.1	11.0	20.0	32.0	0.8	27.5	68 104 +3B*^	250
	0.33	21.0	34.0	32.0	0.8	27.5	68 334 +3B*^	250
1600VDC	0.0068	7.5	13.5	18.0	0.8	15.0	68 682 +3C*^	500
500VAC	0.01	8.5	17.5	18.0	0.8	15.0	68 103 +3C*^	500
	0.022	12.0	21.0	18.0	0.8	15.0	68 223 +3C*^	500
	0.0068	6.0	15.0	26.0	0.8	22.5	68 682 +3C*^	250
	0.01	6.0	15.0	26.0	0.8	22.5	68 103 +3C*^	250
	0.068	15.0	25.0	26.0	0.8	22.5	68 683 +3C*^	250
	0.022	9.0	18.0	32.0	0.8	27.5	68 223 +3C*^	250
	0.1	18.0	26.0	32.0	0.8	27.5	68 104 +3C*^	250
	0.18	21.0	34.0	32.0	0.8	27.5	68 184 +3C*^	250
2000VDC	0.0068	10.0	16.0	18.0	0.8	15.0	68 682 +3D*^	500
700VAC	0.01	12.0	21.0	18.0	0.8	15.0	68 103 +3D*^	500
	0.012	12.0	21.0	18.0	0.8	15.0	68 123 +3D*^	500
	0.0068	6.0	15.0	26.0	0.8	22.5	68 682 +3D*^	250
	0.01	7.0	16.5	26.0	0.8	22.5	68 103 +3D*^	250
	0.047	15.0	25.0	26.0	0.8	22.5	68 473 +3D*^	250
	0.0068	9.0	18.0	32.0	0.8	27.5	68 682 +3D*^	250
	0.01	9.0	18.0	32.0	0.8	27.5	68 103 +3D*^	250
	0.1	20.0	30.0	32.0	0.8	27.5	68 104 +3D*^	250

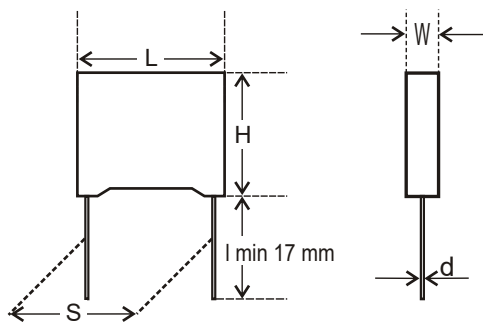

Plain Polypropylene Film Capacitors

Series Code
21, 32

Non-Inductive

Main Application

SMPS, Motor control circuits, deflection circuit in TV sets (fly back) and monitors, electronic ballast, snubber and SCR commutating circuits and applications with high voltage and high current.

Construction

Film/foil non inductive type construction with aluminum foil as electrode and PP film as dielectric coated with flame retardant epoxy resin or encased in flame retardant box.

Climatic Category

40/100/56

Rated and Maximum Operating Temperature

85°C and 100°C

Applicable Specification

IEC 384-13 and CACT approved for telecom applications.

Capacitance Value

0.0022µF-0.47 µF

Capacitance Tolerance

±1%, ±2%, ±2.5%, ±5%, ±10%

Insulation Resistance

Minimum Insulation Resistance R_{is}
(or) time constant $T = C_R \times R_{is}$

V_R
≤100 V DC

$C_R \leq 0.1 \mu F$
100 GΩ

$C_R > 0.1 \mu F$
10000s

Rated Voltage

250VDC-1000VDC

Voltage Proof

Between terminals: 2 times the rated voltage for 2 sec.

Tan δ

0.08% (maximum) at 1 kHz.

Life Test Conditions

(Loading at elevated temperature)

Loaded at 1.5 times of rated voltage at 85° C for 1000 hours.

After the Test

$\Delta C/C \leq 3\%$ of initial value.

Increase of Tan δ: ≤ 1.4 times the value measured before the test.

Insulation resistance: ≥ 50% of the value mentioned in IR chart.

Derating graph for Plain Polypropylene Film Capacitors Non-Inductive

Max. Voltage (Vrms) vs. Frequency
(Sinusoidal Waveform at $T \leq 85^\circ C$)

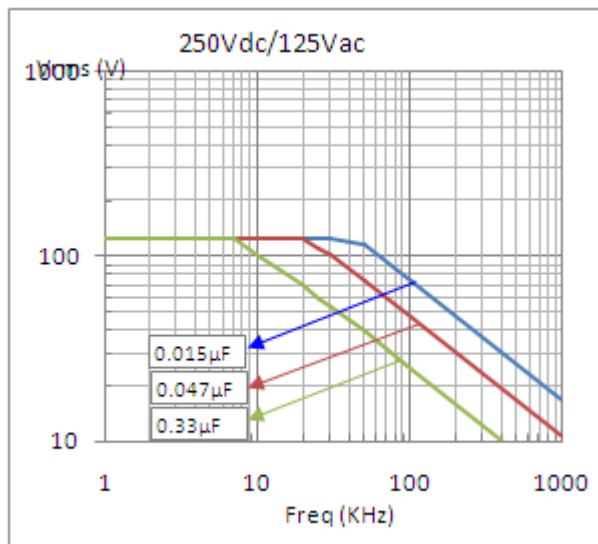

Max. Current (Irms) vs. Frequency
(Sinusoidal Waveform at $T \leq 85^\circ C$)

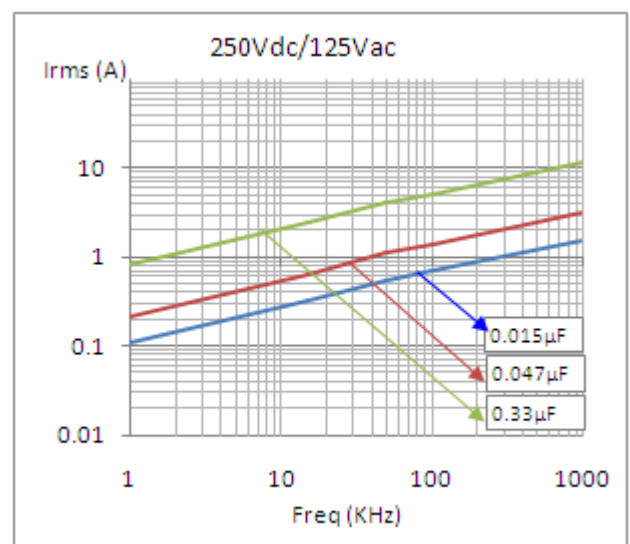

Max. Voltage (Vrms) vs. Frequency
(Sinusoidal Waveform at $T \leq 85^\circ\text{C}$)

Max. Current (Irms) vs. Frequency
(Sinusoidal Waveform at $T \leq 85^\circ\text{C}$)

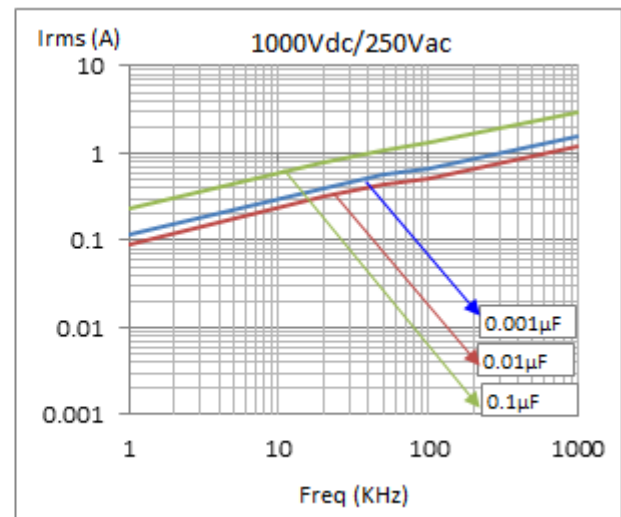
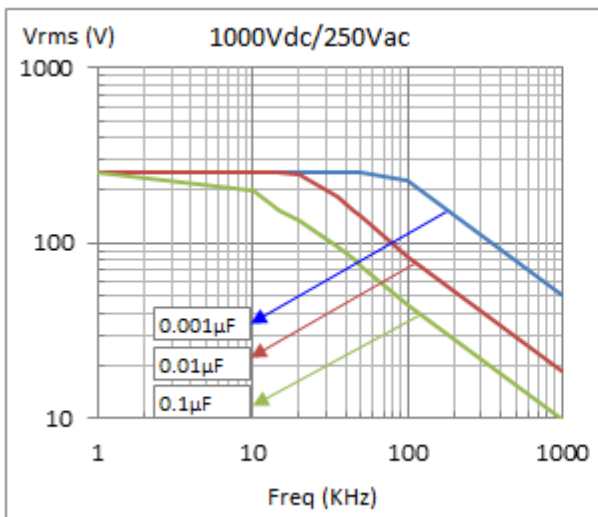
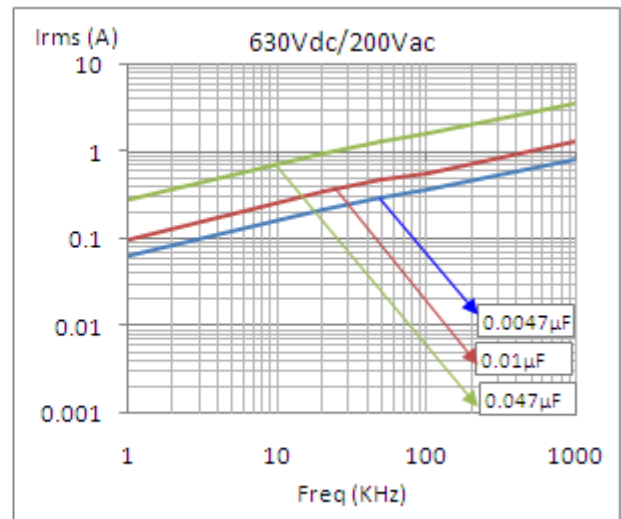
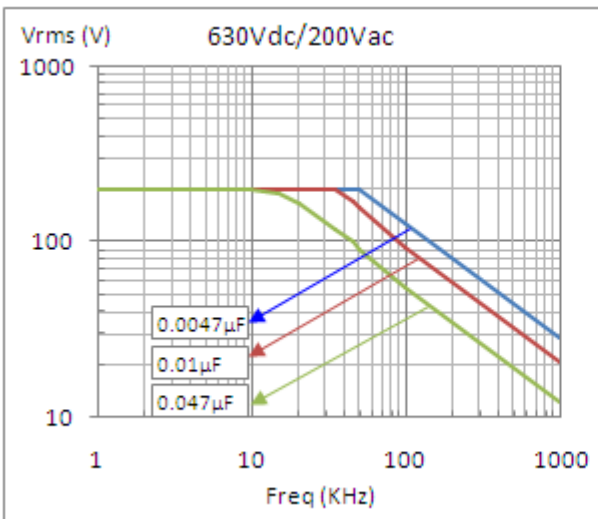
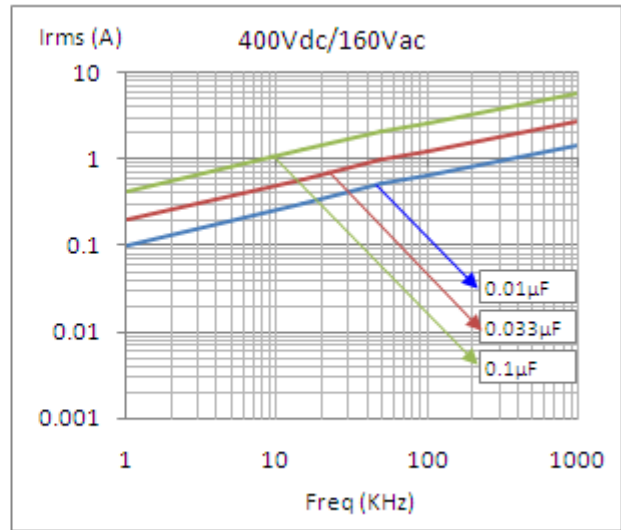
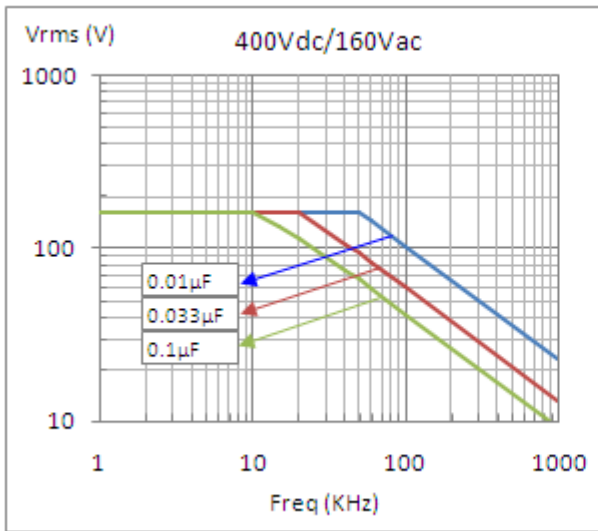

**Ordering code and packaging unit: Plain Polypropylene Film Capacitors
(Non-Inductive) Box Type Series Code 21**

Rated Voltage	Rated Cap. (µF)	Dimensions (mm)						Wt. g	Ordering code	Packing units Bulk
		W ±0.5	H ±0.5	L ±0.5	d ±0.05	S ±0.75	F ±0.5			
250VDC	0.0033	4.0	9.0	13	0.6	10.0	10.0	0.6	21 332 +2E*^	500
	0.0047	4.0	9.0	13	0.6	10.0	10.0	0.6	21 472 +2E*^	500
	0.0068	5.0	11.0	13	0.6	10.0	10.0	0.8	21 682 +2E*^	500
	0.0100	6.0	12.0	13	0.6	10.0	10.0	0.9	21 103 +2E*^	500
	0.0470	10.0	16.0	18	0.8	15.0	15.0	2.8	21 473 +2E*^	500
	0.4700	12.0	21.0	18	0.8	15.0	15.0	-	21 474 +2E*^	500
400VDC	0.0022	4.0	9.0	13	0.6	10.0	10.0	0.6	21 222 +2G*^	500
	0.0033	5.0	11.0	13	0.6	10.0	10.0	0.8	21 332 +2G*^	500
	0.0047	5.0	11.0	13	0.6	10.0	10.0	0.8	21 472 +2G*^	500
	0.0100	5.0	10.8	18	0.8	15.0	15.0	1.1	21 103 +2G*^	500
	0.0220	7.5	13.5	18	0.8	15.0	15.0	2.0	21 223 +2G*^	500
	0.0470	10.0	16.0	18	0.8	15.0	15.0	2.8	21 473 +2G*^	500
630VDC	0.0022	5.0	11.0	13	0.6	10.0	10.0	0.8	21 222 +2J*^	500
	0.0033	6.0	12.0	13	0.6	10.0	10.0	0.9	21 332 +2J*^	500
	0.0047	6.0	12.0	13	0.6	10.0	10.0	0.9	21 472 +2J*^	500
	0.0100	5.0	10.8	18	0.8	15.0	15.0	1.1	21 103 +2J*^	500
	0.0220	7.5	13.5	18	0.8	15.0	15.0	2.0	21 223 +2J*^	500
	0.1000	11.0	16.0	28	0.8	22.5	22.5	-	21 474 +2J*^	250
1000VDC	0.0010	6.0	12.0	13	0.6	10.0	10.0	-	21 102 +3A*^	500
	0.0100	6.0	12.0	18	0.8	15.0	15.0	-	21 103 +3A*^	500
	0.1000	14.0	28.0	32	0.8	27.5	27.5	-	21 104 +3A*^	250

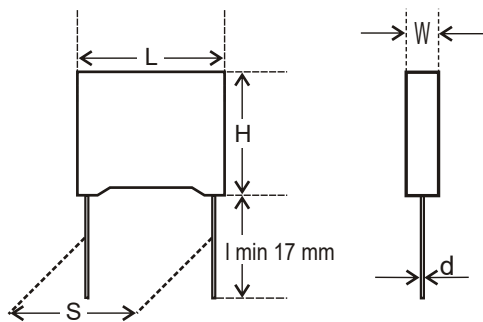

**Ordering code and packaging unit: Plain Polypropylene Film Capacitors
(Non-Inductive) Dip Type Series Code 32**

Rated Voltage	Rated Cap. (µF)	Dimensions (mm)						Wt. g	Ordering code	Packing units Bulk
		W (max)	H (max)	L (max)	d ±0.05	S ±0.75	F ±0.5			
250VDC	0.015	6.0	11.0	14	0.6	10.0	10.0	0.5	32 153 +2E*^	500
	0.022	5.5	10.5	19	0.8	15.0	15.0	0.7	32 223 +2E*^	500
	0.033	6.0	11.0	19	0.8	15.0	15.0	0.9	32 333 +2E*^	500
	0.047	6.0	13.5	19	0.8	15.0	15.0	1.2	32 473 +2E*^	500
	0.1	6.5	15.5	27	0.8	22.5	22.5	1.6	32 104 +2E*^	250
	0.22	9.0	18.0	27	0.8	22.5	22.5	1.8	32 224 +2E*^	250
	0.33	11.0	20.5	27	0.8	22.5	22.5	2.1	32 334 +2E*^	250
400VDC	0.01	6.0	13.5	19	0.8	15.0	15.0	0.5	32 103 +2G*^	500
	0.033	7.0	15.0	19	0.8	15.0	15.0	1.1	32 333 +2G*^	500
	0.047	8.0	17.0	19	0.8	15.0	15.0	1.4	32 473 +2G*^	250
	0.1	9.0	18.0	27	0.8	22.5	22.5	2.7	32 104 +2G*^	250
	0.22	11.5	21.0	32	0.8	27.5	27.5	4.5	32 224 +2G*^	250
630VDC	0.0022	5.5	10.5	14	0.6	10.0	10.0	0.7	32 222 +2J*^	500
	0.0047	6.5	13.5	14	0.6	10.0	10.0	0.9	32 472 +2J*^	500
	0.0056	5.5	12.0	19	0.8	15.0	15.0	1.2	32 682 +2J*^	500
	0.01	6.0	13.5	19	0.8	15.0	15.0	1.5	32 103 +2J*^	250
	0.022	8.0	17.0	19	0.8	15.0	15.0	2.0	32 223 +2J*^	250
	0.047	9.0	18.0	27	0.8	22.5	22.5	2.8	32 473 +2J*^	250
1000VDC	0.1	11.5	21.0	32	0.8	27.5	27.5	3.5	32 104 +2J*^	250
	0.015	8.0	15.0	19	0.8	15.0	15.0	-	32 153 +3A*^	500
	0.1	9.0	17.5	32	0.8	27.5	27.5	-	32 104 +3A*^	250
	0.47	15.5	26.0	41	1.0	37.5	37.5	-	32 474 +3A*^	100

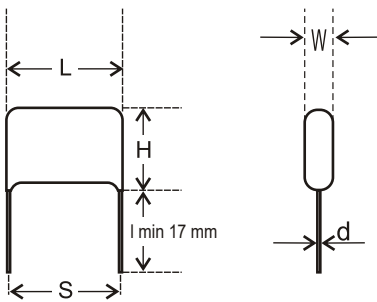

Inductive Self Healing Polypropylene Film Capacitors

Series Code
70

DPSH Series

Main Application

Blocking, bypassing, filtering, coupling and decoupling, interference suppression in low voltage application, low pulse application.

Construction

Film/foil inductive type internally series construction with aluminium foil as electrode and polypropylene film dielectric and metallized polypropylene film as connecting electrode, coated with epoxy resin.

Climatic Category

40/100/56

Rated and Maximum Operating Temperature

85°C and 100°C

Applicable Specification

IEC384-16, IEC384-17

Capacitance Value

0.0015µF -0.01µF

Capacitance Tolerance

±5%, ±10%

Insulation Resistance

Minimum Insulation Resistance R_{IS}
(or) time constant $T = C_R \times R_{IS}$
temp 20°C, relative humidity ≤ 70%)

$C_R \leq 0.33\mu F$
100000MΩ

Rated Voltage

1250VDC-2000VDC

Voltage Proof

1.6 times of rated voltage or 2 sec.

Tan δ

0.1% at 1kHz

Endurance Test

1. Test Conditions (DC)

Loaded at 1.25 times of rated DC voltage at 85° C for 1000 hours.

2. Test Conditions (AC)

Loaded at 1.25 times of rated AC voltage at 70° C for 1000 hours.

After The Test

$\Delta C/C \leq 5\%$

Increase of Tan δ: 1.4 times the value measured before the test.

Insulation Resistance: 50% of value mentioned in IR chart.

Derating graph for Inductive Self Healing Polypropylene Film Capacitors DPSH Series

Max. Voltage (Vrms) vs. Frequency
(Sinusoidal Waveform at $T \leq 85^\circ C$)

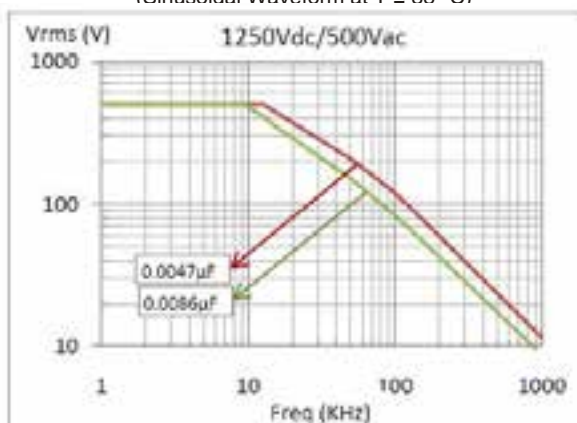

Max. Current (Irms) vs. Frequency
(Sinusoidal Waveform at $T \leq 85^\circ C$)

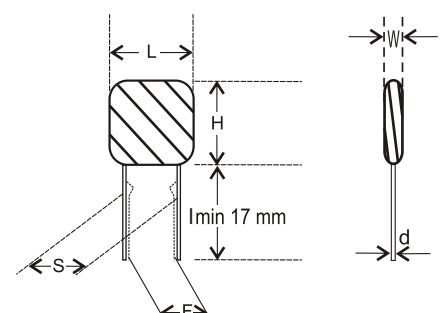
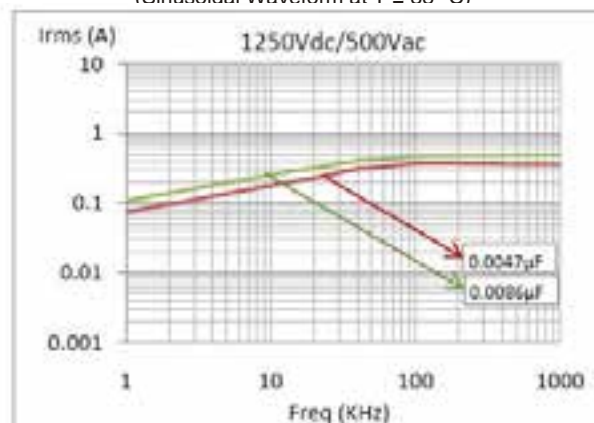

Max. Voltage (Vrms) vs. Frequency
(Sinusoidal Waveform at T ≤ 85° C)

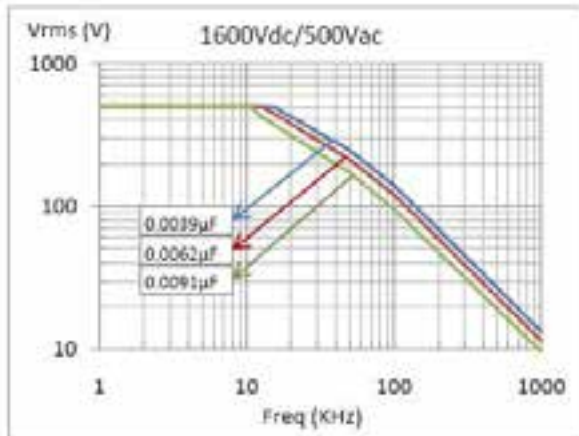

Max. Current (Irms) vs. Frequency
(Sinusoidal Waveform at T ≤ 85° C)

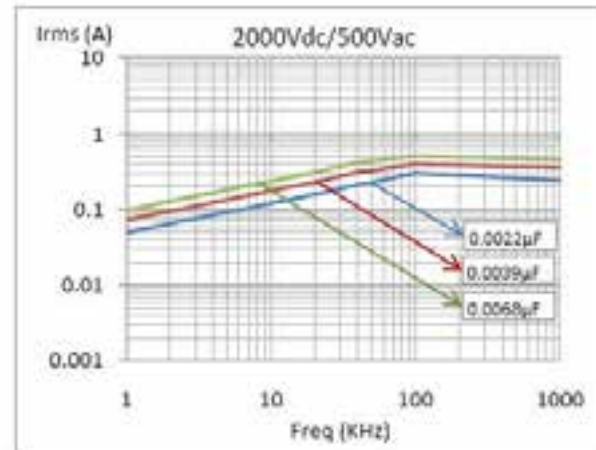
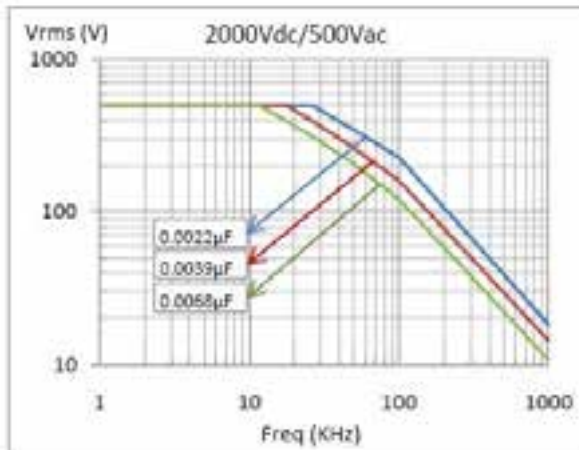
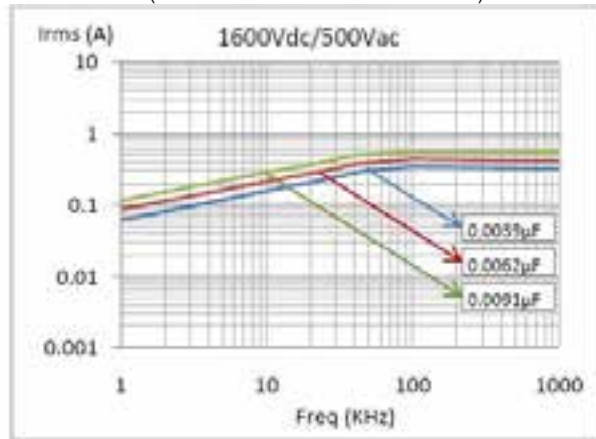

**Ordering code and packaging unit: Inductive Self Healing Polypropylene Film Capacitors
DPSH Series Series Code 70**

Rated Voltage	Rated Cap. (µF)	Dimensions (mm)				S ±0.5	DV/DT V/µs	Wt g	Ordering code	Packing units Bulk
		W max	H max	L max	d ±0.05					
1250VDC	0.0027	5.0	17.5	8.0	0.5	5.0	10000	0.500	70 272 +3B [^]	500
	0.0033	5.0	17.5	8.0	0.5	5.0	10000	0.570	70 332 +3B [^]	500
	0.0039	5.5	17.5	8.5	0.5	5.0	10000	0.680	70 392 +3B [^]	500
	0.0047	5.5	17.5	9.0	0.5	5.0	10000	0.770	70 472 +3B [^]	500
	0.0056	5.5	17.5	9.5	0.5	5.0	10000	0.820	70 562 +3B [^]	500
	0.0068	6.5	17.5	10.0	0.5	7.0	10000	0.910	70 682 +3B [^]	500
	0.0086	6.5	17.5	10.0	0.5	7.0	10000	1.070	70 862 +3B [^]	500
	0.01	7.0	17.5	10.5	0.5	7.5	10000	1.192	70 103 +3B [^]	500
1600VDC	0.0039	6.5	17.5	9.5	0.5	5.0	10000	0.860	70 392 +3C [^]	500
	0.0047	5.17	15.97	8.72	0.5	5.0	10000	0.970	70 472 +3C [^]	500
	0.0056	6.5	17.5	11.0	0.5	7.0	10000	1.070	70 562 +3C [^]	500
	0.0062	6.5	17.5	11.0	0.5	7.5	10000	1.100	70 622 +3C [^]	500
	0.0068	7.0	17.5	11.0	0.5	7.0	10000	1.140	70 682 +3C [^]	500
	0.0082	7.5	17.5	11.0	0.5	7.0	10000	1.270	70 822 +3C [^]	500
	0.0086	8.0	17.5	11.5	0.5	7.0	10000	1.340	70 862 +3C [^]	500
	0.01	8.5	18.0	12.5	0.5	7.0	10000	1.490	70 103 +3C [^]	500
2000VDC	0.0015	5.5	18.0	8.5	0.5	5.0	10000	0.550	70 152 +3D [^]	500
	0.0022	6.0	18.0	9.0	0.5	5.0	10000	0.640	70 222 +3D [^]	500
	0.0033	6.5	18.0	10.0	0.5	5.0	10000	0.820	70 332 +3D [^]	500
	0.0047	7.5	18.0	11.0	0.5	7.5	10000	1.130	70 472 +3D [^]	500
	0.0056	8.5	18.0	11.5	0.5	7.5	10000	1.240	70 562 +3D [^]	500
	0.0068	9.5	18.0	12.5	0.5	7.5	10000	1.330	70 682 +3D [^]	500
	0.0100	10.0	18.0	14.0	0.5	7.5	10000	1.740	70 103 +3D [^]	500

AC Pulse & Metallized Polypropylene Axial Film Capacitors Series Code 129, 132

PP/MPP-Tape Wrapped

Main Application

SMPS, electronic ballast, resonant capacitor, snubber application with high voltage and high current.

Construction

Series constructed polypropylene film, aluminium foil and metallized polypropylene film as internal electrodes wrapped with polyester tape filled with resin.

Climatic Category

40/100/21

Rated and Maximum Operating Temperature

85°C & 100°C

Applicable Specification

IEC 384-16

Capacitance Value Range

0.001µF-1.0µF

Rated Voltage

400VDC-1600VDC

Capacitance Tolerance

±5%, ±10%

Insulation Resistance

Between leads > 100000 MΩ

Between interconnected leads and case >100000MΩ

Voltage Proof

Between terminals: 1.6 times of rated voltage for 2 sec.

Tan δ

Frequency(kHz)	$C_R < 0.1\mu F$	$0.1\mu F \leq C_R \leq 1\mu F$
At 1	0.05%	0.08%
At 10	0.1%	0.15%
At 100	0.3%	0.5%

Life Test Conditions

(Loading at elevated temperature)

Loaded at 1.25 times the rated DC voltage at 85° C for 1000 hours.

After the Test

$\Delta C/C: \leq 10\%$ of initial value.

Increase in Tan δ: ≤ 0.004

Insulation resistance: $\geq 50\%$ of the value mentioned in IR chart.

AC & Pulse Metallized Round Axial Film Capacitors (Series Code-129)

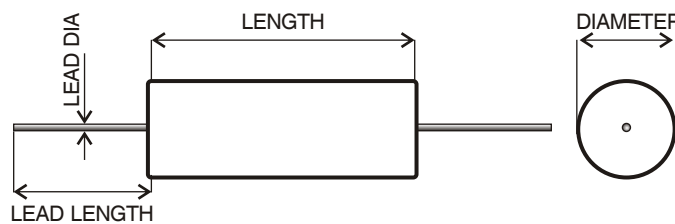

AC & Pulse Metallized Flat Axial Film Capacitors (Series Code-132)

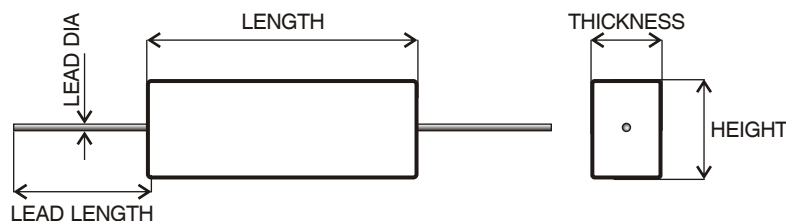

Plain Polypropylene Round Axial Film Capacitors

Series Code
97

Non-Inductive

Main Application

Oscillator, timing and LC/RC filter circuits, high frequency coupling of fast digital and analog ICs.

Construction

Film/foil inductive type construction with aluminum foil as electrode and polypropylene (PP) film as dielectric wrapped in polyester tape filled with epoxy resin.

Climatic Category

40/100/21

Rated and Maximum Operating Temperature

85°C and 100°C

Applicable Specification

IEC 384-13

Capacitance Value

0.001µF-2.2 µF

Capacitance Tolerance

±5%, ±10%

Insulation Resistance

Minimum Insulation Resistance R_{IS}
(or) time constant $T=C_R \times R_{IS}$
at 25° C, relative humidity ≤70%

Rated Voltage

100VDC-1600VDC

Voltage Proof

Between terminals: 2 times of rated voltage for 2 sec.

Tan δ

0.08% (max)

Life Test Conditions

(Loading at elevated temperature)

Loaded at 1.5 times of rated voltage at 85°C for 1000 hours.

After the Test:

$\Delta C/C$: ≤ 5% of initial value.

Tan δ: ≤ 1.4 times the value measured before the test.

Insulation resistance: ≥ 50% of the value mentioned in IR chart.

$C_R \leq 0.1 \mu F$	$C_R > 0.1 \mu F$
100000 MΩ	30000 s

Ordering code and packing units: Plain Polypropylene Round Axial Film Capacitors Non-Inductive Series Code 97

Rated Voltage	Rated Cap. (µF)	Outer Diameter (max)	Length (max)	Dimensions (mm)		Weight (g)	Ordering code
				Lead Diameter (±0.05)	Lead Length (min)		
100VDC	0.001	10.0	15	0.6	30	1.8	97 102 + 2A ^A
	0.0047	10.0	15	0.6	30	1.9	97 472 + 2A ^A
	0.01	10.0	15	0.6	30	2.0	97 103 + 2A ^A
	0.047	13.0	15	0.6	30	3.4	97 473 + 2A ^A
	0.047	10.0	21	0.8	30	2.5	97 473 + 2A ^A
	0.1	12.0	21	0.8	30	4.2	97 104 + 2A ^A
	0.22	17.0	21	0.8	30	8.0	97 224 + 2A ^A
	0.1	10.0	29	0.8	30	3.6	97 104 + 2A ^A
	0.22	13.0	29	0.8	30	6.6	97 224 + 2A ^A
	0.47	18.0	29	0.8	30	12.5	97 474 + 2A ^A
	0.1	10.0	35	0.8	30	3.5	97 104 + 2A ^A
	0.47	16.0	35	0.8	30	13.7	97 474 + 2A ^A
	1.0	22.0	35	0.8	30	22.5	97 105 + 2A ^A
	1.0	19.0	45	1.0	30	20.7	97 105 + 2A ^A
	1.5	22.5	45	1.0	30	29.8	97 155 + 2A ^A
	2.2	24.0	45	1.0	30	42.3	97 225 + 2A ^A

**Ordering code and packing units: Plain Polypropylene Round Axial Film Capacitors
 Non-Inductive Series Code 97 (continued)**

Rated Voltage	Rated Cap. (µF)	Outer Diameter (max)	Length (max)	Dimensions (mm)		Weight (g)	Ordering code
				Lead Diameter (±0.05)	Lead Length (min)		
250VDC	0.001	10.0	15	0.6	30	1.8	97 102 + 2E *^
	0.0047	10.0	15	0.6	30	1.9	97 472 + 2E *^
	0.01	10.0	15	0.6	30	2.0	97 103 + 2E *^
	0.047	13.0	15	0.6	30	3.4	97 473 + 2E *^
	0.033	10.0	21	0.8	30	2.5	97 333 + 2E *^
	0.1	14.0	21	0.8	30	5.6	97 104 + 2E *^
	0.22	20.0	21	0.8	30	10.7	97 224 + 2E *^
	0.1	12.0	29	0.8	30	4.6	97 104 + 2E *^
	0.22	16.0	29	0.8	30	8.6	97 224 + 2E *^
	0.47	22.0	29	0.8	30	16.6	97 474 + 2E *^
	0.1	11.0	35	0.8	30	4.4	97 104 + 2E *^
	0.47	19.0	35	0.8	30	15.4	97 474 + 2E *^
	1.0	26.0	35	0.8	30	30.2	97 105 + 2E *^
	1.0	22.0	45	1.0	30	27.5	97 105 + 2E *^
	1.5	26.0	45	1.0	30	39.6	97 155 + 2E *^
400VDC	0.001	10.0	15	0.6	30	1.8	97 102 + 2G *^
	0.0047	10.0	15	0.6	30	1.9	97 472 + 2G *^
	0.01	12.5	15	0.6	30	3.0	97 103 + 2G *^
	0.01	10.0	21	0.8	30	2.2	97 103 + 2G *^
	0.047	14.0	21	0.8	30	4.6	97 473 + 2G *^
	0.1	18.0	21	0.8	30	8.5	97 104 + 2G *^
	0.068	11.0	29	0.8	30	3.8	97 683 + 2G *^
	0.22	16.5	29	0.8	30	9.5	97 224 + 2G *^
	0.47	22.5	29	0.8	30	18.4	97 474 + 2G *^
	0.1	11.5	35	0.8	30	4.7	97 104 + 2G *^
	0.22	16.5	35	0.8	30	11.0	97 224 + 2G *^
	0.47	22.5	35	0.8	30	21.1	97 474 + 2G *^
	0.68	22.0	45	1.0	30	26.2	97 684 + 2G *^
	1.0	26.0	45	1.0	30	37.1	97 105 + 2G *^
	630VDC	0.001	10.0	15	0.6	30	1.7
0.0047		10.0	15	0.6	30	2.0	97 472 + 2J *^
0.01		11.0	15	0.6	30	2.5	97 103 + 2J *^
0.01		10.0	21	0.8	30	2.2	97 103 + 2J *^
0.033		13.5	21	0.8	30	4.3	97 333 + 2J *^
0.068		17.0	21	0.8	30	7.5	97 683 + 2J *^
0.047		12.0	29	0.8	30	4.7	97 473 + 2J *^
0.1		16.0	29	0.8	30	8.4	97 104 + 2J *^
0.33		22.5	29	0.8	30	21.5	97 334 + 2J *^
0.1		14.0	35	0.8	30	7.9	97 104 + 2J *^
0.22		19.5	35	0.8	30	15.1	97 224 + 2J *^
0.47		22.5	45	0.8	30	26.8	97 474 + 2J *^

**Ordering code and packing units: Plain Polypropylene Round Axial Film Capacitors
Non-Inductive Series Code 97 (continued)**

Rated Voltage	Rated Cap. (µF)	Dimensions (mm)				Weight (g)	Ordering code
		Outer Diameter (max)	Length (max)	Lead Diameter (±0.05)	Lead Length (min)		
1000VDC	0.001	10.0	15	0.6	30	1.7	97 102 + 3A ^A
	0.0022	10.0	15	0.6	30	2.0	97 222 + 3A ^A
	0.0033	12.0	15	0.6	30	2.6	97 332 + 3A ^A
	0.0047	10.0	21	0.8	30	2.3	97 472 + 3A ^A
	0.01	11.0	21	0.8	30	2.9	97 103 + 3A ^A
	0.022	11.5	29	0.8	30	4.0	97 223 + 3A ^A
	0.033	13.5	29	0.8	30	5.3	97 333 + 3A ^A
	0.068	17.0	29	0.8	30	9.2	97 683 + 3A ^A
	0.033	11.0	35	0.8	30	4.9	97 333 + 3A ^A
	0.1	17.5	35	0.8	30	11.3	97 104 + 3A ^A
	0.22	23.5	35	0.8	30	22.1	97 224 + 3A ^A
	0.1	15.0	45	1.0	30	10.5	97 104 + 3A ^A
	0.22	20.0	45	1.0	30	20.1	97 104 + 3A ^A
	1250VDC	0.001	10.0	15	0.6	30	1.7
0.0022		12.0	15	0.6	30	2.5	97 222 + 3B ^A
0.0047		10.0	21	0.8	30	2.3	97 472 + 3B ^A
0.01		12.5	21	0.8	30	3.7	97 103 + 3B ^A
0.022		16.5	21	0.8	30	6.6	97 223 + 3B ^A
0.022		13.0	29	0.8	30	5.0	97 223 + 3B ^A
0.033		15.0	29	0.8	30	6.7	97 333 + 3B ^A
0.068		17.0	29	0.8	30	9.2	97 683 + 3B ^A
0.033		11.0	35	0.8	30	4.9	97 333 + 3B ^A
0.1		17.5	35	0.8	30	11.3	97 104 + 3B ^A
0.22		23.5	35	0.8	30	22.1	97 224 + 3B ^A
0.1		15.0	45	1.0	30	10.5	97 104 + 3B ^A
0.22		20.0	45	1.0	30	20.1	97 104 + 3B ^A
1600VDC		0.001	10.5	15	0.6	30	1.9
	0.0022	10.0	21	0.8	30	2.0	97 222 + 3C ^A
	0.0047	11.0	21	0.8	30	2.7	97 472 + 3C ^A
	0.01	14.0	21	0.8	30	4.5	97 103 + 3C ^A
	0.022	13.0	29	0.8	30	5.8	97 223 + 3C ^A
	0.033	15.0	29	0.8	30	7.7	97 333 + 3C ^A
	0.033	13.5	35	0.8	30	6.2	97 333 + 3C ^A
	0.047	17.0	35	0.8	30	10.2	97 473 + 3C ^A
	0.1	22.5	35	0.8	30	19.0	97 104 + 3C ^A
	0.1	19.0	45	1.0	30	17.0	97 104 + 3C ^A
	0.22	26.5	45	1.0	30	33.3	97 224 + 3C ^A
0.33	31.0	45	1.0	30	47.7	97 224 + 3C ^A	

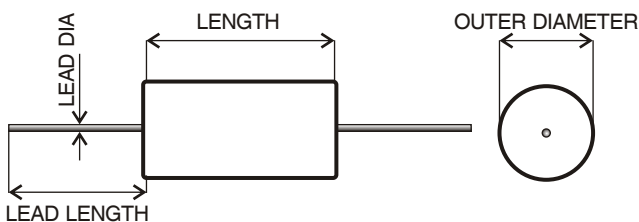

Interference Suppression Capacitors

Series Code
07

(ENEC Approved) Class X2

Main Application

Across the line application for Interference suppression.

Construction

Low inductive cell of metallized polypropylene film encased in flame retardant grade UL94 V-0 box potted with flame retardant UL94 V-0 epoxy resin.

Climatic Category

40/110/56/B

Maximum Operating Temperature

110° C

Applicable Specification

IEC384-14

Capacitance Value

0.01 μF-10 μF

Capacitance Tolerance

±10%, ±20%

Insulation Resistance

Minimum Insulation Resistance R_{IS}
(or) time constant $T = C_R \times R_{IS}$
at 25° C, relative humidity ≤65%

$C_R \leq 0.33 \mu F$
> 15,000 MΩ

$C_R > 0.33 \mu F$
>5000s

Rated Voltage

310VAC

Voltage Proof

4.3 times of the rated voltage value, DC voltage for 2 sec.

Tan δ

0.1% (max.) at 1 kHz

Life Test Conditions

(Loading at elevated temperature)

Loaded at 1.25 times of rated voltage at 110° C for 1000 hours with once per hour 1000 V (RMS) via 47 Ω ±5% resistor for 0.1 second.

After the Test

$\Delta C/C \leq 10\%$.

Increase of Tan δ: ≤ 0.008 , $C_R \leq 1 \mu F$; ≤ 0.005 , $C_R > 1 \mu F$;
Insulation resistance: > 50% of the initial value.

Safety Approval X2	Voltage	Value	Certificate Numbers
EN 60384-14:2005 (ENEC) (= IEC 60384-14:2013 ed-4)	310VAC	0.01μF to 10μF	2017076
CB Test Certificate			



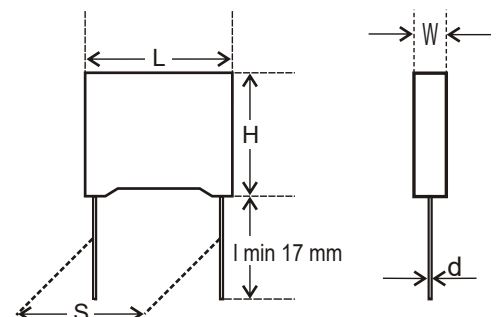

**Ordering code and packing units: Interference Suppression Capacitors
(ENEC Approved) Class X2 Series Code 07**

Rated Voltage	Rated Cap. (µF)	Dimensions (mm)					DV/DT V/µs	Ordering code	Packing Bulk
		W ±0.5	H ±0.5	L ±0.5	d ±0.02	S ±0.5			
310VAC	0.01	5.0	10.0	13.0	0.6	10.0	350.0	07 103 +05* ^	500
	0.022	5.0	11.0	13.0	0.6	10.0	400.0	07 223 +05* ^	500
	0.022	4.5	10.0	18.0	0.8	15.0	400.0	07 223 +05* ^	250
	0.047	5.5	10.5	10.0	0.6	7.5	400.0	07 473 +05* ^	500
	0.047	6.0	12.0	13.0	0.6	10.0	400.0	07 473 +05* ^	500
	0.047	5.0	10.0	18.0	0.8	15.0	400.0	07 473 +05* ^	250
	0.068	6.0	12.0	10.0	0.6	7.5	400.0	07 683 +05* ^	500
	0.068	6.0	12.0	13.0	0.6	10.0	400.0	07 683 +05* ^	500
	0.068	5.5	11.0	18.0	0.8	15.0	400.0	07 683 +05* ^	250
	0.1	7.5	13.5	10.0	0.6	7.5	400.0	07 104 +05* ^	500
	0.1	6.0	12.0	13.0	0.6	10.0	400.0	07 104 +05* ^	500
	0.1	7.0	11.0	18.0	0.8	15.0	400.0	07 104 +05* ^	250
	0.15	7.5	13.0	13.0	0.6	10.0	400.0	07 154 +05* ^	500
	0.15	6.0	12.0	18.0	0.8	15.0	400.0	07 154 +05* ^	250
	0.15	5.0	11.0	26.0	0.8	22.5	400.0	07 154 +05* ^	150
	0.22	7.0	15.0	13.0	0.6	10.0	400.0	07 224 +05* ^	500
	0.22	9.0	16.5	18.0	0.8	15.0	400.0	07 224 +05* ^	250
	0.22	6.0	13.5	26.0	0.8	22.5	400.0	07 224 +05* ^	150
	0.33	8.5	14.0	15.0	0.6	10.0	400.0	07 334 +05* ^	500
	0.33	8.0	15.5	18.0	0.8	15.0	400.0	07 334 +05* ^	250
	0.33	8.5	14.5	26.0	0.8	22.5	400.0	07 334 +05* ^	150
	0.47	10.0	20.0	12.5	0.6	10.0	400.0	07 474 +05* ^	500
	0.47	8.0	15.5	18.0	0.8	15.0	400.0	07 474 +05* ^	250
	0.47	7.5	17.0	26.0	0.8	22.5	400.0	07 474 +05* ^	150
	0.47	7.0	15.5	31.0	0.8	27.5	400.0	07 474 +05* ^	100
	0.68	10.0	17.0	18.0	0.8	15.0	400.0	07 684 +05* ^	250
	0.68	8.0	17.0	26.0	0.8	22.5	400.0	07 684 +05* ^	150
	0.68	8.5	18.0	31.0	0.8	27.5	400.0	07 684 +05* ^	100
	1.0	11.0	20.0	18.0	0.8	15.0	400.0	07 105 +05* ^	250
	1.0	11.0	19.5	26.0	0.8	22.5	400.0	07 105 +05* ^	150
1.0	10.5	19.5	31.0	0.8	27.5	400.0	07 105 +05* ^	100	
1.5	11.0	21.5	26.0	0.8	22.5	400.0	07 155 +05* ^	150	
1.5	15.0	25.0	31.0	0.8	27.5	400.0	07 155 +05* ^	100	
2.2	14.0	24.0	26.0	0.8	22.5	400.0	07 225 +05* ^	150	
2.2	18.0	30.0	31.0	0.8	27.5	400.0	07 225 +05* ^	100	
3.3	17.5	26.0	31.0	0.8	27.5	400.0	07 335 +05* ^	100	
3.3	16.0	27.0	41.5	1.0	37.5	400.0	07 335 +05* ^	50	
4.7	20.0	30.5	31.0	0.8	27.5	400.0	07 475 +05* ^	100	
4.7	21.0	32.0	42.0	1.0	37.5	400.0	07 475 +05* ^	50	
6.8	25.0	35.5	41.5	1.0	37.5	400.0	07 685 +05* ^	50	
10.0	28.5	41.5	41.5	1.0	37.5	400.0	07 106 +05* ^	50	

Interference Suppression Capacitors

Series Code
20

(UL Approved) Class X2

Main Application

Across the line application for Interference suppression.

Construction

Low inductive cell of metallized polypropylene film encased in flame retardant grade UL 94 V-0 box.

Climatic Category

40/105/56/B

Maximum Operating Temperature

105° C

Applicable Specification

IEC384-14

Capacitance Value

0.0047μF-10μF

Capacitance Tolerance

±10%, ±20%

Rated Voltage

275VAC & 310VAC

Voltage Proof

2100VDC for 2 sec.

Tan δ

0.1% (max) at 1 kHz.

Life Test Conditions

(Loading at elevated temperature)

Loaded at 1.25 times of rated voltage at 105°C for 1000 hours with once per hour 1000V(RMS) via 47 Ω±5% resistor for 0.1 second.

After the test

ΔC/C: ≤ 10%.

ΔTan δ: 0.008, $C_R \leq 1\mu F$;

0.005, $C_R > 1\mu F$; at 10kHz.

Insulation resistance: > 50% of the initial value.

Insulation Resistance

Minimum Insulation Resistance R_{IS}
(or) time constant $T = C_R \times R_{IS}$
at 25° C, relative humidity ≤65%

$C_R \leq 0.33\mu F$
> 15000 MΩ

$C_R > 0.33\mu F$
>5000s

Safety Approval X2	Voltage	Value	Certificate Number
UL 1414	275/310VAC	0.0047μF to 10μF	E253651

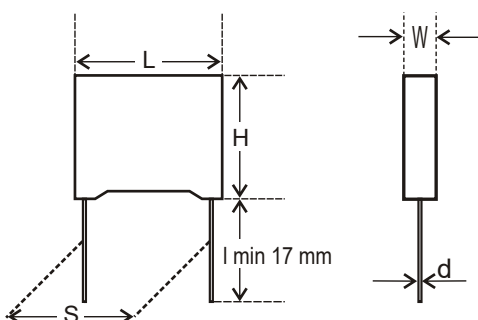

**Ordering code and packing units: Interference Suppression Capacitors
(UL Approved) Class X2 Series Code 20**

Rated Voltage	Rated Cap. (µF)	Dimensions (mm)					DV/DT V/µs	Ordering code	Packing Bulk
		W ±0.5	H ±0.5	L ±0.5	d ±0.02	S ±0.5			
275VAC	0.0047	6.0	10.0	11.0	0.60	7.5	400	20 472 +03*^	500
	0.0047	5.0	9.0	13.0	0.60	10.0	350	20 472 +03*^	500
	0.0100	5.0	9.0	10.0	0.60	7.5	400	20 103 +03*^	500
	0.0100	5.0	9.0	13.0	0.60	10.0	350	20 103 +03*^	500
	0.0100	4.5	9.0	18.0	0.80	15.0	250	20 103 +03*^	500
	0.0470	5.5	10.5	10.0	0.60	7.5	400	20 473 +03*^	500
	0.0470	7.0	13.0	13.0	0.60	10.0	350	20 473 +03*^	500
	0.0470	4.5	9.5	18.0	0.80	15.0	250	20 473 +03*^	500
	0.1000	7.5	13.5	10.0	0.60	7.5	400	20 104 +03*^	500
	0.1000	5.5	11.5	13.0	0.60	10.0	350	20 104 +03*^	500
	0.1000	5.0	10.0	18.0	0.80	15.0	250	20 104 +03*^	500
	0.4700	10.0	20.0	12.5	0.80	10.0	350	20 474 +03*^	500
	0.4700	9.0	18.0	18.0	0.80	15.0	250	20 474 +03*^	500
	0.4700	6.5	14.5	26.0	0.80	22.5	150	20 474 +03*^	250
	0.4700	6.0	13.5	31.0	0.80	27.5	100	20 474 +03*^	100
	0.6800	11.0	18.5	18.0	0.80	15.0	250	20 684 +03*^	500
	0.6800	7.5	15.0	26.0	0.80	22.5	150	20 684 +03*^	250
	0.6800	6.5	15.5	31.0	0.80	27.5	100	20 684 +03*^	100
	1.0000	10.5	21.0	18.0	0.80	15.0	250	20 105 +03*^	500
	1.0000	12.0	22.0	26.0	0.80	22.5	150	20 105 +03*^	250
1.0000	8.0	17.0	31.0	0.80	27.5	100	20 105 +03*^	100	
4.7000	19.0	32.5	31.0	1.00	27.5	100	20 475 +03*^	100	
4.7000	21.0	32.0	42.0	1.00	37.5	80	20 475 +03*^	50	
6.8000	25.0	35.5	41.5	1.00	37.5	80	20 685 +03*^	50	
10.0000	31.0	43.0	42.0	1.00	37.5	80	20 106 +03*^	50	
310VAC	0.0047	5.0	9.0	10.0	0.6	7.5	400	20 472 +05* ^	500
	0.0047	5.0	9.0	13.0	0.6	10.0	350	20 472 +05* ^	500
	0.0100	5.0	9.0	10.0	0.6	7.5	400	20 103 +05* ^	500
	0.0100	5.0	9.0	13.0	0.6	10.0	350	20 103 +05* ^	500
	0.0470	7.0	13.0	13.0	0.6	10.0	350	20 473 +05* ^	500
	0.0470	4.5	9.5	18.0	0.6	15.0	250	20 473 +05* ^	500
	0.1000	7.0	13.0	13.0	0.6	10.0	350	20 104 +05* ^	500
	0.1000	6.0	12.0	18.0	0.8	15.0	250	20 104 +05* ^	500
	0.2200	8.5	14.5	18.0	0.8	15.0	250	20 224 +05* ^	500
	0.2200	6.0	15.0	26.0	0.8	22.5	150	20 224 +05* ^	500
	0.3300	10.0	17.5	18.0	0.8	15.0	250	20 334 +05* ^	500
	0.3300	7.0	17.0	26.0	0.8	22.5	150	20 334 +05* ^	500
	0.8200	11.0	20.0	26.0	0.8	22.5	150	20 824 +05* ^	250
	1.0000	12.0	22.0	26.0	0.8	22.5	150	20 105 +05* ^	250
	1.2000	15.0	24.0	32.0	0.8	37.5	80	20 125 +05* ^	250
	4.7000	20.0	31.0	41.5	0.8	37.5	80	20 475 +05* ^	100
10.0000	28.0	41.5	41.5	0.8	37.5	80	20 106 +05* ^	50	

Interference Suppression Capacitors

Series Code
33

Safety Capacitors – Class Y2

Main Application

Ground to line application for Interference suppression.

Construction

Low inductive cell of metallized polypropylene film encased in flame retardant box potted with flame retardant epoxy.

Climatic Category

40/105/56/B

Applicable Specification

IEC 384-14

Capacitance Value

0.001 μ F-0.033 μ F

Rated Voltage

305VAC

Capacitance Tolerance

$\pm 10\%$, $\pm 20\%$

Insulation Resistance

Minimum Insulation Resistance R_{IS}
(or) time constant $T = C_R \times R_{IS}$
at 25° C, relative humidity $\leq 65\%$

$C_R \leq 0.33\mu F$
 $> 30,000 M\Omega$

$C_R > 0.33\mu F$
5000s

Voltage Proof

2100 VDC for 2 sec.

Tan δ

0.1% (max) at 1 kHz.

Life Test Conditions

(Loading at elevated temperature)

Loaded at 1.25 times of rated voltage at 85 °C for 1000 hours. Once per hour; 1000 V (RMS) via resistor of 47 Ω $\pm 5\%$ for 0.1 sec.

After the Test:

$\Delta C/C \leq 10\%$.

Increase of Tan $\delta \leq 0.005$, $C_R \leq 1\mu F$

Insulation resistance: $\geq 50\%$ of the value mentioned in IR chart.

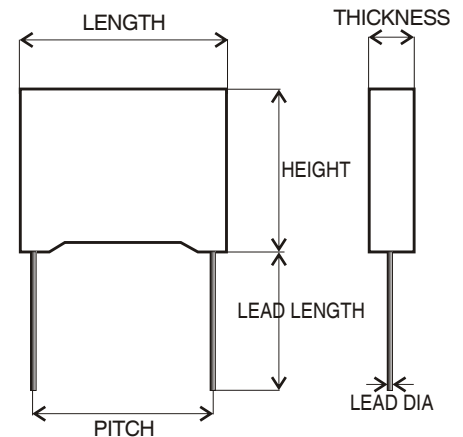

Ordering code and packaging units: Interference Suppression Capacitors Safety Capacitors – Class Y2 Series Code 33

Rated Voltage	Rated Cap. μF	Dimensions (mm)							Wt. g	Ordering Code	Packing Units Bulk
		W ± 0.5	H ± 0.5	L ± 0.5	d ± 0.05	S ± 1.0	F ± 0.5	DV/DT V/ μs			
305VAC	0.0010	4.0	9.0	13	0.6	10	10	200	0.6	33 102 +04 [^]	1000
	0.0015	4.0	9.0	13	0.6	10	10	200	0.6	33 152 +04 [^]	1000
	0.0022	4.0	9.0	13	0.6	10	10	200	0.6	33 222 +04 [^]	1000
	0.0033	5.0	11.0	13	0.6	10	10	200	0.9	33 332 +04 [^]	1000
	0.0047	6.0	12.0	13	0.6	10	10	200	1.0	33 472 +04 [^]	1000
	0.0068	6.0	12.0	13	0.6	10	10	200	1.0	33 682 +04 [^]	1000
	0.0068	5.0	11.0	18	0.8	15	15	200	1.2	33 682 +04 [^]	1000
	0.0100	5.0	11.0	18	0.8	15	15	200	1.2	33 103 +04 [^]	1000
	0.0150	6.0	13.5	18	0.8	15	15	200	1.4	33 153 +04 [^]	1000
	0.0220	7.5	13.5	18	0.8	15	15	200	1.9	33 223 +04 [^]	1000
0.0330	8.5	14.5	18	0.8	15	15	200	2.6	33 333 +04 [^]	1000	

Interference Suppression Capacitors

Series Code
133

Safety Capacitors – Class Y2

Main Application

Standard line bypass (between line and ground) applications, line bypass application for continuous operation.

Construction

Film/foil inductive type construction with aluminum foil as electrode and PP film as dielectric coated with flame retardant epoxy powder.

Climatic Category

40/100/56

Applicable Specification

IEC 384-14

Capacitance Value

0.00022 μ F-0.0068 μ F

Rated Voltage

305VAC

Capacitance Tolerance

$\pm 10\%$, $\pm 20\%$

Insulation Resistance

Minimum Insulation Resistance R_{IS}
(or) time constant $T = C_R \times R_{IS}$
at 25° C, relative humidity $\leq 65\%$

$C_R \leq 0.33\mu F$
 $> 30,000 M\Omega$

$C_R > 0.33\mu F$
 $> 10,000 s$

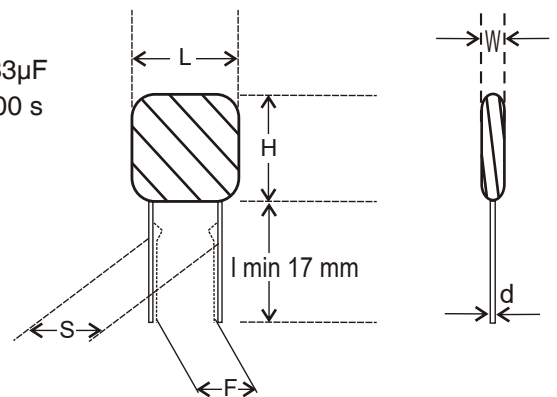

Voltage Proof

Between terminals 3000VDC for 2 sec., (Random sampling test) (destructive test): 2600 VAC for 60 sec. Voltage proof of coating (destructive test): 2600 VAC for 60 sec.

Tan δ

0.001 (maximum) at 1 kHz.

Life Test Conditions

(Loading at elevated temperature)

Loaded at 1.7 times of rated voltage at 85 °C for 1000 hours. Once per hour; 0.1 sec. 1000 V (RMS) via resistor of $47\Omega \pm 5\%$.

After the Test

$\Delta C/C \leq 10\%$.

Increase in Tan $\delta \leq 0.008$, $C_R \leq 1\mu F$

Insulation resistance: $\geq 50\%$ of the value mentioned in IR chart.

Ordering code and packaging units: Interference Suppression Capacitors Safety Capacitors – Class Y2 Series Code 133

Rated Voltage	Rated Cap. μF	Dimensions (mm) Maximum					DV/DT $V/\mu s$	Wt. g	Ordering code	Packing Units	
		W	H	L	d ± 0.05	S ± 0.5				Bulk	Ammo
305VAC	0.00022	3.5	8.0	14	0.5	5.0	10000	0.60	133 221 +04* ^	2000	4500
	0.00080	5.5	10.0	15	0.5	5.0	10000	0.80	133 801 +04* ^	2000	4500
	0.00100	5.5	10.5	15	0.5	5.0	10000	0.90	133 102 +04* ^	2000	4500
	0.00150	6.0	12.0	15	0.5	7.5	10000	1.00	133 152 +04* ^	2000	4500
	0.00220	7.0	13.0	15	0.5	7.5	10000	1.30	133 222 +04* ^	2000	4500
	0.00330	8.0	14.0	15	0.5	7.5	10000	1.65	133 332 +04* ^	2000	4500
	0.0047	9.0	16.0	15	0.5	10.0	10000	2.00	133 472 +04* ^	2000	4500
	0.0068	10.0	17.5	15	0.5	10.0	10000	2.60	133 682 +04* ^	2000	4500

Metallized Polyester Film Capacitors

Series Code
57, 81

Economic Type Fan Regulator Capacitors (MPET-EC)

Main Application

Mainly used in switch type fan regulators.

Construction

Low inductive cell of metallized polyester film coated with flame retardant grade epoxy powder.

Climatic Category

40/85/21

Maximum Operating Temperature

85°C

Capacitance Value

1.0µF-6.8µF

Capacitance Tolerance

±5%, ±10%

Rated Voltage

250VAC

Voltage Proof

Between the terminals: 640VDC for 2 sec.

Tan δ

0.001 (max) at 1 kHz.

Insulation Resistance

(Minimum insulation resistance) R_{IS} measured at 100VDC for 1 minute.

(or) time constant $T = C_R \times R_{IS} > 2500$ s

(at 25° C, relative humidity ≤ 70%)

Life Test Conditions

1. Endurance Test

Loaded at 1.1 times of rated voltage at 70°C for 500 hours.

After the Test

$\Delta C/C$: ≤ 5% of initial value

Increase of Tan δ: ≤ 0.004 of initial value at 1 kHz.

Insulation Resistance: 50% of the value mentioned in IR chart.

2. Switching Test

20,000 cycles of 4 step / 5 step switch type fan regulator. (Input supply: 240 VAC, Load: Fan motor.)

After the Test

$\Delta C/C$: ≤ 5% of initial value.

Increase of Tan δ: ≤ 0.004 of initial value at 1 kHz.

Insulation Resistance: 50% of the value mentioned in IR chart.

3. Lot to Lot Test

Loaded at 380 VAC at ambient temperature for 2 hours.

After the Test

$\Delta C/C$: ≤ 10% of initial value.

Increase of Tan δ: ≤ 0.004 of initial value at 1 kHz.

Insulation Resistance: 50% of the value mentioned in IR chart.

Ordering code and packing units: Metallized Polyester Film Capacitors Economic Type Fan Regulator Capacitors MPET-EC Series Code 57, 81

Rated Voltage	Rated Cap. (µF)	Dimensions (mm)					Ordering Code	Packing Units Bulk
		W (max)	H (max)	L (max)	d (±0.05)	S (±1.0)		
250Vac	1.0	6.5	15.5	31	0.8	27.5	57/81 105 + 02 *^	250
	1.5	7.5	16.5	31	0.8	27.5	57/81 155 + 02 *^	250
	2.2	8.5	18.5	31	0.8	27.5	57/81 225 + 02 *^	250
	2.5	9.5	19.5	31	0.8	27.5	57/81 255 + 02 *^	250
	3.3	8.5	22.5	31	0.8	27.5	57/81 335 + 02 *^	250
	4.0	12.0	22.5	31	0.8	27.5	57/81 405 + 02 *^	250
	4.3	12.5	22.5	31	0.8	27.5	57/81 435 + 02 *^	250
	4.6	13.5	23.5	31	0.8	27.5	57/81 465 + 02 *^	250
	5.5	14.0	24.5	31	0.8	27.5	57/81 555 + 02 *^	250
	6.8	14.5	27.0	31	0.8	27.5	57/81 685 + 02 *^	250

Note: Series code 57 indicates capacitor in brown colour and series code 81 indicates orange colour.

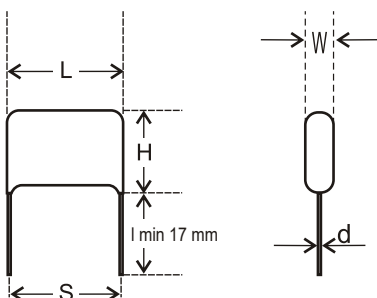

Metallized Polyester Film Capacitors

Series Code
77, 82, 83

Economic Type Fan Regulator Capacitors (MPET-EC-Ultima)

Main Application

Mainly used in switch type fan regulators.

Construction

Low inductive cell of metallized polyester film with internal fuses coated with flame retardant epoxy resin.

Climatic Category

40/85/21

Maximum Operating Temperature

85°C

Capacitance Value

1.0µF-4.6µF

Capacitance Tolerance

±5%, ±10%

Rated Voltage

250VAC

Voltage Proof

Between the terminals: 640VDC for 2 sec.

Tan δ

0.01 (max) at 1 kHz.

Insulation Resistance

(Minimum insulation resistance) R_{IS} measured at 100VDC for 1 minute.

(or) time constant $T = C_R \times R_{IS} > 2500$ s

(at 25° C, relative humidity ≤ 70%)

Life Test Conditions

1. Endurance Test

Loaded at 1.1 times of rated voltage at 70°C for 500 hours.

After the Test

$\Delta C/C: \leq 5\%$ of initial value

Increase of Tan δ: ≤ 0.004 of initial value at 1 kHz.

Insulation Resistance: 50% of the value mentioned in IR chart.

2. Switching Test

20,000 cycles of 4 step / 5 step switch type fan regulator. (Input supply: 240 VAC, Load: Fan motor.)

After the Test

$\Delta C/C: \leq 5\%$ of initial value.

Increase of Tan δ: ≤ 0.004 of initial value at 1 kHz.

Insulation Resistance: 50% of the value mentioned in IR chart.

3. Lot to Lot Test

Loaded at 380 VAC at ambient temperature for 2 hours.

After the Test

$\Delta C/C: \leq 10\%$ of initial value for series code 77/83.

$\leq 15\%$ of initial value for series code 82.

Increase of Tan δ: ≤ 0.004 of initial value at 1 kHz.

Insulation Resistance: 50% of the value mentioned in IR chart.

Ordering code and packing units: Metallized Polyester Film Capacitors Economic Type MPET-EC-Ultima Series Code 77, 83

Rated Voltage	Rated Cap. (µF)	Dimensions (mm)					Ordering Code	Packing Units Bulk
		W (max)	H (max)	L (max)	d (±0.05)	S (±1.0)		
250VAC	1.0	6.5	15.5	31.0	0.8	27.5	77/83 105 + 02 ^A	250
	1.5	9.5	16.5	27.5	0.8	22.5	77/83 155 + 02 ^A	250
	2.2	11.5	19.5	27.5	0.8	22.5	77/83 225 + 02 ^A	250
	2.4	10.0	17.0	31.0	0.8	27.5	77/83 245 + 02 ^A	250
	3.3	13.5	21.5	27.5	0.8	22.5	77/83 335 + 02 ^A	250
	4.0	12.0	21.0	31.0	0.8	27.5	77/83 405 + 02 ^A	250
	4.3	13.0	23.0	31.0	0.8	27.5	77/83 435 + 02 ^A	250
	4.6	14.0	23.0	31.0	0.8	27.5	77/83 465 + 02 ^A	250

Note: Series code 77 indicates capacitor in brown colour and series code 83 indicates orange colour.

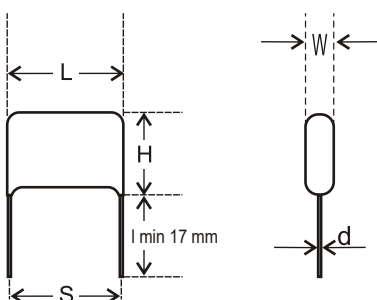

**Ordering code and packing units: Metallized Polyester Film Capacitors Economic Type
MPET-EC-Ultima Series Code 82**

Rated Voltage	Rated Cap. (μF)	Dimensions (mm)					Ordering Code	Packing Units Bulk
		W (max)	H (max)	L (max)	d (±0.05)	S (±1.0)		
250VAC	1.0	6.5	12.5	31.0	0.8	27.5	82 105 + 02 *^	250
	1.5	8.0	14.5	31.0	0.8	27.5	82 155 + 02 *^	250
	2.2	7.5	17.7	31.0	0.8	27.5	82 225 + 02 *^	250
	2.5	10.5	18.0	31.0	0.8	27.5	82 255 + 02 *^	250
	3.3	10.5	17.5	31.0	0.8	27.5	82 335 + 02 *^	250
	4.0	11.0	20.0	31.0	0.8	27.5	82 405 + 02 *^	250
	4.3	11.5	21.0	31.0	0.8	27.5	82 435 + 02 *^	250
	4.6	12.0	21.5	31.0	0.8	27.5	82 465 + 02 *^	250

Metallized Polyester Film Capacitors

Series Code
46, 98, 102

Switch Type Fan Regulator Capacitors (MPET-SW)

Main Application

Mainly used in switch type fan regulators.

Construction

Low inductive cell of metallized polyester film coated with flame retardant grade epoxy powder.

Climatic Category

40/85/21

Maximum Operating Temperature

85°C

Capacitance Value

0.76µF-5.5µF

Capacitance Tolerance

±5%, ±10%

Rated Voltage

250VAC

Voltage Proof

Between the terminals: 640VDC for 2 sec.

Tan δ

0.01 (max) at 1 kHz.

Insulation Resistance

(Minimum insulation resistance) R_{IS}

(or) time constant $T = C_R \times R_{IS}$

> 2500 s

(at 25° C, relative humidity ≤ 70%)

Life Test Conditions

1. Endurance Test

Loaded at 1.1 times of rated voltage at 70°C for 500 hours.

After the Test

$\Delta C/C$: ≤ 5% of initial value.

Increase of Tan δ: ≤ 0.004 of initial value at 1 kHz.

Insulation Resistance: 50% of the value mentioned in IR chart.

2. Switching Test

20,000 cycles of 4 step / 5 step switch type fan regulator. (Input supply: 240 VAC, Load: Fan motor.)

After the Test

$\Delta C/C$: ≤ 5% of initial value.

Increase of Tan δ: ≤ 0.004 of initial value at 1 kHz.

Insulation Resistance: 50% of the value mentioned in IR chart.

3. Lot to Lot Test

Loaded at 440 VAC at ambient temperature for 2 hours.

After the Test

$\Delta C/C$: ≤ 10% of initial value.

Increase of Tan δ: ≤ 0.004 of initial value at 1 kHz.

Insulation Resistance: 50% of the value mentioned in IR chart.

Ordering code and packing units: Metallized Polyester Film Capacitors Switch Type Fan Regulator Capacitors MPET-SW Series Code 46, 98, 102

Rated Voltage	Rated Cap. (µF)	Dimensions (mm)					Ordering Code	Packing Units Bulk
		W (max)	H (max)	L (max)	d (±0.05)	S (±1.0)		
250VAC	0.76	7.0	12.0	31	0.8	27.5	46/98/102 764 + 02 ^A	250
	1.00	6.5	15.0	31	0.8	27.5	46/98/102 105 + 02 ^A	250
	1.50	7.5	18.0	31	0.8	27.5	46/98/102 155 + 02 ^A	250
	2.20	8.0	21.5	31	0.8	27.5	46/98/102 225 + 02 ^A	250
	2.50	10.5	20.5	31	0.8	27.5	46/98/102 255 + 02 ^A	250
	3.30	10.5	20.5	31	0.8	27.5	46/98/102 335 + 02 ^A	250
	4.00	13.5	22.0	31	0.8	27.5	46/98/102 405 + 02 ^A	250
	4.30	11.5	26.0	31	0.8	27.5	46/98/102 435 + 02 ^A	250
	4.60	14.0	23.5	31	0.8	27.5	46/98/102 465 + 02 ^A	250
	5.50	15.0	25.0	31	0.8	27.5	46/98/102 555 + 02 ^A	250

Note: Series code 46 indicates capacitor in brown colour and series codes 98 and 102 indicate orange colour.

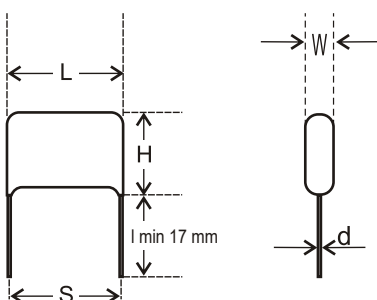

Metallized Polyester Film Capacitors

Series Code
86, 96, 103, 104, 106

Switch Type Fan Regulator Capacitors (MPET-SW-Ultima)

Main Application

Mainly used in switch type fan regulators.

Construction

Low inductive cell of metallized polyester film with internal fuses coated with flame retardant epoxy resin.

Climatic Category

40/85/21

Maximum Operating Temperature

85°C

Capacitance Value

0.75µF-5.6µF

Capacitance Tolerance

±5%, ±10%

Rated Voltage

250VAC

Voltage Proof

Between the terminals: 640VDC for 2 sec.

Tan δ

0.01 (max) at 1 kHz.

Insulation Resistance

(Minimum insulation resistance) R_{IS} measured at 100VDC for 1 minute.

(or) time constant $T = C_R \times R_{IS} > 2500$ s

(at 25° C, relative humidity ≤70%)

Life Test Conditions

1. Endurance Test

Loaded at 1.1 times of rated voltage at 70°C for 500 hours.

After the Test

$\Delta C/C$: ≤ 5% of initial value

Increase of Tan δ: ≤0.004 of initial value at 1 kHz.

Insulation Resistance: 50% of the value mentioned in IR chart.

2. Switching Test

20,000 cycles of 4 step / 5 step switch type fan regulator. (Input supply: 240 VAC, Load: Fan motor.)

After the Test

$\Delta C/C$: ≤ 5% of initial value.

Increase of Tan δ: ≤0.004 of initial value at 1 kHz.

Insulation Resistance: 50% of the value mentioned in IR chart.

3. Lot to Lot Test

Loaded at 440 VAC at ambient temperature for 2 hours.

After the Test

$\Delta C/C$: ≤ 10% of initial value.

Increase of Tan δ: ≤0.004 of initial value at 1 kHz.

Insulation Resistance: 50% of the value mentioned in IR chart.

Ordering code and packing units: Metallized Polyester Film Capacitors

Switch Type Fan Regulator Capacitors MPET-SW-Ultima Series Code 86, 96, 103, 104, 106

Rated Voltage	Rated Cap. (µF)	Dimensions (mm)					Ordering Code	Packing Units Bulk
		W (max)	H (max)	L (max)	d (±0.05)	S (±1.0)		
250VAC	0.75	7.0	13.0	31.0	0.8	27.5	86/96/103/104/106 754 + 02 *^	250
	1.00	6.5	15.0	31.0	0.8	27.5	86/96/103/104/106 105 + 02 *^	250
	1.50	8.5	17.5	31.0	0.8	27.5	86/96/103/104/106 155 + 02 *^	250
	2.20	10.5	20.5	31.0	0.8	27.5	86/96/103/104/106 225 + 02 *^	250
	2.50	11.5	17.5	31.0	0.8	27.5	86/96/103/104/106 255 + 02 *^	250
	3.30	11.5	22.5	31.0	0.8	27.5	86/96/103/104/106 335 + 02 *^	250
	4.00	13.5	22.0	31.0	0.8	27.5	86/96/103/104/106 405 + 02 *^	250
	4.30	13.0	22.5	31.0	0.8	27.5	86/96/103/104/106 435 + 02 *^	250
	4.60	14.0	23.5	31.0	0.8	27.5	86/96/103/104/106 465 + 02 *^	250
	5.60	15.0	25.0	31.0	0.8	27.5	86/96/103/104/106 565 + 02 *^	250

Note: Series code 86,103 indicates capacitor in brown colour, series code 96,104 indicates orange colour and series code 106 indicates ivory colour.

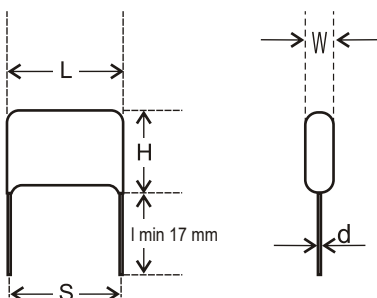

Metallized Polypropylene Film Capacitors Switch Type

Series Code
04, 64, 105

Fan Regulator Capacitors (MPP-SW)

Main Application

Mainly used in switch type fan regulators.

Construction

Low inductive cell of metallized polypropylene film, coated with flame retardant epoxy resin.

Climatic Category

40/85/21

Maximum Operating Temperature

85°C

Capacitance Value

1.0µF-5.6µF

Capacitance Tolerance

±5%, ±10%

Rated Voltage

250VAC

Voltage Proof

Between the terminals: 640VDC for 2 sec.

Tan δ

0.001 (max) at 1 kHz.

Insulation Resistance

Minimum Insulation Resistance R_{IS} 7500 s
(or) time constant $T = C_R \times R_{IS}$
(at 25° C, relative humidity ≤70%)

Life Test Conditions

1.Endurance Test

Loaded at 1.1 times of rated voltage at 70° C for 500 hours.

After The Test

$\Delta C/C$: ≤ 5% of initial value.

Increase of Tan δ: ≤0.004 of initial value at 1 kHz.

Insulation Resistance: 50% of the value mentioned in IR chart.

2.Switching Test

20,000 cycles of 4 step / 5 step switchtype fan regulator. (Input supply: 240 VAC, Load: Fan motor.)

After The Test

$\Delta C/C$: ≤ 5% of initial value.

Increase of Tan δ: ≤0.004 of initial value at 1 kHz.

Insulation Resistance: 50% of the value mentioned in IR chart.

3..Lot to Lot Test

Loaded at 540 VAC at ambient temperature for 2 hours for series code 04 and 105 and 440 VAC at ambient temperature for 2 hours for series code 64.

After The Test

$\Delta C/C$: ≤ 10% of initial value.

Increase of Tan δ: ≤0.004 of initial value at 1 kHz.

Insulation Resistance: 50% of the value mentioned in IR chart.

**Ordering code and packing units: Metallized Polypropylene Film Capacitors Switch Type
Fan Regulator Capacitors MPP-SW Series Code 04, 105**

Rated Voltage	Rated Cap. (µF)	Dimensions (mm)					S (±1.0)	Ordering Code	Packing Units Bulk
		W (max)	H (max)	L (max)	d (±0.05)				
250VAC	1.0	9.0	18.0	31.0	0.8	27.5	04/105 105 + 02 ^A	250	
	1.5	11.0	20.0	31.0	0.8	27.5	04/105 155 + 02 ^A	250	
	2.2	10.0	22.0	31.0	0.8	27.5	04/105 225 + 02 ^A	250	
	2.5	10.5	22.5	31.0	0.8	27.5	04/105 255 + 02 ^A	250	
	3.3	15.5	23.0	31.0	0.8	27.5	04/105 335 + 02 ^A	250	
	4.0	16.5	25.5	31.0	0.8	27.5	04/105 405 + 02 ^A	250	
	4.3	17.5	26.0	31.0	0.8	27.5	04/105 435 + 02 ^A	250	
	4.6	18.5	26.5	31.0	0.8	27.5	04/105 465 + 02 ^A	250	
	5.6	18.0	31.0	31.0	0.8	27.5	04/105 565 + 02 ^A	250	

Note: Series code 04 indicates capacitor in brown colour and series code 105 indicates orange colour.

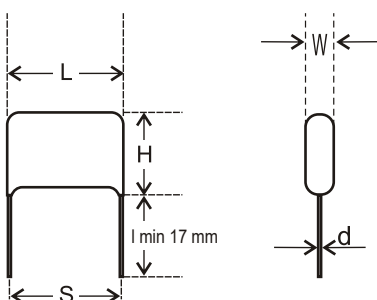

**Ordering code and packing units: Metallized Polypropylene Film Capacitors Switch Type
Fan Regulator Capacitors MPP-SW Series Code 64**

Rated Voltage	Rated Cap. (μF)	Dimensions (mm)					Ordering Code	Packing Units Bulk
		W (max)	H (max)	L (max)	d (±0.05)	S (±1.0)		
250VAC	1.0	8.5	13.5	31.0	0.8	27.5	64 105 + 02 *^	250
	1.5	9.5	15.5	31.0	0.8	27.5	64 155 + 02 *^	250
	2.2	11.0	18.0	31.0	0.8	27.5	64 225 + 02 *^	250
	2.5	10.5	22.5	31.0	0.8	27.5	64 255 + 02 *^	250
	3.3	13.0	21.0	31.0	0.8	27.5	64 335 + 02 *^	250
	4.0	14.0	23.0	31.0	0.8	27.5	64 405 + 02 *^	250
	4.3	15.0	23.5	31.0	0.8	27.5	64 435 + 02 *^	250
	4.6	16.0	24.0	31.0	0.8	27.5	64 465 + 02 *^	250
	5.6	17.0	29.0	31.0	0.8	27.5	64 565 + 02 *^	250

Metallized Polypropylene Film Capacitors

Series Code
84

Switch Type Fan Regulator Capacitors (MPP-SW-Ultima)

Main Application

Mainly used in switch type fan regulators.

Construction

Low inductive cell of metallized polypropylene film with internal fuses coated with flame retardant epoxy resin.

Climatic Category

40/85/21

Maximum Operating Temperature

85°C

Capacitance Value

1.0µF-4.6µF

Capacitance Tolerance

±5%, ±10%

Rated Voltage

250VAC

Voltage Proof

Between the terminals: 640VDC for 2 sec.

Tan δ

0.001 (max) at 1 kHz.

Insulation Resistance

(Minimum insulation resistance) R_{IS} measured at 100VDC for 1 minute.

(or) time constant $T = C_R \times R_{IS} > 7500$ s

(at 25° C, relative humidity ≤70%)

Life Test Conditions

1. Endurance Test

Loaded at 1.1 times of rated voltage at 70°C for 500 hours.

After the Test

$\Delta C/C$: ≤ 5% of initial value

Increase of Tan δ: ≤0.004 of initial value at 1 kHz.

Insulation Resistance: 50% of the value mentioned in IR chart.

2. Switching Test

20,000 cycles of 4 step / 5 step switch type fan regulator. (Input supply: 240 VAC, Load: Fan motor.)

After the Test

$\Delta C/C$: ≤ 5% of initial value.

Increase of Tan δ: ≤0.004 of initial value at 1 kHz.

Insulation Resistance: 50% of the value mentioned in IR chart.

3. Lot to Lot Test

Loaded at 440 VAC at ambient temperature for 2 hours.

After the Test

$\Delta C/C$: ≤ 10% of initial value.

Increase of Tan δ: ≤0.004 of initial value at 1 kHz.

Insulation Resistance: 50% of the value mentioned in IR chart.

**Ordering code and packing units: Metallized Polypropylene Film Capacitors
Switch Type Fan Regulator Capacitors MPP-SW-Ultima Series Code 84**

Rated Voltage	Rated Cap. (µF)	Dimensions (mm)					Ordering Code	Packing Units Bulk
		W (max)	H (max)	L (max)	d (±0.05)	S (±1.0)		
250VAC	1.0	7.5	13.5	31.0	0.8	27.5	84 105 + 02 ^A	250
	1.5	8.0	16.0	31.0	0.8	27.5	84 155 + 02 ^A	250
	2.2	10.5	17.0	31.0	0.8	27.5	84 225 + 02 ^A	250
	2.4	10.0	17.5	31.0	0.8	27.5	84 245 + 02 ^A	250
	3.3	12.0	21.0	31.0	0.8	27.5	84 335 + 02 ^A	250
	4.0	14.0	23.0	31.0	0.8	27.5	84 405 + 02 ^A	250
	4.3	13.0	21.5	31.0	0.8	27.5	84 435 + 02 ^A	250
	4.6	15.0	24.0	31.0	0.8	27.5	84 465 + 02 ^A	250

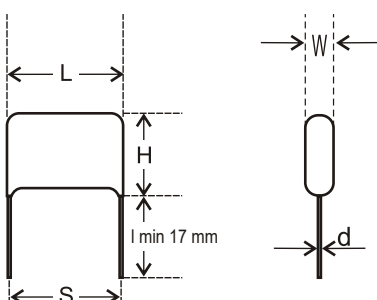

Metallized Polypropylene Film Capacitors

Series Code
44, 74, 93, 95

Fan Regulator Capacitors (MPP-Ultima)

Main Application

Mainly used in switch type fan regulators.

Construction

Low inductive cell of metallized polypropylene film with internal fuses, coated with flame retardant epoxy resin.

Climatic Category

40/85/21

Maximum Operating Temperature

85°C

Capacitance Value

1.0µF-4.6µF

Capacitance Tolerance

±5%, ±10%

Rated Voltage

250VAC

Voltage Proof

Between the terminals: 640VDC for 2 sec.

Tan δ

0.001 (max) at 1 kHz.

Insulation Resistance

(Minimum insulation resistance) R_{IS} measured at 100VDC for 1 minute.

(or) time constant $T = C_R \times R_{IS} > 7500$ s

(at 25° C, relative humidity ≤ 70%)

Life Test Conditions

1. Endurance Test

Loaded at 1.1 times of rated voltage at 70°C for 500 hours.

After the Test

$\Delta C/C$: ≤ 5% of initial value

Increase of Tan δ: ≤ 0.004 of initial value at 1 kHz.

Insulation Resistance: 50% of the value mentioned in IR chart.

2. Switching Test

20,000 cycles of 4 step / 5 step switch type fan regulator. (Input supply: 240 VAC, Load: Fan motor.)

After the Test

$\Delta C/C$: ≤ 5% of initial value.

Increase of Tan δ: ≤ 0.004 of initial value at 1 kHz.

Insulation Resistance: 50% of the value mentioned in IR chart.

3. Lot to Lot Test

Loaded at 440 VAC at ambient temperature for 2 hours. at ambient temperature for 2 hours.

After the Test

$\Delta C/C$: ≤ 10% of initial value.

Increase of Tan δ: ≤ 0.004 of initial value at 1 kHz.

Insulation Resistance: 50% of the value mentioned in IR chart.

Ordering code and packing units: Metallized Polypropylene Film Capacitors MPP-Ultima Series Code 44, 95

Rated Voltage	Rated Cap. (µF)	Dimensions (mm)					Ordering Code	Packing Units Bulk
		W (max)	H (max)	L (max)	d (±0.05)	S (±1.0)		
250VAC	1.0	8.5	16.5	31.0	0.8	27.5	44/95 105 + 02 ^A	250
	1.5	9.0	18.0	31.0	0.8	27.5	44/95 155 + 02 ^A	250
	2.2	8.5	20.0	31.0	0.8	27.5	44/95 225 + 02 ^A	250
	2.5	13.0	20.0	31.0	0.8	27.5	44/95 255 + 02 ^A	250
	3.3	11.5	20.0	31.0	0.8	27.5	44/95 335 + 02 ^A	250
	4.0	14.0	24.0	31.0	0.8	27.5	44/95 405 + 02 ^A	250
	4.3	16.0	25.0	31.0	0.8	27.5	44/95 435 + 02 ^A	250
	4.6	17.0	25.0	31.0	0.8	27.5	44/95 465 + 02 ^A	250

Note: Series code 44 indicates capacitor in brown colour and series code 95 indicates orange colour.

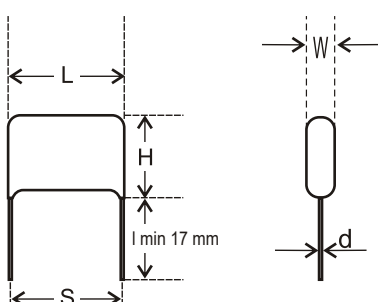

**Ordering code and packing units: Metallized Polypropylene Film Capacitors
MPP-Ultima Series Code 74, 93**

Rated Voltage	Rated Cap. (μF)	Dimensions (mm)					Ordering Code	Packing Units Bulk
		W (max)	H (max)	L (max)	d (±0.05)	S (±1.0)		
250VAC	1.0	8.5	17.5	31.0	0.8	27.5	74//93 105 + 02 *^	250
	1.5	10.5	19.5	31.0	0.8	27.5	74/93 155 + 02 *^	250
	2.2	11.5	22.0	31.0	0.8	27.5	74/93 225 + 02 *^	250
	2.5	11.5	24.5	31.0	0.8	27.5	74/93 255 + 02 *^	250
	3.3	14.5	24.0	31.0	0.8	27.5	74/93 335 + 02 *^	250
	4.0	17.0	23.5	31.0	0.8	27.5	74/93 405 + 02 *^	250
	4.3	17.5	26.0	31.0	0.8	27.5	74/93 435 + 02 *^	250
	4.6	18	27.0	31.0	0.8	27.5	74/93 465 + 02 *^	250

Note: Series code 74 indicates capacitor in brown colour and series code 93 indicates orange colour.

CDI Capacitors

Series Code
08 (MPET) 09 (MPP)

Main Application

Capacitor discharge ignition used in two-wheeler ignition systems.

Construction

Low inductive cell of metallised polyester or polypropylene film coated with flame retardant grade epoxy resin.

Climatic Category

40/85/56

Applicable Specification

IEC 384-16 for MPP and IEC 384-2 for MPET.

Capacitance Value

0.68 μ F-3.30 μ F

Rated Voltage

400VDC

Capacitance Tolerance

$\pm 10\%$

Tan δ

3.0 % (maximum) at 100 kHz (MPET)
1.5 % (maximum) at 100 kHz (MPP)

Voltage Proof

Between terminals: 1.6 times of rated voltage for 2 sec.

Insulation Resistance

Minimum Insulation Resistance
(or) time constant $T = C_R \times R_{IS} > 10000$ sec for MPET and 30000 sec for MPP at 100 V DC at 20° C, relative humidity $\leq 70\%$.

Life Test Conditions

Loaded at 1.25 times of rated voltage at 85° C or 1.25 times of category voltage at 100° C for 1000 hours.
Category voltage is 80% of rated voltage.

After the Test:

$\Delta C/C \leq 5\%$ of initial value.

Increase of Tan δ : ≤ 0.005 , $C_R > 1\mu$ F

Insulation resistance: $\geq 50\%$ of the value mentioned in IR chart.

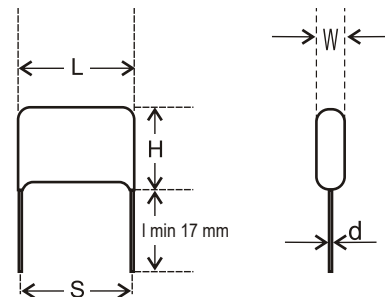

Rated Voltage	Rated Cap. (μ F)	Dimensions (mm)					Wt. g	Ordering code	Packing units Bulk
		W ± 0.5	H ± 0.5	L ± 0.5	d ± 0.05	S ± 1.0			
400 VDC	1.00	8.0	18	32	0.8	27.5	4.0	08 105 +2G*^A	500
MPET Series	1.40	8.0	18	32	0.8	27.5	5.5	08 145 +2G*^A	250
	1.50	10.0	18	32	0.8	27.5	6.10	08 155 +2G*^A	250
	2.20	11.5	18	32	0.8	27.5	10.2	08 225 +2G*^A	250
	3.30	13.0	24	32	0.8	27.5	12.5	08 335 +2G*^A	250
400 VDC									
MPP Series	0.68	12	20	32	0.8	27.5	4.5	09 684 +2G*^A	250
	1.00	8	19	31	0.8	27.5	6.0	09 105 +2G*^A	250
	1.40	14	25	32	0.8	27.5	10.0	09 145 +2G*^A	250
	1.50	10	20	31	0.8	27.5	12.5	09 155 +2G*^A	250
	2.20	16	28	32	0.8	27.5	14.0	09 225 +2G*^A	250
	3.30	17	27.5	32	0.8	27.5	-	09 335 +2G*^A	250

Metallized Polyester Film Capacitors

Series Code
37

(Automotive)

Main Application

Blocking, bypassing, filtering, timing, coupling and decoupling, interference suppression in low voltage applications, low pulse operations.

Construction

Low inductive wound cell of metallized polyester film encased in flame retardant box.

Climatic Category

40/120/56

Rated and Maximum Operating Temperature

85 and 120 °C

Applicable Specification

IEC 384-2

Capacitance Value

As per customer requirement.

Capacitance Tolerance

±5%, ±10%

Insulation Resistance

Minimum Insulation Resistance R_{IS}
(or) time constant $T=C_R \times R_{IS}$
at 25° C, relative humidity ≤ 65%

U_R
≤ 100 V DC
> 100 V DC

Rated Voltage

100VDC-250VDC

Voltage Proof

Between terminals: 1.6 times of rated voltage for 2 sec.

Tan δ

Frequency	$C_R < 0.1 \mu F$	$0.1 \mu F \leq C_R \leq 1 \mu F$	$C_R > 1 \mu F$
1 kHz	0.8%	1.0%	1.5%
10 kHz	1.5%	1.5%	-
100 kHz	3.0%	-	-

Life Test Conditions

(Loading at elevated temperature)

Loaded at 1.25 times of rated voltage at 85°C for 1000 hours.

After The Test

$\Delta C/C \leq 8\%$ of initial value.

Increase of Tan δ: ≤ 0.003 , $C_R > 1 \mu F$

Insulation Resistance: 50% of the value mentioned in IR chart.

$C_R \leq 0.33 \mu F$	$C_R > 0.33 \mu F$
3750 MΩ	1250 s
7500 MΩ	2500 s

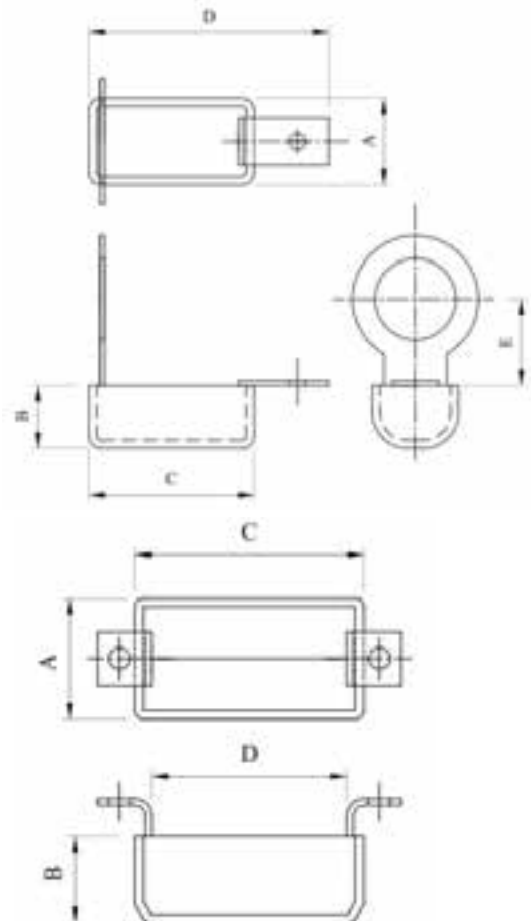
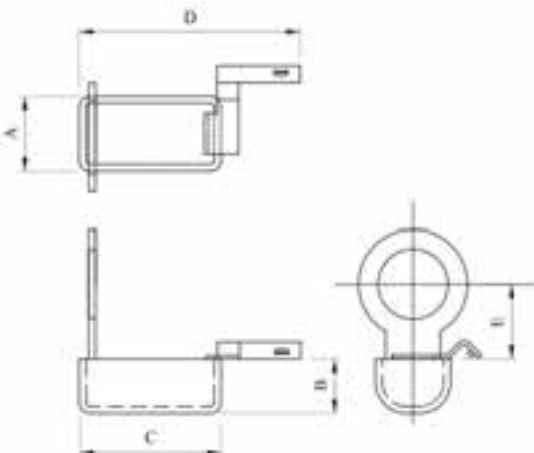
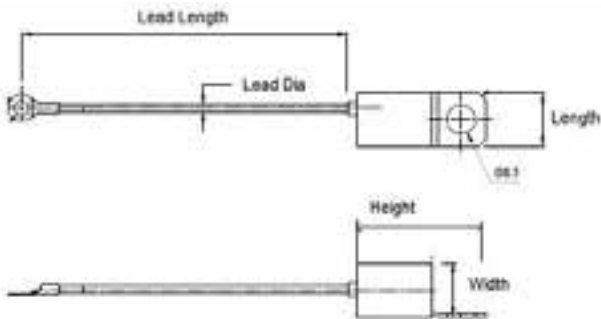

Metallized Polypropylene Motor Run Film Capacitors

Series Code
123, 137

Main Application

For general sine wave applications, mainly as motor run capacitor.

Construction

Low inductive wound cell of metallized polypropylene film encased in a flame retardant rectangular or round type box.

Climatic Category

40/85/21

Maximum Operating Temperature

85°C

Applicable Specification

IS-1709

Capacitance Value

1µF-10µF

Capacitance Tolerance

±5%, ±10%

Insulation Resistance

Minimum Insulation Resistance R_{IS} >3000s
(or) time constant $T = C_R \times R_{IS}$
Measured at 500VDC for 60 sec.
(at 25° C, relative humidity ≤65%)

Rated Voltage

440VAC

Voltage Proof

Between Terminals: 660VAC for 10 sec.

Tan δ

0.002 at 50 Hz

Endurance Test

Loaded at 1.25 times of rated voltage at 85°C for 500 hours.

After the Test

$\Delta C/C$: ≤5% of initial value
Increase of Tan δ: ≤0.005
Insulation Resistance: 50% of the value mentioned in IR chart.

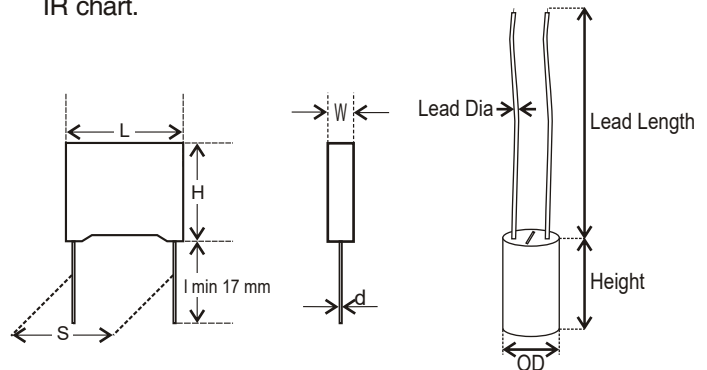

Ordering code and packing units: Metallized Polypropylene Motor Run Film Capacitors
Rectangular Box Type Series Code 123

Rated Voltage	Rated Cap. (µF)	Dimensions (mm)					Ordering Code	Packing Units Bulk
		W (±0.5)	H (±0.5)	L (±0.5)	d (±0.05)	S (±1.0)		
440VAC	1.0	13.0	22.0	32.0	0.8	27.5	123 105 + 06 ^A	150
	1.5	14.0	28.0	32.0	0.8	27.5	123 155 + 06 ^A	150
	2.0	18.0	27.5	32.0	0.8	27.5	123 205 + 06 ^A	150
	2.2	18.0	27.5	32.0	0.8	27.5	123 225 + 06 ^A	150
	2.5	22.5	32.0	32.0	0.8	27.5	123 255 + 06 ^A	150
	3.0	17.0	32.0	42.5	1.0	37.5	123 305 + 06 ^A	150
	3.5	20.0	40.0	42.5	1.0	37.5	123 355 + 06 ^A	150
	4.0	20.0	40.0	42.5	1.0	37.5	123 405 + 06 ^A	100

Ordering code and packing units: Metallized Polypropylene Motor Run Film Capacitors
Round Box Type Series Code 137

Rated Voltage	Rated Cap. (µF)	Dimensions (mm)				Ordering Code	Packing Units Bulk
		Outer Diameter (±0.5)	Height (±0.5)	Lead Length (±0.5)	Lead Dia (±0.05)		
440VAC	1.0	27	53	80	2.15	137 105 + 06 ^A	50
	1.5	27	53	80	2.15	137 155 + 06 ^A	50
	2.0	27	53	80	2.15	137 205 + 06 ^A	50
	2.2	27	53	80	2.15	137 225 + 06 ^A	50
	2.5	27	53	80	2.15	137 255 + 06 ^A	50
	3.0	35	53	80	2.15	137 305 + 06 ^A	50
	3.5	35	53	80	2.15	137 355 + 06 ^A	50
	4.0	35	53	80	2.15	137 405 + 06 ^A	50
	5.0	35	53	80	2.15	137 505 + 06 ^A	30
	6.0	35	53	80	2.15	137 605 + 06 ^A	30
	8.0	35	72	80	2.15	137 805 + 06 ^A	20
	10.0	35	72	80	2.15	137 106 + 06 ^A	20

Metallized Polypropylene DC Link Film Capacitors

Series Code
91

Main Application

As intermediate circuit capacitor on PCB, DC filtering, wind power invertors, solar power invertors, frequency convertors, high power convertors.

Construction

Low inductive cell of metallized polypropylene film enclosed in flame retardant box with UL94V-0 grade epoxy resin.

Climatic Category

40/85/56

1.25°C derating on rated voltage between 70 to 85°C

Applicable Specification

IEC 61071

Insulation Resistance

RC between leads at +25°C: ≥ 10000 sec (MΩ×μF)

Measuring voltage: 100V for 1 minute.

Capacitance Value

10μF-120μF

Rated Voltage

450VDC-1100VDC

Capacitance Tolerance

±5%, ±10%

Voltage Proof

Between terminals: 1.5 times of rated voltage for 10 sec.

Terminal to case: 3 kVAC at 50 Hz 1 minute.

Tan δ

Specified in ordering and packing table.

Ordering code and packing units: Metallized Polypropylene DC Link Film Capacitors Series Code 91

Cap (μF)	L	H	B	Dimension (mm)			tanδ×10 ⁻⁴		Ir max (A)	Ip-k (A)	Is (A)	ESR (mΩ)	Ordering Code
				P1	P2	D	1kHz	10kHz					
Un 450VDC		Us 675V		Ur 100V	UBB 675V		UBG 3000VAC						
10	32.0	25	14	27.5	-	0.8	10	100	6.5	650	1950	7.5	91 106 + 2I ^A
20	32.0	37	22	27.5	-	0.8	10	100	6.0	1300	3900	6.5	91 206 + 2I ^A
30	43.0	40	20	37.5	12.5	1.2	15	150	13.0	376	1128	3.5	91 306 + 2I ^A
40	43.0	35	33	37.5	20.3	1.2	15	150	14.0	501	1504	2.7	91 406 + 2I ^A
45	43.0	35	33	37.5	20.3	1.2	15	150	14.0	564	1692	2.7	91 456 + 2I ^A
50	42.5	45	30	37.5	20.3	1.2	15	150	19.0	437	1310	3.7	91 506 + 2I ^A
55	42.5	45	30	37.5	20.3	1.2	15	150	20.0	480	1441	3.5	91 556 + 2I ^A
60	42.5	45	30	37.5	20.3	1.2	15	150	20.0	524	1572	3.3	91 606 + 2I ^A
65	57.5	45	30	52.5	20.3	1.2	35	350	20.0	568	1703	3.3	91 656 + 2I ^A
70	57.5	45	30	52.5	20.3	1.2	35	350	20.0	611	1834	3.3	91 706 + 2I ^A
75	57.5	45	30	52.5	20.3	1.2	35	350	20.0	655	1965	3.3	91 756 + 2I ^A
80	57.5	45	30	52.5	20.3	1.2	35	350	20.0	699	2096	3.3	91 806 + 2I ^A
85	57.5	45	30	52.5	20.3	1.2	35	350	20.0	743	2228	3.3	91 856 + 2I ^A
90	57.5	50	35	52.5	20.3	1.2	35	350	21.0	786	2359	3.3	91 906 + 2I ^A
95	57.5	50	35	52.5	20.3	1.2	35	350	21.0	830	2490	3.3	91 956 + 2I ^A
100	57.5	50	35	52.5	20.3	1.2	35	350	21.0	874	2621	3.2	91 107 + 2I ^A
120	57.5	60	35	52.5	20.3	1.2	35	350	25.0	1048	3145	2.5	91 127 + 2I ^A
Un 575VDC		Us 863V		Ur 100V	UBB 863V		UBG 3000VAC						
40	43.0	46	34	37.5	20.3	1.2	20	175	15.0	604	1811	3.7	91 406 + 2Q ^A
50	43.0	46	34	37.5	20.3	1.2	20	175	16.0	521	1563	5.1	91 506 + 2Q ^A
60	57.5	45	30	52.5	20.3	1.2	36	350	18.0	625	1875	4.3	91 606 + 2Q ^A
70	57.5	50	35	52.5	20.3	1.2	36	350	20.0	729	2188	3.5	91 706 + 2Q ^A
80	57.5	50	35	52.5	20.3	1.2	36	350	21.0	833	2500	3.3	91 806 + 2Q ^A
90	57.5	60	35	52.5	20.3	1.2	36	350	26.0	938	2813	2.3	91 906 + 2Q ^A
100	57.5	60	35	52.5	20.3	1.2	36	350	29.0	1042	3125	1.8	91 107 + 2Q ^A

Ordering code and packing units: Metallized Polypropylene DC Link Film Capacitors Series Code 91

Cap (μ F)	Dimension (mm)			$\tan\delta \times 10^{-4}$		Ir max (A)	Ip-k (A)	Is (A)	ESR (m Ω)	Ordering Code			
	L	H	B	P1	P2						1kHz	10kHz	
Un 800VDC		Us 1275V		Ur 200V	UBB 1275V		UBG 3000VAC						
10	43	27.5	24.5	37.5	10.2	1.2	18	160	6	172	517	8.5	91 106 + 2L ^A
20	43	37	28	37.5	20.3	1.2	18	160	11	345	1035	4.4	91 206 + 2L ^A
30	57.5	45	30	52.5	20.3	1.2	33	320	12	357	1071	8.2	91 306 + 2L ^A
40	57.5	45	30	52.5	20.3	1.2	33	320	16	476	1429	4.9	91 406 + 2L ^A
50	57.5	50	35	52.5	20.3	1.2	33	320	17	595	1786	4.9	91 506 + 2L ^A
60	57.5	60	35	52.5	20.3	1.2	33	320	17	714	2143	4.9	91 606 + 2L ^A
70	57.5	60	35	52.5	20.3	1.2	33	320	18	833	2500	4.5	91 706 + 2L ^A
100	57.7	60	45	52.5	20.3	1.2	33	320	31.4	1500	4500	4.8	91 107 + 2L ^A
Un 1000VDC		Us 1500V		Ur 200V	UBB 1500V		UBG 3000VAC						
10	43	35	34	37.5	20.3	1.2	15	140	15	140	647	7.2	91 106 + 3A ^A
20	43	46	34	37.5	20.3	1.2	15	140	15	140	1293	6.1	91 206 + 3A ^A
30	57.5	45	30	52.5	20.3	1.2	28	280	28	280	1339	5.4	91 306 + 3A ^A
40	57.5	50	35	52.5	20.3	1.2	28	280	28	280	1786	5.4	91 406 + 3A ^A
50	57.5	60	35	52.5	20.3	1.2	28	280	28	280	2232	5.0	91 506 + 3A ^A
Un 1100VDC		Us 1650V		Ur 200V	UBB 1650V		UBG 3000VAC						
8	42	40	20	37.5	10.2	1.2	15	130	15	130	621	8.0	91 805 + 2O ^A
10	43	35	34	37.5	10.2	1.2	15	130	15	130	776	6.0	91 106 + 2O ^A
12	43	35	34	37.5	10.2	1.2	15	130	15	130	931	5.4	91 126 + 2O ^A
20	57.5	45	30	52.5	20.3	1.2	27	260	27	260	1071	5.3	91 206 + 2O ^A
25	57.5	50	35	52.5	20.3	1.2	27	260	27	260	1339	4.3	91 256 + 2O ^A
30	57.5	60	35	52.5	20.3	1.2	27	260	27	260	1607	4.0	91 306 + 2O ^A

Un: Rated DC voltage • Us: Non-periodic impulse voltage • Ur: Ripple voltage • UBB: Test voltage between terminals • UBG: Pressure resistance between case and terminal

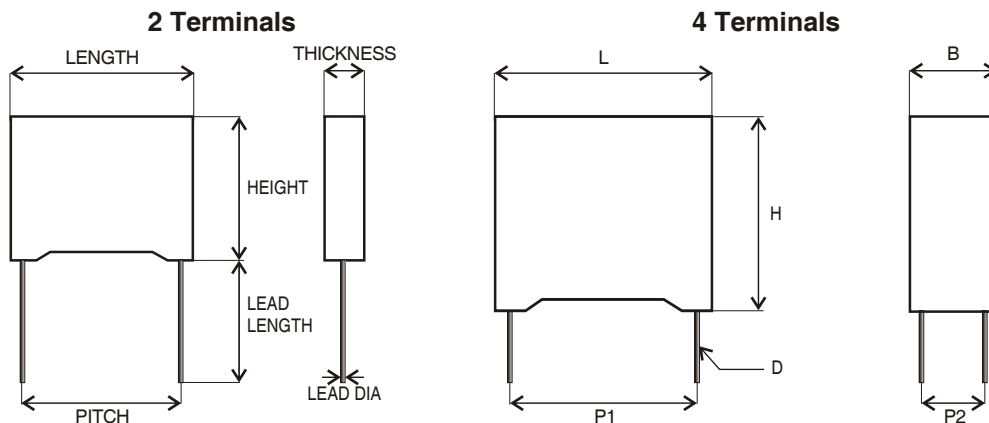

Metallized Polypropylene IGBT Snubber Capacitors

Series Code
121

Main Application

IGBT snubber capacitors are used in high voltage, high current and high pulse applications such as IGBT protection circuits, snubber network protection circuits in SMPS energy conversion and control in power electronics.

Construction

Double metallized film and MPP film internal series encased in flame retardant box.

Climatic Category

40/85/56

Maximum Operating Temperature

85°C

Applicable Specification

IEC 61071

Capacitance Value

0.047µF-5.6µF

Insulation Resistance

Minimum Insulation Resistance R_{is} 30000 s
(or) time constant $T=C_R \times R_{is}$

Capacitance Tolerance

±5%, ±10%

Rated Voltage

700VDC-3000VDC

Voltage Proof

Between terminals: 2 times of the rated voltage for 10 sec.

Tan δ

0.06% (maximum) at 1 kHz.

Life Test Conditions

(Loading at elevated temperature)

Loaded at 1.25 times of rated voltage at 85°C for 1000 hours.

After the Test

$\Delta C/C$: ≤ 3% of initial value.

Increase of Tan δ: ≤ 1.4 times the value measured before the test.

Insulation Resistance: 50% of the value mentioned in IR chart.

Style →	Style B				Style U				Style E
Length (mm)	P2	P1	P2	P1	P2	P1	P2	P1	P1
43.0	11	23-28	8	20-25	11	23-28	8	20-25	51-64
57.5	11	23-28	24	37-42	11	23-28	24	37-42	66-79

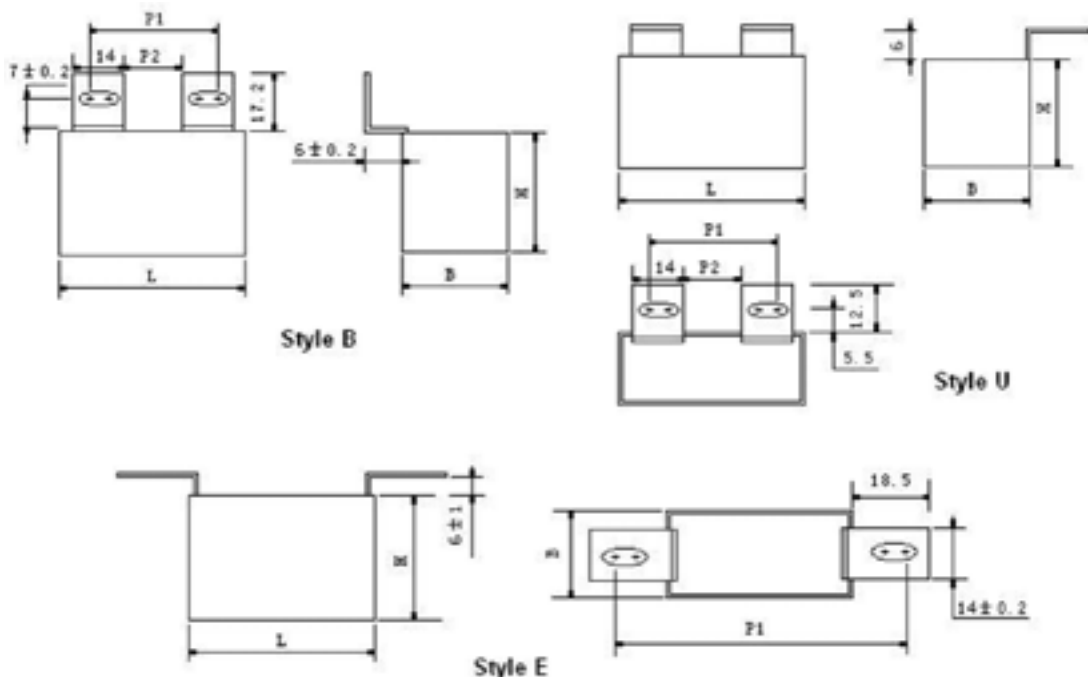

**Ordering code and packing units: Metallized Polypropylene IGBT Snubber Capacitors
Series Code 121**

Rated Cap. (μ F)	Dimensions (mm)			dv/dt (V/ μ s)	Ipeak (A)	Irms (max) (A)	ESR (m Ω)	Ordering Code
	W (\pm 0.5)	H (\pm 0.5)	L (\pm 0.5)					
Ur 700VDC, Urms 380VAC, Upk 1000VDC								
1.20	24.5	27.5	43.0	325	390	16.5	3.1	121 125 +2K *^
2.00	33.5	36.0	43.0	325	650	22.0	2.5	121 205 +2K *^
2.20	33.5	36.0	43.0	325	715	22.5	2.4	121 225 +2K *^
2.50	33.5	36.0	43.0	325	812	23.0	2.2	121 255 +2K *^
3.00	34.0	46.0	43.0	325	975	26.0	2.1	121 305 +2K *^
3.30	34.0	46.0	43.0	325	1072	26.0	2.1	121 335 +2K *^
3.50	34.0	46.0	43.0	325	1140	27.0	2.0	121 355 +2K *^
4.00	30.0	46.0	57.5	220	880	27.0	2.3	121 405 +2K *^
4.70	35.0	50.0	57.5	220	1034	31.0	2.1	121 475 +2K *^
5.00	35.0	50.0	57.5	220	1100	31.0	2.1	121 505 +2K *^
5.60	35.0	50.0	57.5	220	1232	32.0	2.0	121 565 +2K *^
Ur 850VDC, Urms 450VAC, Upk 1200VDC								
0.82	24.5	27.5	43.0	400	328	15.5	3.1	121 824 +2M *^
1.00	24.5	27.5	43.0	400	400	17.5	2.7	121 105 +2M *^
1.50	33.5	36.0	43.0	400	600	23.0	2.2	121 155 +2M *^
2.00	33.5	36.0	43.0	400	700	23.5	2.2	121 205 +2M *^
2.20	33.5	36.0	43.0	400	800	26.5	2.0	121 225 +2M *^
2.50	34.0	46.0	43.0	400	880	27.0	2.0	121 255 +2M *^
3.00	30.0	46.0	57.5	400	1000	28.0	1.9	121 305 +2M *^
3.30	30.0	46.0	57.5	280	840	28.5	2.2	121 335 +2M *^
4.00	35.0	50.0	57.5	280	924	29.5	2.1	121 405 +2M *^
4.70	35.0	50.0	57.5	280	1120	32.0	1.9	121 475 +2M *^
Ur 1000VDC, Urms 480VAC, Upk 1400VDC								
0.68	24.5	27.5	43.0	500	340	15.0	3.3	121 684 +3A *^
0.75	24.5	27.5	43.0	500	375	15.5	3.2	121 754 +3A *^
1.20	33.5	36.0	43.0	500	600	22.0	2.5	121 125 +3A *^
1.50	33.5	36.0	43.0	500	750	23.5	2.2	121 155 +3A *^
1.70	34.0	46.0	43.0	500	875	25.5	2.1	121 175 +3A *^
2.00	34.0	46.0	43.0	500	1000	26.5	2.0	121 205 +3A *^
2.20	30.0	46.0	57.5	350	770	26.5	2.5	121 225 +3A *^
3.00	35.0	50.0	57.5	350	1050	31.0	2.1	121 305 +3A *^
3.30	35.0	50.0	57.5	350	1155	31.0	2.0	121 335 +3A *^
Ur 1200VDC, Urms 500VAC, Upk 1600VDC								
0.33	24.5	27.5	43.0	650	210	12.0	5.1	121 334 +2P *^
0.39	24.5	27.5	43.0	650	254	13.0	4.6	121 394 +2P *^
0.47	24.5	27.5	43.0	650	308	14.0	4.1	121 474 +2P *^
0.56	24.5	27.5	43.0	650	365	14.5	3.7	121 564 +2P *^
0.68	33.5	36.0	43.0	650	442	19.0	3.3	121 684 +2P *^
0.82	33.5	36.0	43.0	650	533	20.0	3.0	121 824 +2P *^
1.00	33.5	36.0	43.0	650	650	20.5	2.7	121 105 +2P *^
1.20	34.0	46.0	43.0	650	780	23.5	2.4	121 125 +2P *^
1.50	34.0	46.0	43.0	650	975	25.0	2.1	121 155 +2P *^
2.00	30.0	46.0	57.5	455	910	27.0	2.4	121 205 +2P *^
2.20	35.0	50.0	57.5	455	1000	30.0	2.4	121 225 +2P *^
2.50	35.0	50.0	57.5	455	1138	31.0	2.3	121 255 +2P *^
3.00	35.0	50.0	57.5	455	1365	32.0	2.1	121 305 +2P *^

**Ordering code and packing units: Metallized Polypropylene IGBT Snubber Capacitors
Series Code 121 (continued)**

Rated Cap. (µF)	Dimensions (mm)			dv/dt (V/µs)	Ipeak (A)	Irms (max) (A)	ESR (mΩ)	Ordering Code
	W (±0.5)	H (±0.5)	L (±0.5)					
Ur 1500VDC, Urms 575VAC, Upk 2000VDC								
0.33	24.5	27.5	43.0	800	264	13.5	4.6	121 334 +3R *^
0.39	24.5	27.5	43.0	800	312	14.0	4.3	121 394 +3R *^
0.47	33.5	36.0	43.0	800	376	18.0	3.7	121 474 +3R *^
0.68	33.5	36.0	43.0	800	544	19.5	3.1	121 684 +3R *^
0.75	33.5	36.0	43.0	800	600	20.5	2.8	121 754 +3R *^
1.00	34.0	46.0	43.0	800	800	23.0	2.5	121 105 +3R *^
1.20	30.0	46.0	57.5	560	672	25.0	2.8	121 125 +3R *^
1.50	35.0	50.0	57.5	560	840	28.0	2.5	121 155 +3R *^
1.80	35.0	50.0	57.5	560	1008	29.5	2.3	121 185 +3R *^
Ur 1700VDC, Urms 575VAC, Upk 2000VDC								
0.22	24.5	27.5	43.0	880	194	13.2	5.3	121 224 +3S *^
0.33	24.5	27.5	43.0	880	290	14.0	5.0	121 334 +3S *^
0.47	33.5	36.0	43.0	880	414	19.0	3.8	121 474 +3S *^
0.56	33.5	36.0	43.0	880	493	19.5	3.1	121 564 +3S *^
0.68	33.5	36.0	43.0	880	598	20.0	2.9	121 684 +3S *^
0.82	34.0	46.0	43.0	880	722	22.1	2.5	121 824 +3S *^
1.00	30.0	46.0	57.5	610	610	23.5	2.7	121 105 +3S *^
1.20	30.0	46.0	57.5	610	732	26.2	2.6	121 125 +3S *^
1.50	35.0	50.0	57.5	610	915	28.5	2.4	121 155 +3S *^
Ur 2000VDC, Urms 630VAC, Upk 2400VDC								
0.10	24.5	27.5	43.0	1000	100	8.0	13.0	121 104 +3D *^
0.15	24.5	27.5	43.0	1000	150	10.5	7.5	121 154 +3D *^
0.22	24.5	27.5	43.0	1000	220	12.0	5.1	121 224 +3D *^
0.33	33.5	36.0	43.0	1000	330	16.5	4.1	121 334 +3D *^
0.39	33.5	36.0	43.0	1000	390	17.5	3.6	121 394 +3D *^
0.47	34.0	46.0	43.0	1000	470	20.5	3.2	121 474 +3D *^
0.56	34.0	46.0	43.0	1000	560	21.5	3.0	121 564 +3D *^
0.68	30.0	46.0	57.5	700	476	22.5	3.5	121 684 +3D *^
0.82	30.0	46.0	57.5	700	574	24.0	3.1	121 824 +3D *^
1.00	35.0	50.0	57.5	700	700	27.0	2.8	121 105 +3D *^
1.20	35.0	50.0	57.5	700	840	29.0	2.4	121 125 +3D *^
Ur 2500VDC, Urms 700VAC, Upk 3000VDC								
0.10	24.5	27.5	43.0	1350	135	9.0	11.2	121 104 +3E *^
0.15	24.5	27.5	43.0	1350	202	11.0	7.2	121 154 +3E *^
0.22	33.5	36.0	43.0	1350	297	15.0	5.2	121 224 +3E *^
0.33	33.5	36.0	43.0	1350	445	18.0	3.8	121 334 +3E *^
0.47	34.0	46.0	43.0	1350	634	22.0	3.0	121 474 +3E *^
0.56	30.0	46.0	57.5	945	529	22.5	3.5	121 564 +3E *^
0.68	35.0	50.0	57.5	945	634	25.0	3.2	121 684 +3E *^
0.82	35.0	50.0	57.5	945	775	26.0	2.9	121 824 +3E *^
Ur 3000VDC, Urms 750VAC, Upk 3500VDC								
0.047	24.5	27.5	43.0	1600	75	7.4	17.0	121 473 +3F *^
0.068	24.5	27.5	43.0	1600	109	9.0	12.0	121 683 +3F *^
0.100	33.5	36.0	43.0	1600	160	12.0	8.5	121 105 +3F *^
0.150	33.5	36.0	43.0	1600	240	14.5	6.1	121 154 +3F *^
0.220	34.0	46.0	43.0	1600	352	17.6	4.3	121 224 +3F *^
0.330	30.0	46.0	57.5	870	287	21.0	4.2	121 334 +3F *^
0.470	35.0	50.0	57.5	870	409	23.0	3.9	121 473 +3F *^

Metallized Polypropylene IGBT Snubber Capacitors

Series Code
150

Main Application

IGBT snubber capacitors are used in high voltage, high current and high pulse applications such as IGBT protection circuits, snubber network protection circuits in SMPS energy conversion and control in power electronics.

Construction

Series constructed, low inductive wound cell of metallized polypropylene film as electrodes encased in flame retardant box.

Climatic Category

40/85/56

Maximum Operating Temperature

85°C

Applicable Specification

IEC 61071

Capacitance Value

1.5µF-10µF

Insulation Resistance

Minimum Insulation Resistance R_{is} 30000 s
(or) time constant $T=C_R \times R_{is}$

Capacitance Tolerance

±5%, ±10%

Rated Voltage

700VDC-3000VDC

Voltage Proof

Between terminals: 2 times of the rated voltage for 10 sec.

Tan δ

0.06% (maximum) at 1 kHz.

Life Test Conditions

(Loading at elevated temperature)

Loaded at 1.25 times of rated voltage at 85° C for 1000 hours.

After the Test

$\Delta C/C$: ≤ 3% of initial value.

Increase of Tan δ: ≤ 1.4 times the value measured before the test.

Insulation Resistance: 50% of the value mentioned in IR chart.

Style→	Style B				Style U				Style E
Length (mm)	P2	P1	P2	P1	P2	P1	P2	P1	P1
43.0	11	23-28	8	20-25	11	23-28	8	20-25	51-64
57.5	11	23-28	24	37-42	11	23-28	24	37-42	66-79

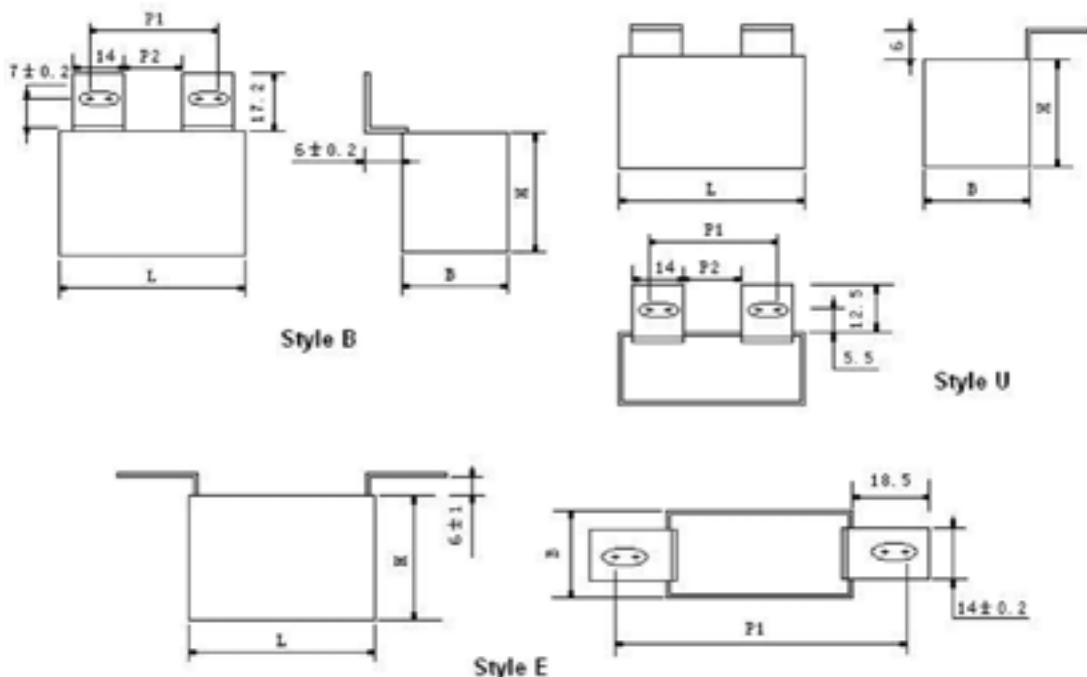

**Ordering code and packing units: Metallized Polypropylene IGBT Snubber Capacitors
Series Code 150**

Rated Cap. (μ F)	Dimensions (mm)			dv/dt (V/ μ s)	Ipeak (A)	Irms (max) (A)	ESR (m Ω)	Ordering Code
	W (\pm 0.5)	H (\pm 0.5)	L (\pm 0.5)					
Ur 700VDC, Urms 380VAC, Upk 1000VDC								
1.5	24.5	27.5	43.0	132	198	15	3.6	150 155 +2K *^
2.0	33.5	36.0	43.0	132	264	16	3.1	150 205 +2K *^
3.0	33.5	36.0	43.0	132	396	20	2.6	150 305 +2K *^
3.3	33.5	36.0	43.0	132	436	21	2.5	150 335 +2K *^
4.0	33.5	36.0	43.0	132	528	23	2.2	150 405 +2K *^
4.7	34.0	46.0	43.0	132	620	26	1.9	150 475 +2K *^
5.0	34.0	46.0	43.0	132	660	26	1.9	150 505 +2K *^
5.6	34.0	46.0	43.0	132	739	27	1.8	150 565 +2K *^
6.8	30.0	50.0	57.5	90	612	27	2.3	150 685 +2K *^
8.2	35.0	50.0	57.5	90	738	32	2.1	150 825 +2K *^
10.0	35.0	50.0	57.5	90	900	32	1.9	150 106 +2K *^
Ur 850VDC, Urms 450VAC, Upk 1200VDC								
1.2	24.5	27.5	43.0	200	240	15	3.3	150 125 +2M *^
2.2	24.5	27.5	43.0	200	440	23	2.3	150 225 +2M *^
2.5	33.5	36.0	43.0	200	500	24	2.1	150 255 +2M *^
2.7	33.5	36.0	43.0	200	540	24	2.0	150 275 +2M *^
3.0	33.5	36.0	43.0	200	600	26	1.9	150 305 +2M *^
3.3	34.0	46.0	43.0	200	660	27	1.8	150 335 +2M *^
4.0	34.0	46.0	43.0	200	800	28	1.7	150 405 +2M *^
4.7	30.0	46.0	57.5	110	517	27	2.2	150 475 +2M *^
5.0	30.0	46.0	57.5	110	550	28	2.2	150 505 +2M *^
5.6	35.0	50.0	57.5	110	616	32	1.9	150 565 +2M *^
6.8	35.0	50.0	57.5	110	748	32	1.8	150 685 +2M *^
Ur 1000VDC, Urms 480VAC, Upk 1400VDC								
1.0	24.5	27.5	43.0	225	225	15	3.3	150 105 +3A *^
2.0	33.5	36.0	43.0	225	450	23	2.1	150 205 +3A *^
2.5	34.0	46.0	43.0	225	563	27	1.8	150 255 +3A *^
3.3	30.0	46.0	57.5	130	429	26	2.4	150 335 +3A *^
4.7	35.0	50.0	57.5	130	611	32	1.9	150 475 +3A *^
Ur 1200VDC, Urms 500VAC, Upk 1600VDC								
0.68	24.5	27.5	43.0	225	153	13	4.1	150 684 +2P *^
1.5	33.5	36.0	43.0	225	338	21	2.6	150 155 +2P *^
2.0	34.0	46.0	43.0	225	450	26	2.0	150 205 +2P *^
2.2	34.0	46.0	43.0	225	195	27	1.9	150 225 +2P *^
2.5	30.0	46.0	57.5	150	375	26	2.4	150 255 +2P *^
3.0	35.0	50.0	57.5	150	450	30	2.1	150 305 +2P *^
3.3	35.0	50.0	57.5	150	495	31	2.0	150 335 +2P *^
Ur 1500VDC, Urms 575VAC, Upk 2000VDC								
0.33	24.5	27.5	43.0	225	74	12	5.6	150 334 +3R *^
0.47	24.5	27.5	43.0	225	106	13	4.5	150 474 +3R *^
0.68	33.5	36.0	43.0	225	153	18	3.8	150 684 +3R *^
1.0	33.5	36.0	43.0	225	225	21	2.6	150 105 +3R *^
1.2	34.0	46.0	43.0	225	180	25	2.1	150 125 +3R *^
1.5	30.0	46.0	57.0	150	225	23	3.1	150 155 +3R *^
2.0	35.0	50.0	57.5	150	300	27	2.6	150 205 +3R *^
2.2	35.0	50.0	57.5	150	385	28	2.5	150 225 +3R *^

**Ordering code and packing units: Metallized Polypropylene IGBT Snubber Capacitors
 Series Code 150 (continued)**

Rated Cap. (μ F)	Dimensions (mm)			dv/dt (V/ μ s)	I _{peak} (A)	I _{rms} (max) (A)	ESR (m Ω)	Ordering Code
	W (\pm 0.5)	H (\pm 0.5)	L (\pm 0.5)					
Ur 2000VDC, Urms 630ac, Upk 2400VDC								
0.22	24.5	27.5	43.0	410	90	11	6.4	150 224 +3D *^
0.33	24.5	27.5	43.0	410	135	12	57	150 334 +3D *^
0.47	33.5	36.0	43.0	410	193	17	3.8	150 474 +3D *^
0.56	33.5	36.0	43.0	410	230	18	3.4	150 564 +3D *^
0.68	34.0	46.0	43.0	410	279	22	3.0	150 684 +3D *^
0.82	34.0	46.0	43.0	410	336	22	2.7	150 824 +3D *^
1.00	30.0	46.0	57.5	225	225	22	3.5	150 105 +3D *^
1.50	35.0	50.0	57.5	225	338	26	2.8	150 155 +3D *^
Ur 2500VDC, Urms 700VAC, Upk 3000VDC								
0.12	24.5	27.5	43.0	550	66	8	10.3	150 124 +3E *^
0.15	24.5	27.5	43.0	550	83	10	8.5	150 154 +3E *^
0.18	24.5	27.5	43.0	550	99	11	7.3	150 184 +3E *^
0.22	33.5	36.0	43.0	550	121	14	6.1	150 224 +3E *^
0.33	33.5	36.0	43.0	550	182	16	4.5	150 334 +3E *^
0.39	33.5	36.0	43.0	550	215	17	4.0	150 394 +3E *^
0.47	34.0	46.0	43.0	550	259	20	3.5	150 474 +3E *^
0.56	34.0	46.0	43.0	550	308	21	3.1	150 564 +3E *^
0.68	30.0	46.0	57.5	290	197	21	3.9	150 684 +3E *^
1.0	35.0	50.0	57.5	290	290	25	3.1	150 105 +3E *^
Ur 3000VDC, Urms 750VAC, Upk 3500VDC								
0.068	24.5	27.5	43.0	750	51	7	14.8	150 683 +3F *^
0.1	24.5	27.5	43.0	750	75	8	10.2	150 104 +3F *^
0.12	33.5	36.0	43.0	750	90	11	8.9	150 124 +3F *^
0.15	33.5	36.0	43.0	750	113	13	7.3	150 154 +3F *^
0.18	33.5	36.0	43.0	750	135	14	6.3	150 184 +3F *^
0.22	34.0	46.0	43.0	750	165	16	5.3	150 224 +3F *^
0.33	34.0	46.0	43.0	750	248	19	4.2	150 334 +3F *^
0.39	30.0	46.0	57.5	370	144	19	5.2	150 394 +3F *^
0.47	35.0	50.0	57.5	370	174	21	4.6	150 474 +3F *^
0.56	35.0	50.0	57.5	370	207	22	4.1	150 564 +3F *^

AQL AND INSPECTION LEVEL

1. Inspection level and AQLs are selected from ISO-2859 / IS-2500 or IEC-410. Sampling plan is single sampling for normal inspection.
 2. Symbols used: IL = inspection level (ISO-2859 / IS-2500 / IEC-410)
 AQL = acceptable quality level

NO	ITEM		PERFORMANCE REQUIREMENTS	TEST METHOD	I.L.	A.Q.L.
1	VISUAL INSPECTION					
	Marking	Rated capacitance Rated voltage Tolerance Trade mark	Marking should be legible	Visual inspection	General inspection level II	1.0 %
	Mechanical Failure	Lead wire broken Insufficient coating	There shall be no mechanical failure	-do-		
2	DIMENSION	Should confirm to the specification chart	As specified in the data sheet	Gauging	Special inspection level S-1	2.5%
3	ELECTRICAL PROPERTIES					
	Voltage Proof	Between termination As per relevant specification	No break down or flash over of application:	Test voltage and duration of level I	General inspection	0.1%
	Capacitance	Within specified tolerance Tangent of loss angle specifications	Measuring frequency according to IEC spec. As per Measuring frequency relevant according to IEC spec.			
	Insulation Resistance	As per relevant specifications	As per test method in the specifications			
4	SOLDERABILITY		Good shine, free flowing of solder with wetting of the terminations	Without aging Dip test as per IS - 9000 Non-activated Colophony Flux		2.5%

PACKING STANDARDS

Bulk packing

Capacitors, packed in 4 inner polybags, are sealed in identified outer polybags and despatched in cartons.

Each box/inner polybag bears an identification slip carrying the lot number. This lot number should be referred to in all feedback/ correspondence.

Note: For CDI, Film Foil Non-Inductive capacitors, and other capacitors not included here, please ask for packing standard.

Enquiry information

When making an enquiry, please specify:

1. Working voltage
2. Capacitance value and tolerance
3. Finished product: Colour TV, audio, industrial equipment, electronic ballast, etc
4. Application or circuit diagram, noise suppression, resonance, etc.
5. Condition of operation: Pulse, frequencies, waveform, current
6. Operating temperature
7. Dimensions and type of capacitor
8. Safety: Influence on other components when the capacitor gets short-circuited or opened. Influence on the capacitor when other components or the circuit works irregularly.
9. Current source and specification reference
10. Approximate monthly requirement
11. Any other relevant information

Cautions

1. Change of capacitance value in the course of time.

The capacitor changes in its characteristics depending on ambient temperature and environmental conditions. Details on the permissible / expected change w.r.t. time can be requested from the Technical Cell.

2. Hum (Buzz). Hum produced by capacitors may be due to mechanical vibration of the film caused by the Coulomb force existing between electrodes of opposite polarity. A louder hum is produced when applied voltage waveform has distortion or has a higher frequency component. Hum, though, does not spoil the characteristics of the capacitor.

Handling cautions

Sudden charging or discharging may cause deterioration of the capacitor such as shorting and opening due to charging or discharging current. When charging or discharging pass through a resistance of 20 to 1000 W / V or more. Be careful not to apply excessive force to the lead wire root area which may cause crack or clearance in the coating resin near the root area.

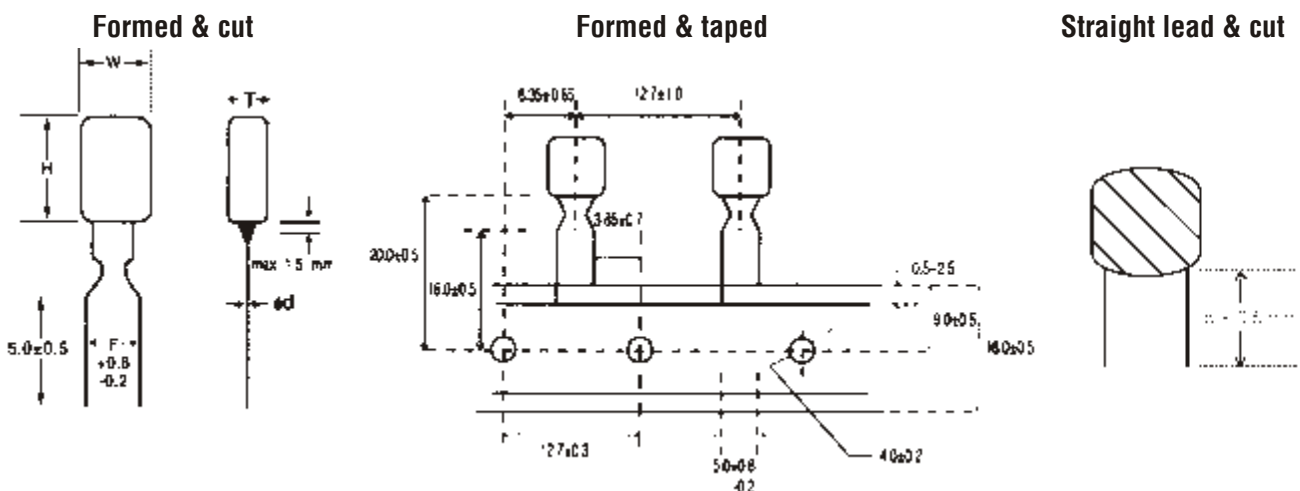
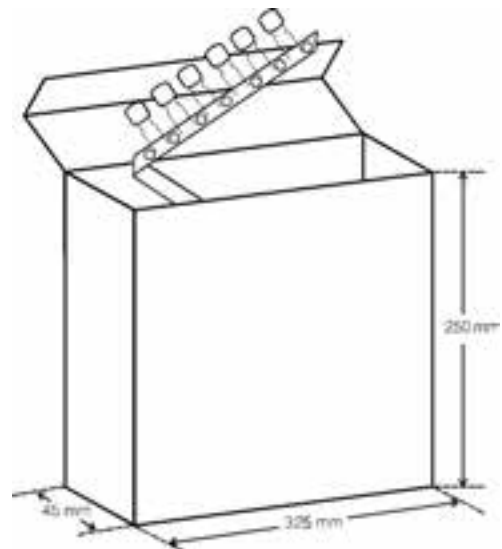

PACKING STYLES

Ammo Packing: 5 mm Pitch

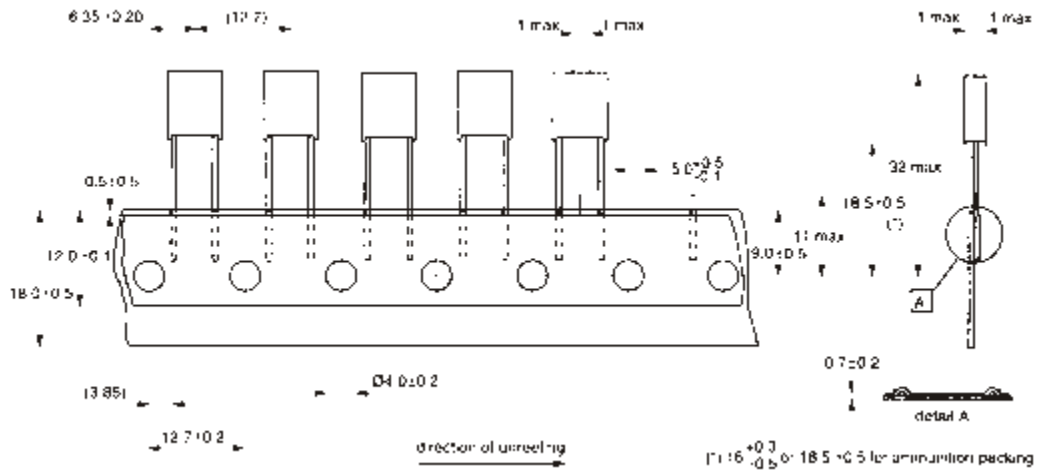

Ammo Packing: 7.5 mm Pitch

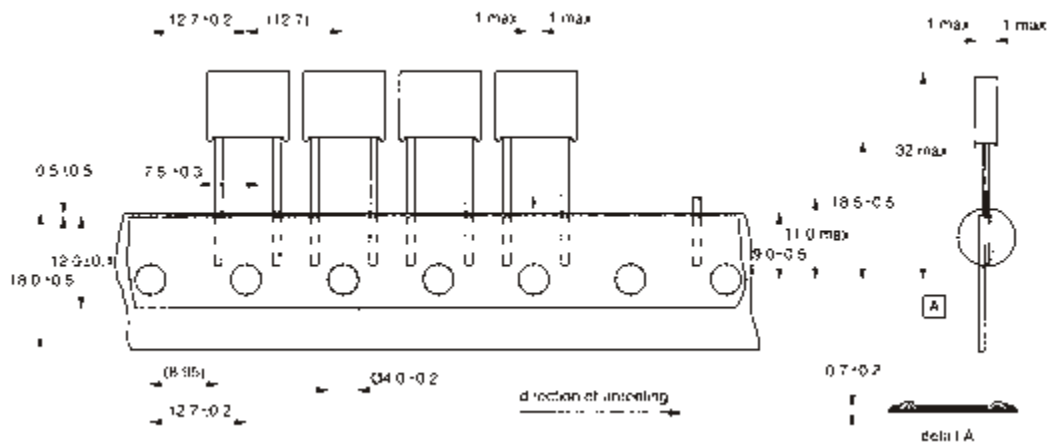

Reel Packing

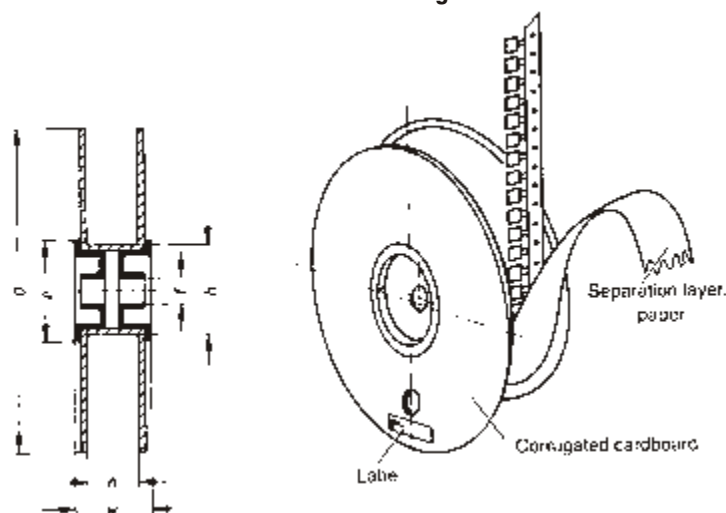

Dimensions (mm)	n	w	d	e	f	h
Lead spacing ≤ 7.5	42+1	52 max	dia 360-1	dia 90	dia 30.5 ± 0.2	dia 82+1
Lead spacing ≥ 10	54+1	70 max	dia 500-1	dia 130	dia 30.5 ± 0.2	dia 126+1

PACKING STYLES

Ammo Packing: 7.5-5.0 mm Pitch

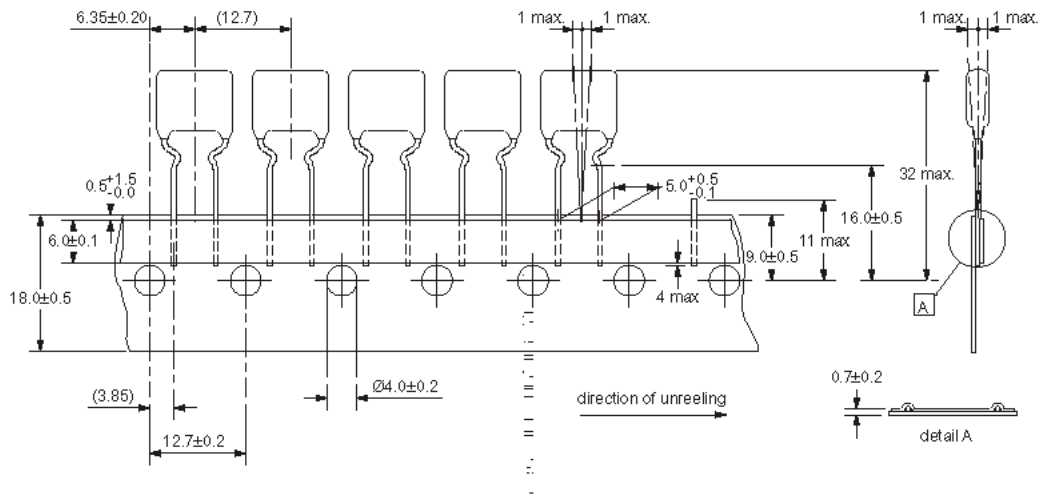

Ammo Packing: 15.0-7.5 mm Pitch

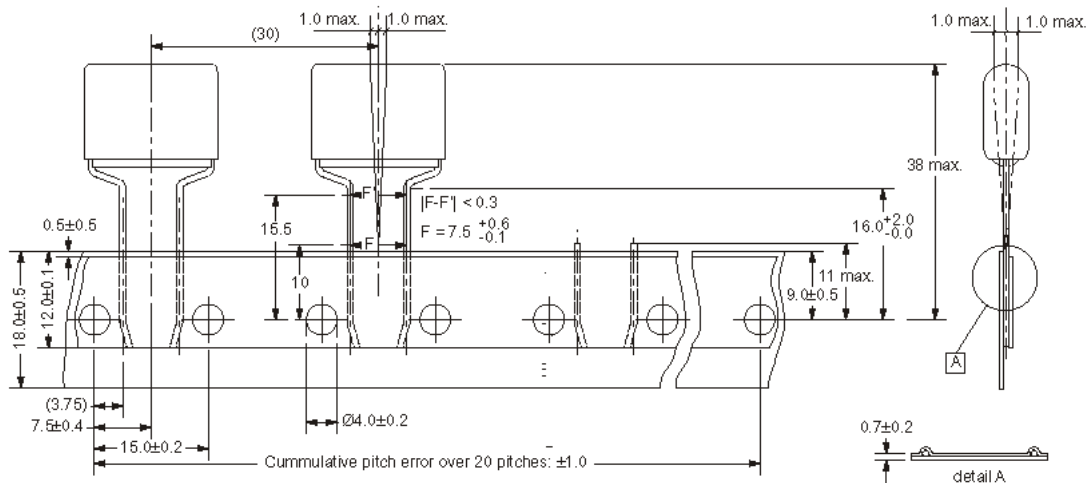

Ammo Packing: 15 mm Pitch

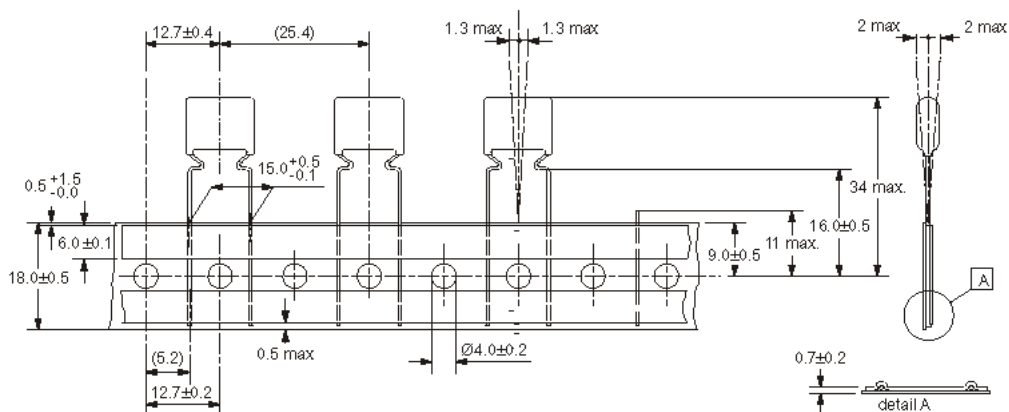

PACKING STYLES

Ammo Packing: 22.5 mm Pitch

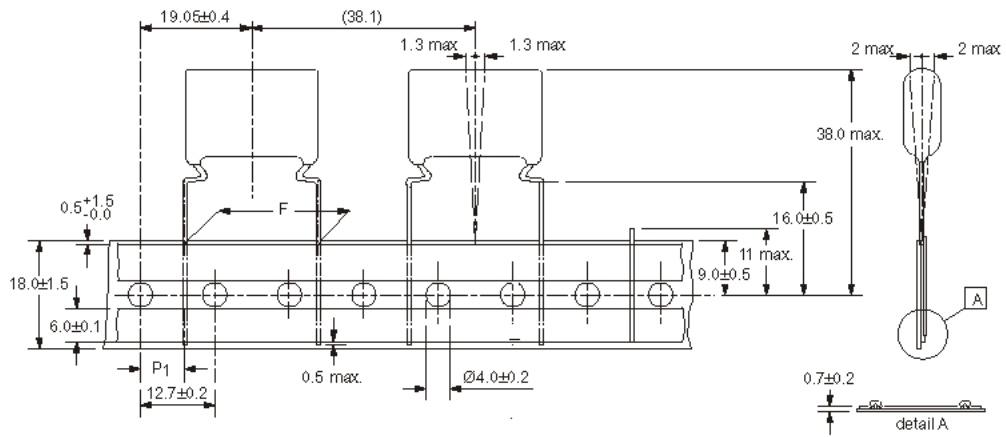

Formed and Cut Film / Foil Non-Inductive and Metallised Film Capacitors

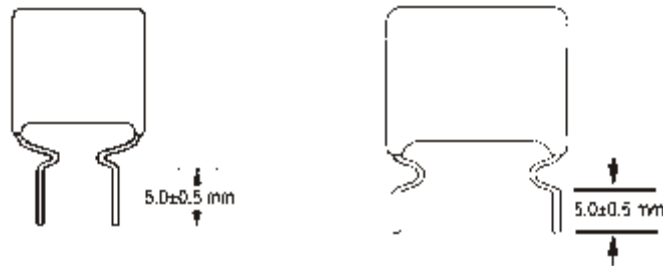

ORDERING INFORMATION

Ten digit alphanumeric code ordering system: 01 234 J 2A 1 A

1st group

Two digits (01) represent capacitor type

2nd group

Three-digit (234) indicate rated capacitance in pico farad (First two digits indicate value & third digit indicates number of zeroes to be suffixed to first two digits).

For example:

$$221 = 22 \times 10^1 = 220 \text{ pf} = 0.00022 \mu\text{f}$$

$$104 = 10 \times 10^4 = 100000 \text{ pf} = 0.1 \mu\text{f}$$

$$225 = 22 \times 10^5 = 2200000 \text{ pf} = 2.2 \mu\text{f}$$

3rd group

One letter (J) indicates capacitance tolerance

$$F = \pm 1.0\% \qquad K = \pm 10.0\%$$

$$G = \pm 2.0\% \qquad M = \pm 20.0\%$$

$$H = \pm 2.5\% \qquad N = \pm 40.0\%$$

$$I = \pm 3.5\%$$

$$J = \pm 5.0\%$$

4th group

One digit and one letter (2A) or two digits indicate rated voltage.

DC Voltage Codification - One digit and one letter

A		B		C		D		E		F		G	
1A	10	1B	12.5	1C	16	1D	20	1E	25	1F	30	1G	40
2A	100	2B	125	2C	160	2D	200	2E	250	2F	300	2G	400
3A	1000	3B	1250	3C	1600	3D	2000	3E	2500	3F	3000	3G	4000

H		I		J		K		L		M		N	
1H	50	1I	45	1J	63	1K	70	1L	80	1M	85	1N	90
2H	500	2I	450	2J	630	2K	700	2L	800	2M	850	2N	900
3H	5000	3I	4500	3J	6300	3K	7000	3L	8000	3M	8500	3N	9000

O		P		Q		R		S		T	
1O	110	1P	120	1Q	57.5	1R	15	1S	17	1T	70
2O	1100	2P	1200	2Q	575	2R	150	2S	170	2T	700
3O	11000	3P	12000	3Q	5750	3R	1500	3S	1700	3T	7000

AC Voltage Codification - Two digits

01	02	03	04	05	06	07	08
190 VAC	250 VAC	275 VAC	305 VAC	310 VAC	440 VAC	500 VAC	600 VAC
09	10	11	12	13	14	15	16
700 VAC	63 VAC	230 VAC	330 VAC	400 VAC	450 VAC	350 VAC	300 VAC

5th group

One digit (1) indicates packing type.

- 1: Bulk packing (original pitch)
- 2: Bulk Packing (after forming & cutting)
- 3: Ammo packing (after forming & taping)
- 4: Bulk Packing (after forming in original pitch without cut)
- 5: Bulk packing (after formed & without cut)
- 6: Ammo Packing (Straight lead)
- 7: Bulk Packing (Straight lead cut)
- 8: Reel Packing (Straight lead)

6th group

One letter (A) indicates drawing reference

A: As per catalogue.

B-Z: Special drawings not covered in "A" (decided by Deki)

MARKING STYLE /
SEQUENCE
(For DC Capacitors)

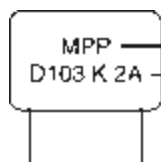

Type
Deki / Value / Tolerance / Rated Voltage
D / 103 / K / 2A

For AC Capacitors, rated voltage is indicated directly, replacing the last two alphanumeric.

A series of horizontal dotted lines for writing, filling the main body of the page.

A series of horizontal dotted lines spanning the width of the page, intended for writing or listing items.

The Deki Prayer

The day at Deki starts with a prayer. A prayer for mental strength, a prayer for a strong work ethic. The prayer, in Hindi, asks for Deki to remain ahead in quality and customer satisfaction. It seeks unending progress and learning from mistakes. The prayer wishes for self-confidence even in the face of all adversities together with good sense to spread happiness to everybody. The prayer goes on to hope for the Deki Team to have the ability to maintain the environmental balance. It ends with the invocation for each individual at Deki to become the channel to achieve all that is asked for in the prayer.

ऐसी शक्ति हमें देना दाता, मन का विश्वास कमज़ोर हो ना ।

हम करें कर्म अपना लगन से, भूल कर भी कोई भूल हो ना ॥

कर्म भूमि है डेकी हमारी, हो प्रबलता सभी के दिलों में ।

कर्म की भावना होवे ऐसी, विश्व में नाम होवे हमारा ॥

गुणवत्ता में रहें सबसे आगे, होवें संतुष्ट ग्राहक हमारे ।

प्रगति हो निरंतर हमारी, सीख लें अपनी गलतियों से ॥

सामने कितने संकट खड़े हों, ना कमी हो हमें आत्मबल की ।

देना सद्बुद्धि दाता सभी को, खुशियाँ फैलायें सबके घरों में ॥

रखें पर्यावरण संतुलन में, ऐसी सामर्थ्य होवे हमारी ।

स्वयं साधन बनें हम इसी के, लक्ष्य है हे विधाता हमारा ॥

Deki's Mission

To consistently provide customers with reliable, good quality capacitors on time at internationally competitive prices.

Quality Policy

We, at Deki, are committed to the manufacture and sale of film capacitors complying with customer requirements and to continually improve the product, process and practices.

Environmental Policy

We at Deki Electronics Limited, Noida, manufacturers of Plastic Film Capacitors in India are committed to prevent pollution and to continually improve our environmental performance by:

Conserving resources such as power, diesel, chemicals & compressed air.

Minimising emission of volatile compounds such as Xylene & Styrene.

Maximising reuse and recycling of waste packaging and plastic material.

Proper handling and disposal of inevitable wastes such as epoxy mixture, epoxy powder, used oils, cores, plastic film, aluminum foil, TPCS and TCA wire, spray wire and e-waste.

Complying with applicable environmental legislation and customer-specific list of banned substances.

Building awareness of employees on environmental issues.

This policy will be made available to the public.

All our capacitors are designed, manufactured and tested to specifications. We strictly adhere to standards in procurement of materials, in the laid down manufacturing processes and consistently apply stringent process controls and testing parameters. This ensures that our capacitors always perform to the offered specifications.

Appropriateness of use in a specific circuit and fitness to a particular application however needs to be verified. The component's reliability through its expected life time is required to be validated by the customer. Deki's responsibility is limited to ensuring that the capacitor performs as claimed in the specification/ data sheets provided by Deki. Deki specifically disclaims any implied warranties of fitness for any particular purpose. This is valid in particular for applications in which a failure or an abnormal operation of the capacitors could put at risk human life or health. Deki and all the persons acting on its behalf, disclaim any and all liabilities for possible damages resulting from the use of the products described in this catalogue or in any other publication.

In the interest of continuous improvement, Deki reserves the right to make changes from the specifications herein in the construction and design of its capacitor from time to time without notice.

Deki reserves the right to discontinue the production of any item without notice.

Deki's Diversifications

Deki is now spreading its wings and expanding into sunrise sectors like retail, energy storage and e-mobility. While the retail arm is a division that collaborates with technical leaders in their domains, the energy storage and e-mobility forays are joint-ventures with entities with a shared vision and a common philosophy.

These are the outcomes of our efforts:



IPEC India Private Limited was formed in 2017 as a joint venture between DEKI Electronics, MEHER Group and Sung Ho Electronics with a vision to become a leading provider of Power Electronics products and solutions in the areas of E-mobility and Energy Storage.

This joint venture combines a deep domain knowledge, manufacturing and business experience in the Power, Electrical and Electronics sectors.

www.i-pec.in



IPEC Drive Systems Pvt Ltd (IDS) is an Indo-Finnish partnership that is reimagining electric mobility. The company is a joint-venture between IPEC India Pvt Ltd and L7 Drive Ltd of Finland.

IDS customises, adapts and manufactures the path breaking L7 drive systems for the world's electric vehicle manufacturers.

www.ipecdrives.com

SureSolutions™ Efficiency...only better

SureSolutions™ is a division of Deki Electronics Ltd that came about to focus on the idea of "increasing business efficiency" and has remained true to it.

From retail security when SureSolutions™ started out, to immersive video today, the division has ensured that we add value to whatever it offers.

www.suresolutions.in

Deki's International Agents

Australia & New Zealand

Supreme Components International

Suite 1122, 401 Docklands Drive, **Docklands**, Victoria 3008
 Mobile:+ 65 6848 1178 Email: swraj@supremecomponents.com
 Contact Person: Mr Swraj

Brazil

Grupo Autcomp

Rua Silva Bueno, 1660 **Ipiranga**, São Paulo/SP
 Tel:+55 11 3437 7443 Email: andre.loverbeck@grupoautcomp.com.br /
 liria.araujo@grupoautcomp.com.br Website: www.grupoautcomp.com.br
 Contact Persons: Mr André Loverbeck/Mrs Liria Araujo

France

EW Solution

53 avenue Carnot, F 94230 **Cachan**
 Mobile:+33 680 219 741, Tel:+33 950 207 412
 Email: guedjf@ewsolution.eu

Germany

Contact Person: Mr Wolfram Herold
 Email: info@light-traffic.de

Capcomp GmbH

Rechbergstrasse 38/1, D-74385 **Pleidelsheim**
 Tel:+65 81026600, +65 68481178
 Email: sales.marketing@capcomp.de

Indonesia

Cluster Mapplewood E5/E17-19, Jatisampurna, **Bekasi** 17433
 Tel: +62 8157 0750 00 Email: willy@supremecomponents.com
 Contact Person: Willy

Israel

Contact Person: Mr Israel Wertheimer
 Email: israelw@rfmw.com

Malaysia

Tel: +65 6848 1178 Email: sales@supremecomponents.com

Myanmar

Tel: +65 6848 1178 Email:sales@supremecomponents.com

North America

Mobile: +65 6848 1178 Email: sales@supremecomponents.com

Philippines

Pangaea International Trading Corporation

Contact Person: Mr Noli Hernandez / Mr Chris Carunungan
 Email: noli@pangaea.com.ph / chris@pangaea.com.ph

Blk.40, Lot 33 Villa Palao Subd. Banlic, **Calamba City** 4027

Tel: +63 9178 0358 09 Email: joel.roxas@supremecomponents.com
 Contact Person: Joel

Singapore

Supreme Components International

62 Jalan Eunos, Singapore 419508, Tel:+49 7144 858535
 Email: suppih@supremecomponents.com
 Contact Person: Mr PSS Suppih

South Korea

Tel: +65 6848 1178 Email: sophia@supremecomponents.com
 Contact Person: Ms Sophia

Spain

Elcos S.L.

Contact Person: Mr Rafael Rabandan
 Email: rrabandan@elcos-rep.com

Taiwan

11F-1, No. 6, Lane 88 Dung Huang Road, **Taipei**
 Tel: +88 6936 8817 89 Email: cheryeh@supremecomponents.com
 Contact Person: Ms Cher

Thailand

35th floor, 33/4, Tower A Rama 9 Road, Huaykwang Sub-district, **Bangkok**
 Tel:+ 65 6848 1178 Email: sales@supremecomponents.com

Vietnam

Tel:+ 65 6848 1178 Email: sales@supremecomponents.com

USA

Contact Person: Mr Ashok Mazumdar
 Email: amazumdar@comcast.net



Deki's Dealer Network

North

Capco India

234 Sant Nagar, East of Kailash, **New Delhi** 110065
Tel: 011-42870182, Fax: 011-26217519, Mobile: 0-9818258886
Email: cap_india@yahoo.co.in
Contact Person: Mr Shailendra Sharma

Dewan Radios Pvt Ltd

1681/27-28 Bhagirath Palace, Chandni Chowk, **Delhi** 110006
Tel: 011-45696218, 23869312, Email: dewanradios@gmail.com
Contact Person: Mr Subhash Dewan - Mobile: 0-9811026218
Mr Kapil Khurana - Mobile: 0-9810084618

Elco Sales Corporation

D-191 Flatted Factory Complex Okhla, **New Delhi** 110020
Tel: 011-26846356, 26839523, Email: elcodelhi@hotmail.com
Contact Person: Mr S P Arora - Mobile: 0-9810360081
Mr P L Gulati - Mobile: 0-9811595656

Kapoor Trading Corporation

204 Old Lajpat Rai Market, **Delhi** 110006
Tel: +91-11-23867977, 23867991, Email: satyankapoor@yahoo.in,
satyan.kapoor@bol.net.in
Contact Person: Mr. Satyan Kapoor

Ramakrishna Electro Components Pvt Ltd

B-79, Wazirpur Industrial Area, **New Delhi** 110052.
Tel : 011-41423100, Mobile: 0-9999054559
Email: aditya@rkelectro.com, Website: www.rkelectro.com
Contact Person: Mr Aditya Shrivastava

West

Electro Enterprises

312 Bharat Bhawan 'B', 1360 Shukrawar Peth, **Pune** 411002
Tel: 020-24491394, Email: electropune@gmail.com
Contact Person: Mr Suhas Medhi

Electromark Devices (Bombay) Ltd

12/A, Hanuman Terrace Building, Tara Temple Lane, Dr DB Marg,
Mumbai 400007. Direct Line: 0-9820093325 Tel: 022-23820454,
Fax: 022-22034779, Email: mahavir@electromarkindia.com
Website: www.electromarkindia.com
Contact Person: Mr Mahavir Seth

Gtek Electro Mechanics Co.

Unit No. 101/102, Bldg. No. 33, 1st floor, Arihant Compound,
Near Kopar Bus Stop, Kopar, **Bhiwandi**, Dist. Thane 421302
Tel: 02522-276949, 0-9225133015, 0-9272233827, 0-9272233828

Email: gtek@gtekelectro.com, gteckm@gtekelectro.com
Telefax: 02522-276400, Website: www.gtekelectro.com
Contact Person: Mr Pankaj Gardi/Mr Ketan Shah

Heet Electro Devices

202 (B), 2nd Fl, 20/22 Labh Niwas Bldg, Tribhuvan Road
Off Lamington Road, Grant Road (East), **Mumbai** 400004
Tel: 022-23851319, 44812341, Mobile: 0-9867341319
Email: heetelectrodevices@gmail.com, vaibhav@heetelectrodevices.in
Contact Person: Mr Vaibhav Shah

Industrial Product Corporation

"Krushani" 1st Floor, 211 Shukrawar Peth, Nr. Akra Maruti
Pune 411002. Tel: 020-24460830, Fax: 020-24460830
Email: ipcorporation@eth.net
Contact Person: Mr Raju Kale

Radiant Electronics

202 (B), 2nd Floor, 20/22 Labh Niwas Bldg, Tribhuvan Road
Off Lamington Road, Grant Road (East), **Mumbai** 400004
Tel: 022-23851319, 33152341, 23881822
Email: radiant.electronics@gmail.com
Contact Person: Mr Vaibhav Shah

R.R. Electronics

420, 2nd Fl, Spectrum Commercial Centre, Near GPO, Relief Road,
Ahmedabad 380001. Tel: 079-255015539, 25500617
Mobile: 0-9327518749, Email: ravirrelectronics@rediffmail.com
Contact Person: Mr Ravi Raj

South

Elektronika Sales Pvt Ltd

31A Ambit Park Road, (Opp Ambit Park Gate No 3), Industrial Estate,
Ambattur South, **Chennai** 600058. Tel: 044-26251290, 26251291
Email: info @elektronikasales.com
Website: www.elektronikasales.com

Shilpa Electronics

3B Surya Towers, 105, Sardar Patel Road, **Secunderabad** 500003
Tel: 040-27849020, 27840698, Email: sales-se@shilpagroup.com
Website: www.shilpagroup.com/se
Contact Person: Mr G N Rao

SM Electronic Technologies Pvt Ltd

#2, 8th Block, Nagarabhavi 2nd Stage, Malagala, **Bengaluru** 560072.
Tel: 080-66734567, Fax: 080-66734545
Website: www.smetgroup.com